

# Real Functions in One Variable - Simple 2...

Leif Mejlbro

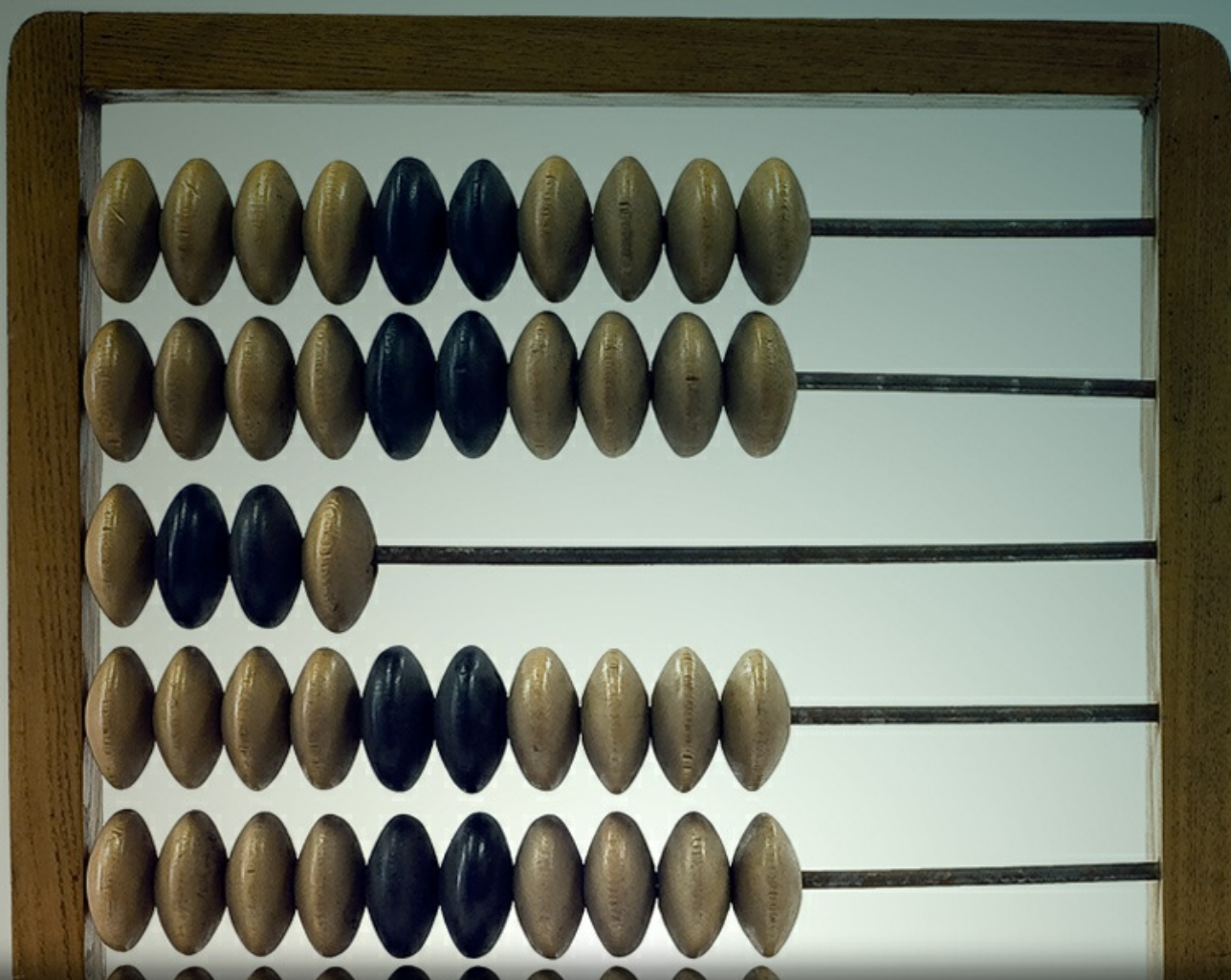

Download free books at

[bookboon.com](http://bookboon.com)

Leif Mejlbro

---

Real Functions in One Variable  
Examples of Simple Differential  
Equations II  
Calculus Analyse 1c-5

---

---

Real Functions in one Variable - Examples of Simple Differential Equations II

- Calculus 1c-5

© 2007 Leif Mejlbro & Ventus Publishing ApS

ISBN 978-87-7681-241-6

# Contents

<b>Preface</b>	<b>5</b>
<b>1 Linear differential equations of second order and of constant coefficients</b>	<b>6</b>
<b>2 Linear differential equations of higher order and of constant coefficients</b>	<b>53</b>
<b>3 Other types of linear differential equations</b>	<b>85</b>
<b>4 Mathematical models</b>	<b>87</b>

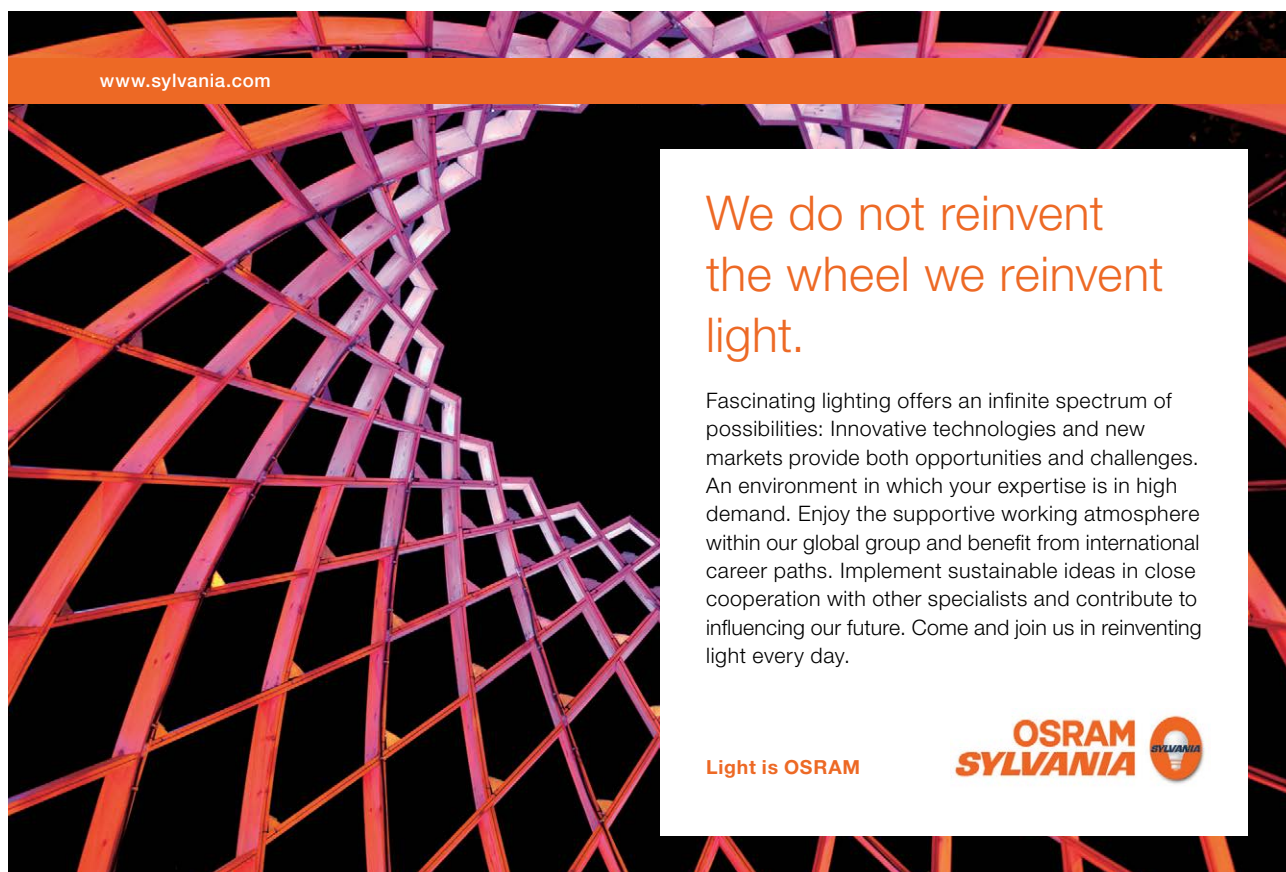

www.sylvania.com

**We do not reinvent  
the wheel we reinvent  
light.**

Fascinating lighting offers an infinite spectrum of possibilities: Innovative technologies and new markets provide both opportunities and challenges. An environment in which your expertise is in high demand. Enjoy the supportive working atmosphere within our global group and benefit from international career paths. Implement sustainable ideas in close cooperation with other specialists and contribute to influencing our future. Come and join us in reinventing light every day.

Light is OSRAM

**OSRAM  
SYLVANIA** 



## Preface

In this volume I present some examples of *Simple Differential Equations II*, cf. also *Calculus 1a, Functions of One Variable*. Since my aim also has been to demonstrate some solution strategy I have as far as possible structured the examples according to the following form

**A** *Awareness*, i.e. a short description of what is the problem.

**D** *Decision*, i.e. a reflection over what should be done with the problem.

**I** *Implementation*, i.e. where all the calculations are made.

**C** *Control*, i.e. a test of the result.

This is an ideal form of a general procedure of solution. It can be used in any situation and it is not linked to Mathematics alone. I learned it many years ago in the Theory of Telecommunication in a situation which did not contain Mathematics at all. The student is recommended to use it also in other disciplines.

One is used to from high school immediately to proceed to **I. Implementation**. However, examples and problems at university level are often so complicated that it in general will be a good investment also to spend some time on the first two points above in order to be absolutely certain of what to do in a particular case. Note that the first three points, **ADI**, can always be performed.

This is unfortunately not the case with **C Control**, because it from now on may be difficult, if possible, to check one's solution. It is only an extra securing whenever it is possible, but we cannot include it always in our solution form above.

I shall on purpose not use the logical signs. These should in general be avoided in Calculus as a shorthand, because they are often (too often, I would say) misused. Instead of  $\wedge$  I shall either write "and", or a comma, and instead of  $\vee$  I shall write "or". The arrows  $\Rightarrow$  and  $\Leftrightarrow$  are in particular misunderstood by the students, so they should be totally avoided. Instead, write in a plain language what you mean or want to do.

It is my hope that these examples, of which many are treated in more ways to show that the solutions procedures are not unique, may be of some inspiration for the students who have just started their studies at the universities.

Finally, even if I have tried to write as careful as possible, I doubt that all errors have been removed. I hope that the reader will forgive me the unavoidable errors.

Leif Mejlbro  
30th July 2007

# 1 Linear differential equations of second order and of constant coefficients

**Example 1.1** Given the differential equation

$$\frac{d^2x}{dt^2} + a_1 \frac{dx}{dt} + a_0 x = q(t), \quad t \in \mathbb{R}.$$

A student has found the solutions  $x = e^t$  and  $x = 2e^t$ , and he claims that these are the only ones. How can one from the existence and uniqueness theorem alone conclude that this statement is wrong?

- A. A theoretical question about a linear differential equation of second order.
- D. Review the existence and uniqueness theorem.
- I. According to the existence and uniqueness theorem there are for any given vector  $(t_0, x_0, v_0)$  precisely one solution  $x = \varphi(t)$ , for which

$$\varphi(t_0) = x_0, \quad \varphi'(t_0) = v_0.$$



Discover the truth at [www.deloitte.ca/careers](http://www.deloitte.ca/careers)

**Deloitte.**

© Deloitte & Touche LLP and affiliated entities.



We shall therefore be able to solve the systems of equations

$$e^{t_0} = x_0, \quad e^{t_0} = v_0,$$

or

$$2e^{t_0} = x_0, \quad 2e^{t_0} = v_0,$$

which of course cannot be done in general.

What is wrong is that the two given solutions are linearly dependent, so they only define a 1-dimensional set of solutions. The order of the equation is 2, so the set of solutions must have dimension 2. Furthermore, we have not retrieved all linear combinations of  $e^t$ , so we see that there are lots of errors in the statement above by this student.

**Example 1.2** For a differential equation of the form

$$\frac{d^2x}{dt^2} + a_1 \frac{dx}{dt} + a_0 x = q(t), \quad t \in \mathbb{R},$$

it is claimed that  $x = \sin t$  and  $x = \frac{1}{2} \sin 2t$  are both solutions. Prove from the existence and uniqueness theorem, that this is wrong.

- A. An application of the existence and uniqueness theorem.
- D. Choose  $t = 0$ , and show that  $\sin t$  and  $\frac{1}{2} \sin 2t$  take on the same value and that the same is true for their derivatives at  $t = 0$ .
- I. Let  $\varphi(t) = \sin t$  and  $\psi(t) = \frac{1}{2} \sin 2t$ . Then  $\varphi'(t) = \cos t$  and  $\psi'(t) = \cos 2t$ . For  $t = 0$  we get

$$(\varphi(0), \varphi'(0)) = (0, 1) = (\psi(0), \psi'(0)),$$

hence  $\varphi$  and  $\psi$  are two different solutions through the same line element. This is according to the existence and uniqueness theorem not possible.

**Example 1.3** Find the complete solution of the differential equation

$$\frac{d^2x}{dt^2} - 3 \frac{dx}{dt} + 2x = 0, \quad t \in \mathbb{R}.$$

- A. Linear homogeneous differential equation of second order and of constant coefficients.
- D. Start by finding the roots of the characteristic polynomial.
- I. The characteristic polynomial is

$$R^2 - 3R + 2 = (R - 1)(R - 2).$$

The roots  $R = 1$  and  $R = 2$  are simple, so the complete solution is

$$c_1 e^t + c_2 e^{2t}, \quad c_1, c_2 \in \mathbb{R}, \quad t \in \mathbb{R}.$$

**Example 1.4** Find the complete solution of the differential equation

$$\frac{d^2x}{dt^2} - 6 \frac{dx}{dt} - 16x = 0, \quad t \in \mathbb{R}.$$

- A. Linear homogeneous differential equation of second order and of constant coefficients.
- D. Find the roots of the characteristic polynomial.
- I. The characteristic polynomial

$$R^2 - 6R - 16 = (R - 3)^2 - 5^2 = (R - 8)(R + 2)$$

has the roots  $R = -2$  and  $R = 8$ . Thus, the complete solution is

$$x = c_1 e^{-2t} + c_2 e^{8t}, \quad c_1, c_2 \in \mathbb{R}, \quad t \in \mathbb{R}.$$

**Example 1.5** Find the complete solution of the differential equation

$$\frac{d^2x}{dt^2} + 2 \frac{dx}{dt} + 5x = 0, \quad t \in \mathbb{R}.$$

- A. Linear homogeneous differential equation of second order and of constant coefficients.
- D. Solve the characteristic equation.
- I. The characteristic equation  $R^2 + 2R + 5 = 0$  has the roots  $R = -1 \pm 2i$ , so the complete solution is

$$x = c_1 e^{-t} \cos 2t + c_2 e^{-t} \sin 2t, \quad c_1, c_2 \in \mathbb{R}, \quad t \in \mathbb{R}.$$

**Example 1.6** Find the complete solution of the differential equation

$$\frac{d^2x}{dt^2} - 2 \frac{dx}{dt} + 17x = 0, \quad t \in \mathbb{R}.$$

- A. Linear homogeneous differential equation of second order and of constant coefficients.
- D. Solve the characteristic equation and set up the solution.
- I. Obviously, the characteristic polynomial  $R^2 - 2R + 17$  has the two simple roots  $R = 1 \pm 4i$ . Thus, the complete solution is

$$x = c_1 e^t \cos 4t + c_2 e^t \sin 4t, \quad c_1, c_2 \in \mathbb{R}, \quad t \in \mathbb{R}.$$



**Example 1.7** Find the complete solution of the differential equation

$$\frac{d^2x}{dt^2} - 3 \frac{dx}{dt} + 2x = 0, \quad t \in \mathbb{R}.$$

- A.** Linear homogeneous differential equation of second order and of constant coefficients. This example is almost identical with Example 1.3, the only difference being that we here require all the *complex* solutions.
- D.** Apply Example 1.3, or find the roots of the characteristic polynomial.
- I.** The characteristic polynomial  $R^2 - 3R + 2$  has the two simple roots  $R = 1$  and  $R = 2$ . Thus, all *complex* solutions are

$$x = c_1 e^t + c_2 e^{2t}, \quad c_1, c_2 \in \mathbb{C}, \quad t \in \mathbb{R}.$$

**Example 1.8** Find the complete solution of the differential equation

$$\frac{d^2x}{dt^2} - 6 \frac{dx}{dt} + 9x = 0, \quad t \in \mathbb{R}.$$

- A.** Linear homogeneous differential equation of second order and of constant coefficients.
- D.** Solve the characteristic equation, and then set up the solution.
- I.** The characteristic equation  $R^2 - 6R + 9 = (R - 3)^2$  has the double root  $R = 3$ , hence, the complete solution is

$$x = c_1 e^{3t} + c_2 t e^{3t}, \quad c_1, c_2 \in \mathbb{R}, \quad t \in \mathbb{R}.$$

**Example 1.9** Consider the differential equation

$$(1) \quad c \frac{d^2x}{dt^2} - 2 \frac{dx}{dt} + x = 0,$$

where  $c$  is a positive real number.

- 1) Find for  $0 < c < 1$  that solution  $x = \varphi_c(t)$  of (1), for which  $\varphi_c(0) = 1$  and  $\varphi'_c(0) = 1$ .
- 2) Find for  $c = 1$  that solution  $x = \varphi_1(t)$  of (1), for which  $\varphi_1(0) = 1$  and  $\varphi'_1(0) = 1$ .
- 3) Let  $t \in \mathbb{R}$  be fixed. Is it true that  $\varphi_c(t) \rightarrow \varphi_1(t)$ , when  $c \rightarrow 1$ ?

- A.** Linear homogeneous differential equation of second order and of constant coefficients, where one of the coefficients can change independently of  $t$ . Check the behaviour of a solution during a limit process with respect to this coefficient (a parameter).
- D.** For given  $c$  we find the roots of the characteristic equation. Then set up the solution.
- I.** The characteristic equation  $cR^2 - 2R + 1 = 0$ ,  $c > 0$ , has the solutions

$$R = \frac{1}{2c} \{2 \pm \sqrt{4 - 4c}\} = \frac{1 \pm \sqrt{1 - c}}{c}.$$

1) When  $0 < c < 1$ , then the complete solution is

$$x = c_1 \exp\left(\frac{1 + \sqrt{1-c}}{c} t\right) + c_2 \exp\left(\frac{1 - \sqrt{1-c}}{c} t\right), \quad c_1, c_2 \in \mathbb{R},$$

where

$$\begin{aligned} x'(t) = & c_1 \cdot \frac{1 + \sqrt{1-c}}{c} \cdot \exp\left(\frac{1 + \sqrt{1-c}}{c} t\right) \\ & + c_2 \cdot \frac{1 - \sqrt{1-c}}{c} \cdot \exp\left(\frac{1 - \sqrt{1-c}}{c} t\right). \end{aligned}$$

Thus

$$\varphi_c(0) = 1 = c_1 + c_2, \quad \varphi'_c(0) = 1 = c_1 \cdot \frac{1 + \sqrt{1-c}}{c} + c_2 \cdot \frac{1 - \sqrt{1-c}}{c},$$

i.e.  $c_2 = 1 - c_1$ , and

$$1 = c_1 \cdot \frac{1 + \sqrt{1-c}}{c} + (1 - c_1) \cdot \frac{1 - \sqrt{1-c}}{c} = \frac{1 - \sqrt{1-c}}{c} + c_1 \cdot \frac{2\sqrt{1-c}}{c},$$

SIMPLY CLEVER

ŠKODA



We will turn your CV into  
an opportunity of a lifetime



Do you like cars? Would you like to be a part of a successful brand?  
We will appreciate and reward both your enthusiasm and talent.  
Send us your CV. You will be surprised where it can take you.

Send us your CV on  
[www.employerforlife.com](http://www.employerforlife.com)



Click on the ad to read more

hence

$$c_1 = \frac{c}{2\sqrt{1-c}} \left\{ 1 - \frac{1 - \sqrt{1-c}}{c} \right\} = \frac{c - 1 + \sqrt{1-c}}{2\sqrt{1-c}} = \frac{1}{2} \{1 - \sqrt{1-c}\},$$

and

$$c_2 = 1 - c_1 = \frac{1}{2} \{1 + \sqrt{1-c}\},$$

and we get

$$(2) \quad \varphi_c(t) = \frac{1}{2}(1 - \sqrt{1-c}) \exp\left(\frac{1 + \sqrt{1-c}}{c} t\right) + \frac{1}{2}(1 + \sqrt{1-c}) \exp\left(\frac{1 - \sqrt{1-c}}{c} t\right).$$

- 2) When  $c = 1$ , then the characteristic equation  $R^2 - 2R + 1 = (R - 1)^2 = 0$ , has the double root  $R = 1$ . The complete solution is

$$x = c_1 e^t + c_2 t e^t \quad \text{where} \quad \frac{dx}{dt} = (c_1 + c_2) e^t + c_2 t e^t.$$

It follows from

$$\varphi_1(0) = 1 = c_1 \quad \text{and} \quad \varphi_1'(0) = 1 = c_1 + c_2,$$

that  $c_1 = 1$  and  $c_2 = 0$ , so the solution is

$$\varphi_1(t) = e^t.$$

- 3) We get by the limit process  $c \rightarrow 1-$  in (2),

$$\lim_{c \rightarrow 1-} \varphi_c(t) = \frac{1}{2} e^t + \frac{1}{2} e^t = e^t = \varphi_1(t),$$

so we obtain  $\varphi_1(t)$  by this limit process.

**Example 1.10** Consider the differential equation

$$\frac{d^2 x}{dt^2} + a_1 \frac{dx}{dt} + a_0 x = q(t), \quad t \in \mathbb{R}.$$

We get the extra information that the functions

$$\sin t + 2e^t \quad \text{and} \quad \sin t + e^t - e^{-t}$$

are both solutions. Find the complete solution based on this information.

- A.** Linear inhomogeneous differential equation of second order and of constant, though unknown coefficients. However, we are given two solutions. Find the complete solution.
- D.** When we take the difference of the two solutions, we get a solution of the corresponding homogeneous equation. Put this into the left hand side of the equation.

I. The subtraction gives that

$$2\varphi_1(t) = (\sin t + 2e^t) - (\sin t + e^t - e^{-t}) = e^t + e^{-t} = 2 \cosh t$$

is a solution of the corresponding homogeneous equation, thus

$$\varphi_1(t) = \cosh t$$

is also a solution. Then by insertion into the left hand side of the equation we get

$$\frac{d^2\varphi_1}{dt^2} + a_1 \frac{d\varphi_1}{dt} + a_0 \varphi_1(t) = (a_0 + 1) \cosh t + a_1 \sinh t = 0.$$

Now,  $\cosh t$  and  $\sinh t$  are linearly independent, so we must have  $a_0 = -1$  and  $a_1 = 0$ . We have now reduced the equation to

$$\frac{d^2x}{dt^2} - x = q(t).$$

Then the complete solution of the corresponding homogeneous equation is given by

$$c_1 \cosh t + c_2 \sinh t, \quad c_1, c_2 \in \mathbb{R}.$$

Then we insert the solution  $\sin t + 2e^t$ , which gives that

$$q(t) = -\sin t - \sin t = -2 \sin t,$$

and the equation is

$$\frac{d^2x}{dt^2} - x = -2 \sin t,$$

and its complete solution is

$$x = -2 \sin t + c_1 \cosh t + c_2 \sinh t, \quad c_1, c_2 \in \mathbb{R}, \quad t \in \mathbb{R}.$$

**Example 1.11** Consider the differential equation

$$\frac{d^2x}{dt^2} + a_1 \frac{dx}{dt} + a_0 x = q(t), \quad t \in \mathbb{R},$$

where we get the information that the functions

$$t^2 + e^{-t} \cos t \quad \text{and} \quad t^2$$

are both solutions. Find the coefficients  $a_1$  and  $a_0$ , and the function  $q(t)$ .

**A.** Linear inhomogeneous differential equation of second order and of constant, though unknown coefficients. There are given two solutions. One shall find the constants and the right hand side  $q(t)$ .

**D.** First find a solution of the corresponding homogeneous equation. When this is put into the homogeneous equation we derive  $a_1$  and  $a_0$ . Finally, insert  $t^2$  in order to get  $q(t)$ .

- I. The equation is linear, so the difference  $x = e^{-t} \cos t$  must be a solution of the corresponding homogeneous equation. From

$$x = e^{-t} \cos t, \quad \frac{dx}{dt} = -e^{-t}(\cos t + \sin t), \quad \frac{d^2x}{dt^2} = 2e^{-t} \sin t,$$

we get

$$\frac{d^2x}{dt^2} + a_1 \frac{dx}{dt} + a_0 x = (-a_1 + a_0)e^{-t} \cos t + (2 - a_1)e^{-t} \sin t = 0.$$

Now,  $e^{-t} \cos t$  and  $e^{-t} \sin t$  are linearly independent, so we must necessarily have  $-a_1 + a_0 = 0$  and  $2 - a_1 = 0$ , and thus  $a_0 = a_1 = 2$ . The equation can now be written

$$\frac{d^2x}{dt^2} + 2 \frac{dx}{dt} + 2x = q(t).$$

By insertion of  $x = t^2$  we get

$$q(t) = 2t^2 + 4t + 2 = 2(t + 1)^2,$$

and the equation becomes

$$\frac{d^2x}{dt^2} + 2 \frac{dx}{dt} + 2x = 2(t + 1)^2.$$

The corresponding complete solution is

$$x = t^2 + c_1 e^{-t} \cos t + c_2 e^{-t} \sin t, \quad c_1, c_2 \in \mathbb{R}, \quad t \in \mathbb{R}.$$

**Example 1.12** Find the complete solution of the differential equation

$$\frac{d^2x}{dt^2} + 3 \frac{dx}{dt} + 2x = e^t, \quad t \in \mathbb{R}.$$

- A. Linear inhomogeneous differential equation of second order and of constant coefficients.  
 D. Find the roots of the characteristic equation. Then guess a particular solution.  
 I. The characteristic polynomial  $R^2 + 3R + 2 = (R + 1)(R + 2)$  has the simple roots  $R = -1$  and  $R = -2$ . The corresponding homogeneous equation therefore has the complete solution

$$c_1 e^{-t} + c_2 e^{-2t}, \quad c_1, c_2 \in \mathbb{R}, \quad t \in \mathbb{R}.$$

Since the right hand side is *not* a solution of the homogeneous equation, we guess a particular solution of the form  $x = c \cdot e^t$ . Then by insertion

$$\frac{d^2x}{dt^2} + 3 \frac{dx}{dt} + 2x = 6c e^t.$$

This expression is equal to  $e^t$  for  $c = \frac{1}{6}$ . Thus, the complete solution is

$$x = \frac{1}{6} e^t + c_1 e^{-t} + c_2 e^{-2t}, \quad c_1, c_2 \in \mathbb{R}, \quad t \in \mathbb{R}.$$

**Example 1.13** Find the complete solution of the differential equation

$$\frac{d^2x}{dt^2} - 6\frac{dx}{dt} + 9x = t^3, \quad t \in \mathbb{R}.$$

- A. Linear inhomogeneous differential equation of second order and of constant coefficients.
- D. Find the roots of the characteristic polynomial and then the complete solution of the corresponding homogeneous equation. Then guess a polynomial of third degree as a particular integral.
- I. The characteristic equation  $R^2 - 6R + 9 = (R - 3)^2 = 0$  has the double root  $R = 3$ , hence the corresponding homogeneous equation has the complete solution

$$x = c_1e^{3t} + c_2te^{3t}, \quad c_1, c_2 \in \mathbb{R}, \quad t \in \mathbb{R}.$$

When we put  $x = at^3 + bt^2 + ct + d$  into the left hand side of the equation, we get

$$\begin{aligned} \frac{d^2x}{dt^2} - 6\frac{dx}{dt} + 9x &= 9(at^3 + bt^2 + ct + d) - 6(3at^2 + 2bt + c) + (6at + 2b) \\ &= 9at^3 + (9b - 18a)t^2 + (9c - 12b + 6a)t + (9d - 6c + 2b). \end{aligned}$$

I joined MITAS because  
I wanted **real responsibility**

The Graduate Programme  
for Engineers and Geoscientists  
[www.discovermitas.com](http://www.discovermitas.com)



Real work  
International opportunities  
Three work placements



**Month 16**  
I was a construction  
supervisor in  
the North Sea  
advising and  
helping foremen  
solve problems



This is equal to  $t^3$ , if

$$9a = 1, \quad 9b - 18a = 0, \quad 9c - 12b + 6a = 0, \quad 9d - 6c + 2b = 0,$$

hence

$$a = \frac{1}{9}, \quad b = \frac{2}{9}, \quad c = \frac{2}{9}, \quad d = \frac{8}{81}.$$

The complete solution is

$$x = \frac{1}{9}t^3 + \frac{2}{9}t^2 + \frac{2}{9}t + \frac{8}{81} + c_1e^{3t} + c_2te^{3t}, \quad c_1, c_2 \in \mathbb{R}, \quad t \in \mathbb{R}.$$

**Example 1.14** Find the complete complex solution of the differential equation

$$\frac{d^2x}{dt^2} - 3\frac{dx}{dt} + 2x = 2t^2 + 3, \quad t \in \mathbb{R}.$$

- A.** Linear inhomogeneous differential equation of second order and of constant coefficients.  
**D.** Find the roots of the characteristic polynomial; guess a polynomial as a particular solution.  
**I.** The characteristic polynomial  $R^2 - 3R + 2 = (R - 1)(R - 2)$  has the simple and real roots  $R = 1$  and  $R = 2$ . The complete solution of the homogeneous equation is then given by

$$c_1e^t + c_2e^{2t}, \quad c_1, c_2 \in \mathbb{C}, \quad t \in \mathbb{R},$$

cf. Example 1.3 or Example 1.7.

When  $x = at^2 + bt + c$  is put into the left hand side of the equation, we get

$$\begin{aligned} \frac{d^2x}{dt^2} - 3\frac{dx}{dt} + 2x &= 2(at^2 + bt + c) - 3(2at + b) + 2a \\ &= 2at^2 + (2b - 6a)t + (2c - 3b + 2a). \end{aligned}$$

This is equal to  $2t^2 + 3$ , when

$$2a = 2, \quad 2b - 6a = 0, \quad 2c - 3b + 2a = 3.$$

Thus  $a = 1$ ,  $b = 3$  and  $c = 5$ . The complete solution is

$$x = t^2 + 3t + 5 + c_1e^t + c_2e^{2t}, \quad c_1, c_2 \in \mathbb{C}, \quad t \in \mathbb{R}.$$

**Example 1.15** Find the complete solution of the differential equation

$$\frac{d^2x}{dt^2} - 2\frac{dx}{dt} + 5x = \cos t, \quad t \in \mathbb{R}.$$

Write a MAPLE programme, which sketches the graph of one of the solutions of the differential equation.

- A.** Linear inhomogeneous differential equation of second order and of constant coefficients.  
**D.** Solve the characteristic equation. Insert the complex “guess”  $c \cdot e^{it}$ , and find the real part.

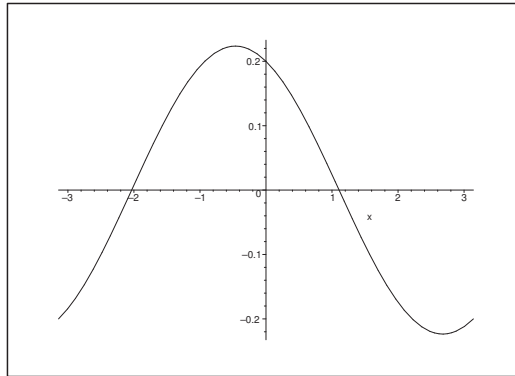

Figure 1: The graph of  $\frac{1}{10} \{2 \cos t - \sin t\}$ .

- I.** The characteristic equation  $R^2 - 2R + 5 = 0$  has the roots  $R = 1 \pm 2i$ . Thus, the corresponding homogeneous equation has the complete solution

$$c_1 e^t \cos 2t + c_2 e^t \sin 2t, \quad c_1, c_2 \in \mathbb{R}, \quad t \in \mathbb{R}.$$

When  $x = c \cdot e^{it}$ , we get

$$\begin{aligned} \frac{d^2x}{dt^2} - 2\frac{dx}{dt} + 5x &= c \cdot i^2 \cdot e^{it} - 2c \cdot i e^{it} + 5c \cdot e^{it} \\ &= c(4 - 2i)e^{it}, \end{aligned}$$

which is equal to  $e^{it}$  when  $c = \frac{1}{4 - 2i} = \frac{1}{10}(2 + i)$ . Hence, if

$$x = \operatorname{Re} \left\{ \frac{1}{10}(2 + i)e^{it} \right\} = \frac{1}{10} \{2 \cos t - \sin t\}$$

is inserted into the left hand side of the equation we get the result  $\operatorname{Re} e^{it} = \cos t$ . The complete solution is

$$x = \frac{1}{10} \{2 \cos t - \sin t\} + c_1 e^t \cos 2t + c_2 e^t \sin 2t, \quad t \in \mathbb{R},$$

where  $c_1, c_2 \in \mathbb{R}$  are arbitrary constants.



We shall give a MAPLE programme of sketching the graph of the most obvious particular solution, namely

$$\frac{1}{10} \{2 \cos t - \sin t\} = \frac{1}{5} \cos t - \frac{1}{10} \sin t.$$

MAPLE programmes are rarely unique. Here, I have used the commands

```
plot(cos(x)/5-sin(x)/(10),x=-Pi..Pi,color=black);
```

Notice that the scales are different on the axis.

We note that

$$\frac{1}{10} \{2 \cos t - \sin t\} = \frac{\sqrt{5}}{10} \left\{ \frac{2}{\sqrt{5}} \cos t - \frac{1}{\sqrt{5}} \sin t \right\} = \frac{1}{2\sqrt{5}} \cos(t + \varphi),$$

where

$$\cos \varphi = \frac{2}{\sqrt{5}} \quad \text{og} \quad \sin \varphi = \frac{1}{\sqrt{5}}.$$

Hence the particular solution is a pure sinus oscillation of period  $2\pi$  and of modulus  $\frac{1}{2\sqrt{5}}$  and the phase shift.

**Example 1.16** Find the solution  $x = \varphi(t)$  of the differential equation

$$\frac{d^2x}{dt^2} + 2 \frac{dx}{dt} + 2x = -5 \sin t, \quad t \in \mathbb{R},$$

for which  $\varphi(0) = 0$  and  $\varphi'(0) = 1$ .

- A.** Linear inhomogeneous differential equation of second order and of constant coefficients.  
**D.** Solve the characteristic equation and put  $x = c \cdot e^{it}$ .  
**I.** The characteristic equation  $R^2 + 2R + 2 = 0$  has the roots  $R = -1 \pm i$ , so the complete solution of the homogeneous equation is

$$c_1 e^{-t} \cos t + c_2 e^{-t} \sin t, \quad c_1, c_2 \in \mathbb{R}, \quad t \in \mathbb{R}.$$

If  $x = c \cdot e^{it}$  is put into the left hand side of the equation, we get

$$\frac{d^2x}{dt^2} + 2 \frac{dx}{dt} + 2x = c(-1 + 2i + 1)e^{it} = c(1 + 2i)e^{it},$$

which is equal to  $-5e^{it}$  for  $c = -\frac{5}{1 + 2i} = -1 + 2i$ . Hence we insert

$$x = \text{Im}\{(-1 + 2i)(\cos t + i \sin t)\} = 2 \cos t - \sin t,$$

from which we get  $\text{Im}\{-5e^{it}\} = -5 \sin t$ , and the complete solution is

$$\varphi(t) = 2 \cos t - \sin t + c_1 e^{-t} \cos t + c_2 e^{-t} \sin t, \quad c_1, c_2 \in \mathbb{R}, \quad t \in \mathbb{R},$$

so

$$\varphi'(t) = -\cos t - 2\sin t + (-c_1 + c_2)e^{-t}\cos t + (-c_1 - c_2)e^{-t}\sin t.$$

It follows from the initial conditions that

$$\begin{aligned}\varphi(0) = 0 &= 2 + c_1, & \text{dvs. } c_1 &= -2, \\ \varphi'(0) = 1 &= -1 - c_1 + c_2, & \text{dvs. } c_2 &= 0.\end{aligned}$$

Thus, the wanted solution is

$$\varphi(t) = 2\cos t - \sin t - 2e^{-t}\cos t.$$

**ie** business school

#1 EUROPEAN BUSINESS SCHOOL  
FINANCIAL TIMES 2013

#gobeyond

**MASTER IN MANAGEMENT**

Because achieving your dreams is your greatest challenge. IE Business School's Master in Management taught in English, Spanish or bilingually, trains young high performance professionals at the beginning of their career through an innovative and stimulating program that will help them reach their full potential.

- Choose your area of specialization.
- Customize your master through the different options offered.
- Global Immersion Weeks in locations such as London, Silicon Valley or Shanghai.

*Because you change, we change with you.*

www.ie.edu/master-management | mim.admissions@ie.edu |



**Example 1.17** Find a solution of each of the differential equations below:

$$1) \frac{d^2x}{dt^2} - 3 \frac{dx}{dt} + 2x = e^{-t}, \quad t \in \mathbb{R}.$$

$$2) \frac{d^2x}{dt^2} - 3 \frac{dx}{dt} + 2x = 1 + t, \quad t \in \mathbb{R}.$$

$$3) \frac{d^2x}{dt^2} - 3 \frac{dx}{dt} + 2x = e^{-t} + 1 + t, \quad t \in \mathbb{R}.$$

**A.** On the left hand side we have the same linear differential operator of second order and of constant coefficients. Notice that it is the same differential operator as in Example 1.3, Example 1.7 and Example 1.14.

The three right hand sides are different, though (3) is obtained by an addition of (1) and (2), so we can get a solution of (3) by superposition.

**D.** In all three cases we are only requested to give one solution. Start by solving the characteristic equation, and then give the complete solution of the homogeneous equation. Finally, guess systematically a particular solution.

**I.** The characteristic polynomial  $R^2 - 3R + 2 = (R - 1)(R - 2)$  has the simple roots  $R = 1$  and  $R = 2$ , so the complete solution of the homogeneous equation is

$$c_1 e^t + c_2 e^{2t}, \quad c_1, c_2 \in \mathbb{R}, \quad t \in \mathbb{R}.$$

1) When we put  $x = c \cdot e^{-t}$  into the left hand side of the equation, we get

$$\frac{d^2x}{dt^2} - 3 \frac{dx}{dt} + 2x = c(1 + 3 + 2)e^{-t} = 6ce^{-t} = e^{-t}$$

for  $c = \frac{1}{6}$ . The complete solution is

$$x = \frac{1}{6} e^{-t} + c_1 e^t + c_2 e^{2t}, \quad c_1, c_2 \in \mathbb{R}, \quad t \in \mathbb{R}.$$

2) When we put  $x = at + b$  into the left hand side of the equation, we get

$$\frac{d^2x}{dt^2} - 3 \frac{dx}{dt} + 2x = -3a + 2at + 2b = 2at + (2b - 3a),$$

which is equal to  $1 + t$  for  $a = \frac{1}{2}$  and  $b = \frac{5}{4}$ . The complete solution is

$$x = \frac{1}{2} t + \frac{5}{4} + c_1 e^t + c_2 e^{2t}, \quad c_1, c_2 \in \mathbb{R}, \quad t \in \mathbb{R}.$$

3) Due to the linearity and the results of (1) and (2) we immediately get the complete solution

$$x = \frac{1}{2} t + \frac{5}{4} + \frac{1}{6} e^{-t} + c_1 e^t + c_2 e^{2t}, \quad c_1, c_2 \in \mathbb{R}, \quad t \in \mathbb{R}.$$

**Example 1.18** Find a solution of each of the differential equations below:

$$1) \frac{d^2x}{dt^2} + 4 \frac{dx}{dt} + 8x = e^{2t} \cos 2t, \quad t \in \mathbb{R}.$$

$$2) \frac{d^2x}{dt^2} + 4 \frac{dx}{dt} + 8x = \cos t, \quad t \in \mathbb{R}.$$

$$3) \frac{d^2x}{dt^2} + 4 \frac{dx}{dt} + 8x = 2e^{2t} \cos 2t - 3 \cos t, \quad t \in \mathbb{R}.$$

**A.** Linear inhomogeneous differential equation of second order and of constant coefficients. The same homogeneous equation. Only one solution is wanted in each case.

**D.** Even if it is not requested, we shall nevertheless find the complete solution of the homogeneous equation. Then:

1) Put  $x = c \cdot e^{(2+2i)t}$ , and take the real part.

2) Put  $x = c \cdot e^{it}$ , and take the real part.

3) Choose some linear combination of the solutions of (1) and (2).

**I.** The (simple) roots of the characteristic polynomials  $R^2 + 4R + 8 = (R + 2)^2 + 2^2$  are  $R = -2 \pm 2i$ , hence the homogeneous equation has the complete solution

$$c_1 e^{-2t} \cos 2t + c_2 e^{-2t} \sin 2t, \quad c_1, c_2 \in \mathbb{R}, \quad t \in \mathbb{R}.$$

1) If we put

$$x = c \cdot e^{(2+2i)t} = c \cdot e^{2(1+i)t}$$

into the left hand side of the equation, we get

$$\begin{aligned} \frac{d^2x}{dt^2} + 4 \frac{dx}{dt} + 8x &= c \{2^2(1+i)^2 + 4 \cdot 2(1+i) + 8\} e^{(2+2i)t} \\ &= c \{4i + 8 + 4i + 8\} e^{(2+2i)t} = 8c(2+i) e^{(2+2i)t}, \end{aligned}$$

which is equal to  $e^{2(1+i)t}$  for  $c = \frac{1}{8} \cdot \frac{1}{2+i} = \frac{2-i}{40}$ . Thus, a solution is

$$\operatorname{Re} \left\{ \frac{1}{40} (2-i) e^{(2+2i)t} \right\} = \frac{1}{40} e^{2t} \{2 \cos 2t + \sin 2t\}.$$

2) When we put  $x = c \cdot e^{it}$  into the left hand side of the equation, we get

$$\frac{d^2x}{dt^2} + 4 \frac{dx}{dt} + 8x = c(-1 + 4i + 8) e^{it} = c(7 + 4i) e^{it},$$

which is equal to  $e^{it}$  for  $c = \frac{1}{7+4i} = \frac{1}{65} (7-4i)$ . Hence a solution is

$$\operatorname{Re} \left\{ \frac{1}{65} (7-4i) e^{it} \right\} = \frac{1}{65} \{7 \cos t + 4 \sin t\}.$$

3) Since  $2e^{2t} \cos 2t - 3 \cos t$  is equal to two times the right hand side of (1) minus three times the right hand side of (2), it follows from the linearity that a solution is given by

$$\frac{1}{20} e^{2t} \{2 \cos 2t + \sin 2t\} - \frac{3}{65} \{7 \cos t + 4 \sin t\}.$$

In all three cases we obtain the complete solution by adding all solutions of the homogeneous equation to the particular solution.

**Example 1.19** Find the complete solution of the differential equation

$$\frac{d^2x}{dt^2} - 3 \frac{dx}{dt} - 4x = -\sin t + e^{2t} + 1, \quad t \in \mathbb{R}.$$

A. Linear inhomogeneous differential of second order and of constant coefficients.

D. Find the roots of the characteristic polynomial and thus find the complete solution of the homogeneous equation. Then guess systematically a particular solution of the inhomogeneous equation, and finally use superposition.

I. The characteristic polynomial  $R^2 - 3R - 4$  has the roots

$$R = \frac{1}{2} \{3 \pm \sqrt{9 + 4 \cdot 4}\} = \frac{1}{2} \{3 \pm 5\} = \begin{cases} 4, \\ -1, \end{cases}$$

hence the homogeneous equation has the complete solution

$$c_1 e^{-t} + c_2 e^{4t}, \quad c_1, c_2 \in \mathbb{R}, \quad t \in \mathbb{R}.$$

If we put  $x = c \cdot e^{it}$ , we get

$$\frac{d^2x}{dt^2} - 3 \frac{dx}{dt} - 4x = c(-1 - 3i - 4)e^{it} = c(-5 - 3i)e^{it},$$

which is equal to  $-e^{it}$  for  $c = \frac{1}{5 + 3i} = \frac{5 - 3i}{34}$ . We therefore obtain the result  $-\sin t = \text{Im}(-e^{it})$  for

$$x = \text{Im} \left\{ \frac{5 - 3i}{34} \cdot e^{it} \right\} = \frac{1}{34} \{5 \sin t - 3 \cos t\}.$$

If we put  $x = c \cdot e^{2t}$ , we get

$$\frac{d^2x}{dt^2} - 3 \frac{dx}{dt} - 4x = c(4 - 3 \cdot 2 - 4)e^{2t} = -6ce^{2t} = e^{2t}$$

for  $c = -\frac{1}{6}$ . We obtain the result  $e^{2t}$  for  $x = -\frac{1}{6} e^{2t}$ .

If we put  $x = -\frac{1}{4}$ , we get the result 1.

From the linearity we conclude that the complete solution is given by

$$\frac{1}{34} \{5 \sin t - 3 \cos t\} - \frac{1}{6} e^{2t} - \frac{1}{4} + c_1 e^{-t} + c_2 e^{4t}, \quad t \in \mathbb{R},$$

where  $c_1, c_2 \in \mathbb{R}$  are arbitrary constants.

**Example 1.20** Consider a differential equation

$$\frac{d^2x}{dt^2} + \frac{dx}{dt} - 6x = q(t), \quad t \in \mathbb{R}.$$

Prove that there for any given numbers  $a, b \in \mathbb{R}$  exists precisely one solution  $x = \varphi(t)$  of the differential equation, for which  $\varphi(0) = a$  and  $\varphi(1) = b$ .

- A.** Boundary value problem for a linear inhomogeneous differential equation of second order and of constant coefficients, where the right hand side has not been specified.
- D.** Find the complete solution of the homogeneous equation and apply the structure of the set of solutions. Finally, show that the solution is uniquely determined by the conditions.
- I.** The characteristic equation  $R^2 + R - 6 = 0$  has the simple roots  $R = 2$  and  $R = -3$ . Let  $\varphi_0(t)$  be any particular solution of the inhomogeneous equation. Then the complete solution is given by

$$\varphi(t) = \varphi_0(t) + c_1e^{2t} + c_2e^{-3t}, \quad c_1, c_2 \in \mathbb{R}, \quad t \in \mathbb{R}.$$



**no.1**  
nine years  
in a row

Syeden  
Stockholm

## STUDY AT A TOP RANKED INTERNATIONAL BUSINESS SCHOOL

Reach your full potential at the Stockholm School of Economics, in one of the most innovative cities in the world. The School is ranked by the Financial Times as the number one business school in the Nordic and Baltic countries.

Visit us at [www.hhs.se](http://www.hhs.se)





Then insert the boundary conditions (this only means that we shall insert different values of  $t$ , here  $t = 0$  and  $t = 1$ ),

$$\begin{cases} \varphi(0) = a = \varphi_0(0) + c_1 + c_2, \\ \varphi(1) = b = \varphi_0(1) + c_1 e^2 + c_2 e^{-3}, \end{cases}$$

From these equations we get the following system of linear equations for the constants  $c_1$  and  $c_2$ ,

$$\begin{cases} e^2 c_1 + e^{-3} c_2 = b - \varphi_0(1), \\ c_1 + c_2 = a - \varphi_0(0). \end{cases}$$

Since

$$\begin{vmatrix} e^2 & e^{-3} \\ 1 & 1 \end{vmatrix} = e^2 - e^{-3} \neq 0,$$

we conclude that to any given constants  $a, b \in \mathbb{R}$  there is one and only one solution  $(c_1, c_2) \in \mathbb{R}^2$ , and the claim is proved.

**Example 1.21** Consider a differential equation

$$\frac{d^2 x}{dt^2} - 4 \frac{dx}{dt} + 5x = q(t), \quad t \in \mathbb{R}.$$

Prove that for any given constants  $a, b \in \mathbb{R}$  there exists precisely one solution  $x = \varphi(t)$  of the differential equation, for which  $\varphi(0) = a$  and  $\varphi(1) = b$ .

- A.** Boundary value problem for a linear inhomogeneous differential equation of second order and of constant coefficients, where the right hand side has not been specified.
- D.** Find the roots of the characteristic polynomial and apply the structure of the complete solution. Then insert the boundary conditions and prove that the solution is unique.
- I.** The characteristic polynomial  $R^2 - 4R + 5$  has the two simple roots  $2 \pm i$ . Therefore, if  $\varphi_0(t)$  is any particular solution, then the complete solution of the inhomogeneous differential equation is given by

$$\varphi(t) = \varphi_0(t) + c_1 e^{2t} \cos t + c_2 e^{2t} \sin t, \quad c_1, c_2 \in \mathbb{R}, \quad t \in \mathbb{R}.$$

When we apply the boundary conditions we get the equations

$$\varphi(0) = a = \varphi_0(0) + c_1, \quad \text{dvs.} \quad c_1 = a - \varphi_0(0),$$

and

$$\varphi(1) = b = \varphi_0(1) + c_1 e^2 \cos 1 + c_2 e^2 \sin 1.$$

Now,  $e^2 \sin 1 \neq 0$ , so we get

$$c_2 = \frac{1}{e^2 \sin 1} \{b - \varphi_0(1) - \{a - \varphi_0(0)\} e^2 \cos 1\},$$

and both  $c_1$  and  $c_2$  are uniquely determined by the conditions, and the claim is proved.

**Example 1.22** Consider the differential equation

$$\frac{d^2x}{dt^2} - 4 \frac{dx}{dt} + 5x = \cos t, \quad t \in \mathbb{R}.$$

Let  $a$  and  $b$  be two real numbers. How many solutions  $x = \varphi(t)$  of the differential equation satisfy  $\varphi(0) = a$  and  $\varphi(2\pi) = b$ ?

- A.** Linear inhomogeneous differential equation of second order and of constant coefficients.
- D.** Start by finding the roots of the characteristic polynomial, and find the complete solution of the homogeneous equation. Since  $\cos t = \operatorname{Re} e^{it}$ , we first guess (in a complex form) of a particular solution of the form  $x = c \cdot e^{it}$ . Finally, we apply the boundary conditions on the complete solution and analyze.
- I.** The characteristic polynomial  $R^2 - 4R + 5$  has the simple roots  $R = 2 \pm i$ , hence the homogeneous equation has the complete solution

$$c_1 e^{2t} \cos t + c_2 e^{2t} \sin t.$$

If we put  $x = c \cdot e^{it}$  into the left hand side of the equation we get

$$\frac{d^2x}{dt^2} - 4 \frac{dx}{dt} + 5x = c(-1 - 4i + 5)e^{it} = 4c(1 - i)e^{it},$$

which is equal to  $e^{it}$  for  $c = \frac{1}{4} \cdot \frac{1}{1 - i} = \frac{1}{8}(1 + i)$ . Thus, a particular solution is

$$\operatorname{Re} \left\{ \frac{1}{8}(1 + i)e^{it} \right\} = \frac{1}{8} \cos t - \frac{1}{8} \sin t.$$

The complete solution is

$$\varphi(t) = \frac{1}{8} \cos t - \frac{1}{8} \sin t + c_1 e^{2t} \cos t + c_2 e^{2t} \sin t.$$

From the given boundary value condition follows that

$$\varphi(0) = a = \frac{1}{8} + c_1, \quad \varphi(2\pi) = b = \frac{1}{8} + c_1 e^{4\pi}.$$

This gives

$$c_1 = a - \frac{1}{8} \quad \text{og} \quad c_1 = e^{-4\pi} \left( b - \frac{1}{8} \right).$$

Here we have two possibilities:

- 1) If  $a - \frac{1}{8} \neq e^{-4\pi} \left( b - \frac{1}{8} \right)$ , i.e.

$$e^{4\pi} a \neq b + \frac{1}{8} \{e^{4\pi} - 1\},$$

then there is no solution.



2) If instead  $e^{4\pi}a = b + \frac{1}{8}\{e^{4\pi} - 1\}$ , then

$$c_1 = a - \frac{1}{8} \left( = e^{-4\pi} \left( b - \frac{1}{8} \right) \right),$$

and we can choose  $c_2$  arbitrarily, and we conclude that we have infinitely many solutions.

**Example 1.23** Find the complete solution of the differential equation

$$\frac{d^2x}{dt^2} + 4 \frac{dx}{dt} + 4x = \sin 2t, \quad t \in \mathbb{R}.$$

**A.** Linear inhomogeneous differential equation of second order and of constant coefficients.

**D.** The characteristic polynomial  $R^2 + 4R + 4 = (R + 2)^2$  has the double root  $R = -2$ , hence the complete solution of the corresponding homogeneous equation is

$$c_1 e^{-2t} + c_2 t e^{-2t}, \quad c_1, c_2 \in \mathbb{R}, \quad t \in \mathbb{R}.$$

If we put  $x = \alpha e^{2it}$  into the left hand side of the equation, then

$$\alpha \{(2i)^2 + 4 \cdot 2i + 4\} e^{2it} = \alpha \cdot 8i \cdot e^{2it},$$

which is equal to  $e^{2it}$  for  $\alpha = -\frac{i}{8}$ . A particular solution of the original equation is

$$\operatorname{Im} \left\{ -\frac{i}{8} e^{2it} \right\} = -\frac{1}{8} \cos 2t.$$

The complete solution is

$$x = -\frac{1}{8} \cos 2t + c_1 e^{-2t} + c_2 t e^{-2t}, \quad c_1, c_2 \in \mathbb{R}, \quad t \in \mathbb{R}.$$

ALTERNATIVELY we may guess on a real solution as a linear combination of  $\cos 2t$  and  $\sin 2t$ . If so, then

$$\begin{array}{ll} x &= a \cos 2t + b \sin 2t, & 4x &= 4a \cos 2t + 4b \sin 2t, \\ \frac{dx}{dt} &= 2b \cos 2t - 2a \sin 2t, & 4 \frac{dx}{dt} &= 8b \cos 2t - 8a \sin 2t, \\ \frac{d^2x}{dt^2} &= -4a \cos 2t - 4b \sin 2t, & \frac{d^2x}{dt^2} &= -4a \cos 2t - 4b \sin 2t. \end{array}$$

It follows from the right hand column by an addition that

$$\frac{d^2x}{dt^2} + 4 \frac{dx}{dt} + 4x = 8b \cos 2t - 8a \sin 2t.$$

This is equal to  $\sin 2t$ , if  $a = -\frac{1}{8}$  and  $b = 0$ , thus a particular solution is  $-\frac{1}{8} \cos 2t$ .

The complete solution is

$$x = -\frac{1}{8} \cos 2t + c_1 e^{-2t} + c_2 t e^{-2t}, \quad c_1, c_2 \in \mathbb{R}, \quad t \in \mathbb{R}.$$

**Example 1.24** Given the differential equation

$$\frac{d^2x}{dt^2} + 2\frac{dx}{dt} + x = \sin^2 t, \quad t \in \mathbb{R}.$$

1) Prove that this differential equation does not have a solution of the form

$$x(t) = A \cdot \cos^2 t + B \cdot \sin^2 t, \quad t \in \mathbb{R},$$

where  $A$  and  $B$  are real constants.

2) Then find by a better guess a solution of the differential equation.

**A.** Linear inhomogeneous differential equation of second order and of constant coefficients.

**D.** Find the roots of the characteristic polynomial. Insert the function above and show that it cannot be a solution. Then re-write  $\sin^2 t$  by a trigonometric formula and find a better guess.

**I.** The characteristic polynomial  $R^2 + 2R + 1 = (R + 1)^2$  has the double root  $R = -1$ , so the homogeneous equation has the complete solution

$$c_1 e^{-t} + c_2 t e^{-t}, \quad c_1, c_2 \in \mathbb{R}, \quad t \in \mathbb{R}.$$



**#1**  
in eco-friendly  
attitude

**STUDY AT  
LINKÖPING UNIVERSITY, SWEDEN**  
RANKED AMONG TOP 50 UNIVERSITIES UNDER 50

Interested in Strategy and Management in International Organisations? Kick-start your career with a master's degree from Linköping University, Sweden.

→ **Click here!**

 **Linköping University**



1) If we put  $x(t) = A \sin^2 t + B \cos^2 t$ , then

$$\frac{dx}{dt} = 2(A - B) \sin t \cos t, \quad \frac{d^2x}{dt^2} = 2(A - B) \{\cos^2 t - \sin^2 t\},$$

which by insertion

$$\begin{aligned} \frac{d^2x}{dt^2} + 2 \frac{dx}{dt} + x &= 2(A - B) \{\cos^2 t - \sin^2 t\} + 4(A - B) \sin t \cos t + A \sin^2 t + B \cos^2 t \\ &= (2B - A) \sin^2 t + 4(A - B) \sin t \cos t + (2A - B) \cos^2 t. \end{aligned}$$

If this should be equal to  $\sin^2 t$ , then we must have

$$2B - A = 1, \quad A - B = 0, \quad 2A - B = 0,$$

thus  $A = B = 2B$ , or  $A = B = 0$ , while also  $2B - A = 1$ . These two conditions cannot be fulfilled at the same time, so the guess is wrong.

2) Since  $\sin^2 t = \frac{1}{2} - \frac{1}{2} \cos 2t$ , we try to put

$$x(t) = \frac{1}{2} + \alpha e^{2it}.$$

Then

$$\begin{aligned} \frac{d^2x}{dt^2} + 2 \frac{dx}{dt} + x &= \frac{1}{2} + \alpha \{(2i)^2 + 2 \cdot 2i + 1\} e^{2it} \\ &= \frac{1}{2} + \alpha \{4i - 3\} e^{2it}, \end{aligned}$$

which is equal to  $\frac{1}{2} - \frac{1}{2} e^{2it}$  for  $\alpha \{4i - 3\} = \frac{1}{2}$ , i.e.

$$\alpha = \frac{\frac{1}{2}}{3 - 4i} = \frac{1}{50} (3 + 4i).$$

Hence a solution of the differential equation is given by

$$\operatorname{Re} \left\{ \frac{1}{50} (3 + 4i) e^{2it} \right\} = \frac{1}{50} \{3 \cos 2t - 4 \sin 2t\}.$$

The complete solution is

$$x(t) = \frac{1}{50} \{3 \cos 2t - 4 \sin 2t\} + c_1 e^{-t} + c_2 t e^{-t}, \quad t \in \mathbb{R},$$

where  $c_1, c_2 \in \mathbb{R}$  are arbitrary constants.

**Example 1.25** Find the complete solution of the differential equation

$$\frac{d^3x}{dt^3} + 3 \frac{d^2x}{dt^2} + 4 \frac{dx}{dt} - 8x = 6e^t \cos 2t, \quad t \in \mathbb{R}.$$

- A. Linear inhomogeneous differential equation of third order and of constant coefficients.  
 D. Find the roots of the characteristic polynomial; guess a particular solution.  
 I. It follows immediately from the characteristic polynomial  $R^3 + 3R^2 + 4R - 8$  has the root 1, so we get the factorization

$$R^3 + 3R^2 + 4R - 8 = (R - 1)(R^2 + 4R + 8) = (R - 1)\{(R + 2)^2 + 2^2\}.$$

The simple roots are  $R = 1$  and  $R = -2 \pm 2i$ , and the complete solution of the homogeneous equation is

$$c_1 e^t + c_2 e^{-2t} \cos 2t + c_3 e^{-2t} \sin 2t, \quad c_1, c_2, c_3 \in \mathbb{R}, \quad t \in \mathbb{R}.$$

Since  $6e^t \cos 2t = \operatorname{Re}\{6e^{(1+2i)t}\}$ , we guess a solution of the form  $x = a e^{(1+2i)t}$  of the equation with  $6e^{(1+2i)t}$  on the right hand side.

By insertion we get

$$\begin{aligned} \frac{d^3x}{dt^3} + 3 \frac{d^2x}{dt^2} + 4 \frac{dx}{dt} - 8x &= a e^{(1+2i)t} \{(1+2i)^3 + 3(1+2i)^2 + 4(1+2i) - 8\} \\ &= a e^{(1+2i)t} \{(1+2i)^2(4+2i) + 4(-1+2i)\} \\ &= a e^{(1+2i)t} \{(-3+4i)(4+2i) - 4 + 8i\} \\ &= a e^{(1+2i)t} \{-12 - 8 - 4 - 6i + 16i + 8i\} \\ &= a(-24 + 18i)e^{(1+2i)t}, \end{aligned}$$

which is equal to  $6e^{(1+2i)t}$  for

$$a = \frac{6}{-24 + 18i} = \frac{1}{-4 + 3i} = \frac{-4 - 3i}{25} = -\frac{4 + 3i}{25}.$$

Hence we get the solution

$$\operatorname{Re} \left\{ -\frac{4 + 3i}{25} e^{(1+2i)t} \right\} = -\frac{1}{25} e^t \{4 \cos 2t - 3 \sin 2t\}.$$

Thus the complete solution is

$$-\frac{4}{25} e^t \cos 2t + \frac{3}{25} e^t \sin 2t + c_1 e^t + c_2 e^{-2t} \cos 2t + c_3 e^{-2t} \sin 2t,$$

where  $t \in \mathbb{R}$ , and where  $c_1, c_2, c_3 \in \mathbb{R}$  are arbitrary constants.

ALTERNATIVELY, guess a real linear combination of  $e^t \cos 2t$  and  $e^t \sin 2t$ . Then we obtain

$$\begin{aligned} x &= a e^t \cos 2t + b e^t \sin 2t, \\ \frac{dx}{dt} &= (a + 2b)e^t \cos 2t + (-2a + b)e^t \sin 2t, \\ \frac{d^2x}{dt^2} &= \{(a + 2b) + 2(-2a + b)\}e^t \cos 2t \\ &\quad + \{-2(a + 2b) + (-2a + b)\}e^t \sin 2t \\ &= (-3a + 4b)e^t \cos 2t + (-4a - 3b)e^t \sin 2t, \\ \frac{d^3x}{dt^3} &= \{(-3a + 4b) + 2(-4a - 3b)\}e^t \cos 2t \\ &\quad + \{-2(-3a + 4b) + (-4a - 3b)\}e^t \sin 2t \\ &= (-11a - 2b)e^t \cos 2t + (2a - 11b)e^t \sin 2t. \end{aligned}$$

Then by insertion,

$$\begin{aligned} \frac{d^3x}{dt^3} + 3 \frac{d^2x}{dt^2} + 4 \frac{dx}{dt} - 8x &= (-11a - 2b)e^t \cos 2t + (2a - 11b)e^t \sin 2t \\ &\quad + 3(-3a + 4b)e^t \cos 2t + 3(-4a - 3b)e^t \sin 2t \\ &\quad + 4(a + 2b)e^t \cos 2t + 4(-2a + b)e^t \sin 2t \\ &\quad - 8a e^t \cos 2t - 8b e^t \sin 2t \\ &= \{(-11 - 9 + 4 - 8)a + (-2 + 12 + 8)b\}e^t \cos 2t \\ &\quad + \{(2 - 12 - 8)a + (-11 - 9 + 4 - 8)b\}e^t \sin 2t \\ &= (-24a + 18b)e^t \cos 2t + (-18a - 24b)e^t \sin 2t. \end{aligned}$$

This is equal to  $6e^t \cos 2t$ , if

$$\begin{cases} -24a + 18b = 6, \\ -18a - 24b = 0, \end{cases} \quad \text{dvs.} \quad \begin{cases} -4a + 3b = 1, \\ 3a + 4b = 0, \end{cases}$$

so  $a = -\frac{4}{25}$  and  $b = \frac{3}{25}$ . A particular solution is therefore

$$x = -\frac{4}{25} e^t \cos 2t + \frac{3}{25} e^t \sin 2t,$$

and the complete solution is

$$\begin{aligned} x &= -\frac{4}{25} e^t \cos 2t + \frac{3}{25} e^t \sin 2t \\ &\quad + c_1 e^t + c_2 e^{-2t} \cos 2t + c_3 e^{-2t} \sin 2t, \end{aligned}$$

where  $t \in \mathbb{R}$ , and  $c_1, c_2, c_3 \in \mathbb{R}$  are arbitrary constants.

**Example 1.26** 1) Show by means of Euler's formulæ that

$$\sin^3 t = \frac{3}{4} \sin t - \frac{1}{4} \sin 3t.$$

2) Find the complete solution of the differential equation

$$\frac{d^2x}{dt^2} - 6 \frac{dx}{dt} + 9x = 3 \sin t - 4 \sin^3 t, \quad t \in \mathbb{R}.$$

- A.** Euler's formulæ; linear inhomogeneous differential equation of second order and of constant coefficients.
- D.** Insert into Euler's formulæ; find the roots of the characteristic polynomial. Finally, apply (1) to guess a solution of the inhomogeneous equation in (2).



"I studied English for 16 years but...  
...I finally learned to speak it in just six lessons"

Jane, Chinese architect

ENGLISH OUT THERE

Click to hear me talking before and after my unique course download



I. 1) We get by means of Euler's formulæ,

$$\begin{aligned}\sin^3 t &= \left\{ \frac{1}{2i} (e^{it} - e^{-it}) \right\}^3 = \frac{1}{8i^3} \{ e^{3it} - 3e^{it} + 3e^{-it} - e^{-3it} \} \\ &= \frac{1}{4} \left\{ -\frac{1}{2i} (e^{3it} - e^{-3it}) + 3 \cdot \frac{1}{2i} (e^{it} - e^{-it}) \right\} \\ &= -\frac{1}{4} \sin 3t + \frac{3}{4} \sin t.\end{aligned}$$

The characteristic polynomial  $R^2 - 6R + 9 = (R - 3)^2$  has the double root  $R = 3$ , so the corresponding homogeneous equation has the complete solution

$$c_1 e^{3t} + c_2 t e^{3t}, \quad c_1, c_2 \in \mathbb{R}, \quad t \in \mathbb{R}.$$

According to (1) the right hand side of the equation is equal to  $\sin 3t$ . Now, if we put  $x = \alpha \cdot e^{3it}$  into the left hand side of the equation, we get

$$\alpha \cdot (3i - 3)^2 e^{3it} = -18i\alpha \cdot e^{3it},$$

which is equal to  $e^{3it}$  for  $\alpha = -\frac{1}{18i} = \frac{i}{18}$ . Then a particular solution is

$$\operatorname{Im} \left\{ \frac{i}{18} e^{3it} \right\} = \frac{1}{18} \cos 3t,$$

which is easily checked. The complete solution is then

$$x = \frac{1}{18} \cos 3t + c_1 e^{3t} + c_2 t e^{3t}, \quad c_1, c_2 \in \mathbb{R}, \quad t \in \mathbb{R}.$$

**Example 1.27** Find the complete solution of the differential equation

$$\frac{d^2 x}{dt^2} - 2 \frac{dx}{dt} + 17x = 2 \cos 3t, \quad t \in \mathbb{R}.$$

A. Linear inhomogeneous differential equation of second order and of constant coefficients.

D. The characteristic polynomial

$$R^2 - 2R + 17 = (R - 1)^2 + 16$$

has the simple roots  $R = 1 \pm 4i$ , thus the complete solution of the homogeneous equation is

$$x = c_1 e^t \cos 4t + c_2 e^t \sin 4t, \quad c_1, c_2 \in \mathbb{R}, \quad t \in \mathbb{R}.$$

If we put  $x = \alpha e^{3it}$  into the left hand side of the equation, we get

$$\frac{d^2 x}{dt^2} - 2 \frac{dx}{dt} + 17x = \alpha e^{3it} (-9 - 6i + 17) = \alpha (8 - 6i) e^{3it}.$$

This is equal to  $2e^{3it}$  for

$$\alpha = \frac{2}{8 - 6i} = \frac{1}{4 - 3i} = \frac{4 + 3i}{25}.$$

Thus a particular solution is given by

$$x = \operatorname{Re} \left\{ \frac{4+3i}{25} e^{3it} \right\} = \frac{4}{25} \cos 3t - \frac{3}{25} \sin 3t.$$

The complete solution is

$$x = \frac{4}{25} \cos 3t - \frac{3}{25} \sin 3t + c_1 e^t \cos 4t + c_2 e^t \sin 4t, \quad t \in \mathbb{R},$$

where  $c_1, c_2 \in \mathbb{R}$  are arbitrary constants.

**Example 1.28** Find the complete solution of the differential equation

$$\frac{d^2x}{dt^2} + 4 \frac{dx}{dt} + 4x = \cosh t, \quad t \in \mathbb{R}.$$

- A.** Linear inhomogeneous differential equation of second order and of constant coefficients.  
**D.** Find the roots of the characteristic polynomial; guess a particular solution.  
**I.** The characteristic polynomial  $R^2 + 4R + 4$  has the double root  $R = -2$ , so the corresponding homogeneous equation has the complete solution

$$c_1 e^{-2t} + c_2 t e^{-2t}, \quad c_1, c_2 \in \mathbb{R}, \quad t \in \mathbb{R}.$$

If we put  $x = \alpha \cosh t + \beta \sinh t$  into the left hand side of the equation, we get

$$\frac{d^2x}{dt^2} + 4 \frac{dx}{dt} + 4x = (5\alpha + 4\beta) \cosh t + (4\alpha + 5\beta) \sinh t.$$

This is equal to  $\cosh t$ , if and only if

$$4\alpha + 5\beta = 0 \quad \text{and} \quad 5\alpha + 4\beta = 1,$$

so  $\alpha = \frac{5}{9}$  and  $\beta = -\frac{4}{9}$ . Thus the complete solution is

$$\begin{aligned} x &= \frac{5}{9} \cosh t - \frac{4}{9} \sinh t + c_1 e^{-2t} + c_2 t e^{-2t} \\ &= \frac{1}{18} e^t + \frac{1}{2} e^{-t} + c_1 e^{-2t} + c_2 t e^{-2t}, \quad t \in \mathbb{R}, \end{aligned}$$

where  $c_1, c_2 \in \mathbb{R}$  are arbitrary constants.



**Example 1.29** Consider the differential equation

$$\frac{d^2x}{dt^2} + a_1 \frac{dx}{dt} + a_0 x = q(t), \quad t \in \mathbb{R}.$$

Is the following theorem correct or wrong:

- When  $t_0, t_1, a$  and  $b$  are given real numbers, where  $t_0 \neq t_1$ , then there is one and only one solution  $x = \varphi(t)$ ,  $t \in \mathbb{R}$ , such that  $\varphi(t_0) = a$  and  $\varphi(t_1) = b$ .

A. Boundary value problem.

D. Bet on that this is not a correct statement and construct a counterexample.

I. The equation

$$\frac{d^2x}{dt^2} + x = 0,$$

has the characteristic polynomial  $R^2 + 1$ , and thus the complete solution

$$x = c_1 \sin t + c_2 \cos t, \quad c_1, c_2 \in \mathbb{R}, \quad t \in \mathbb{R}.$$

By choosing  $t_0 = 0$  and  $t_1 = \pi$ , and  $a = b = 0$ , we get  $c_2 = 0$ , while  $c_1$  can be chosen arbitrarily, i.e. the complete solution of the differential equation is

$$\varphi_c(t) = c \cdot \sin t, \quad c \in \mathbb{R},$$

where

$$\varphi_c(0) = 0 \quad \text{and} \quad \varphi_c(\pi) = 0.$$

Thus, we do not have uniqueness, and the claim is in general wrong. There may, however, exist special examples in which the claim is right.

**Example 1.30** Which kind of function should one guess on as a solution of the differential equation

$$\frac{d^2x}{dt^2} + a \frac{dx}{dt} + bx = e^{st}, \quad t \in \mathbb{R},$$

where  $s$  is a constant, independent of  $t$ ? Under what circumstances will such a guess fail, and what should one guess instead? What if this second guess also fails?

A. Particular solution by the method of guessing.

D. Insert  $x = c e^{st}$  and analyze.

I. The characteristic polynomial is  $R^2 + aR + b$ .

1) If  $s$  is not a root of the characteristic polynomial, we guess on  $c \cdot e^{st}$ . Then by insertion

$$\frac{d^2x}{dt^2} + a \frac{dx}{dt} + bx = c(s^2 + as + b)e^{st}.$$

The assumption assures that  $s^2 + as + b \neq 0$ , hence this is equal to  $e^{st}$  for  $c = \frac{1}{s^2 + as + b}$ , and a particular solution is in this case given by

$$\frac{1}{s^2 + as + b} e^{st}.$$

- 2) If  $s$  is a root of the characteristic polynomial, we of course get zero by insertion. We must instead guess on

$$x = ct e^{st} \quad \text{where} \quad \frac{dx}{dt} = ce^{st} + cste^{st},$$

and

$$\frac{d^2x}{dt^2} = 2cse^{st} + cs^2te^{st}.$$

We get by insertion

$$\frac{d^2x}{dt^2} + a \frac{dx}{dt} + bx = 0 + ace^{st} + 2sce^{st} = c(a + 2s)e^{st}.$$

If  $s$  is a simple root of the characteristic polynomial, i.e.  $2s + a \neq 0$ , then we get the solution

$$x = \frac{1}{2s + a} t e^{st}.$$

Excellent Economics and Business programmes at:



**university of  
 groningen**



**“The perfect start  
 of a successful,  
 international career.”**

**CLICK HERE**  
 to discover why both socially  
 and academically the University  
 of Groningen is one of the best  
 places for a student to be

[www.rug.nl/feb/education](http://www.rug.nl/feb/education)



- 3) If  $s$  is a double root of the characteristic polynomial, then also  $2s + a = 0$ , because the double root necessarily is  $-\frac{a}{2}$ . In that case we guess instead on  $x = ct^2e^{st}$ , and we get

$$\frac{dx}{dt} = cst^2e^{st} + 2cte^{st}$$

and

$$\frac{d^2x}{dt^2} = cs^2t^2e^{st} + 4cste^{st} + 2ce^{st},$$

hence by insertion,  $2ce^{st} = e^{st}$  for  $c = \frac{1}{2}$ , and a particular solution is

$$x = \frac{1}{2}t^2e^{st}.$$

**Example 1.31** Find the complete solution of the differential equation

$$\frac{d^2x}{dt^2} + 3\frac{dx}{dt} + 3x = t^2 + 4t + 3, \quad t \in \mathbb{R}.$$

- A.** Linear differential equation of second order and of constant coefficients.  
**D.** Find the roots of the characteristic polynomial. Then guess systematically on a particular solution.  
**I.** The characteristic polynomial  $R^2 + 3R + 3$  has the simple roots

$$R = \frac{1}{2}\{-3 \pm \sqrt{9 - 4 \cdot 4 \cdot 3}\} = \frac{1}{2}\{-3 \pm i\sqrt{3}\},$$

so the complete solution of the homogeneous equation is

$$c_1 \exp\left(-\frac{3}{2}t\right) \cos\left(\frac{\sqrt{3}}{2}t\right) + c_2 \exp\left(-\frac{3}{2}t\right) \sin\left(\frac{\sqrt{3}}{2}t\right).$$

Then we guess on  $x = at^2 + bt + c$  as a particular solution. By insertion into the left hand side of the equation we get

$$\begin{aligned} \frac{d^2x}{dt^2} + 3\frac{dx}{dt} + 3x &= 2a + 3(2at + b) + 3(at^2 + bt + c) \\ &= 3at^2 + (6a + 3b)t + (2a + 3b + 3c). \end{aligned}$$

This is equal to  $t^2 + 4t + 3$ , when

$$3a = 1, \quad 6a + 3b = 4 \quad \text{and} \quad 2a + 3b + 3c = 3,$$

so  $a = \frac{1}{3}$ ,  $b = \frac{2}{3}$  and  $c = \frac{1}{9}$ . The complete solution is

$$\begin{aligned} x &= \frac{1}{3}t^2 + \frac{2}{3}t + \frac{1}{9} + c_1 \exp\left(-\frac{3}{2}t\right) \cos\left(\frac{\sqrt{3}}{2}t\right) \\ &\quad + c_2 \exp\left(-\frac{3}{2}t\right) \sin\left(\frac{\sqrt{3}}{2}t\right), \quad t \in \mathbb{R}, \quad c_1, c_2 \in \mathbb{R}. \end{aligned}$$

**Example 1.32** Consider the differential equation

$$(3) \quad \frac{d^2x}{dt^2} + a_1 \frac{dx}{dt} + a_0x = 0, \quad t \in \mathbb{R},$$

where the characteristic equation  $R^2 + a_1R + a_0 = 0$  has two complex roots  $R = \alpha \pm i\beta$ ,  $\beta \neq 0$  with the corresponding solutions

$$\varphi_1(t) = e^{\alpha t} \cos \beta t, \quad \varphi_2(t) = e^{\alpha t} \sin \beta t.$$

Prove by applying the existence and uniqueness theorem that the functions

$$x = c_1\varphi_1(t) + c_2\varphi_2(t), \quad t \in \mathbb{R}, \quad c_1, c_2 \in \mathbb{R},$$

form the complete solution of (3).

- A.** Linear differential equation of second order and of constant coefficients. A theoretical application of the existence and uniqueness theorem.
- D.** Start by recalling the existence and uniqueness theorem.
- I.** For any given vector  $(t_0, x_0, v_0)$  there exists according to the existence and uniqueness theorem one and only one solution  $x = \varphi(t)$ , such that

$$\varphi(t_0) = x_0 \quad \text{and} \quad \varphi'(t_0) = v_0.$$

In the given example we shall prove that one always can find  $c_1$  and  $c_2$ , such that this is fulfilled.

If

$$\varphi(t) = c_1 e^{\alpha t} \cos \beta t + c_2 e^{\alpha t} \sin \beta t,$$

then

$$\begin{aligned} \varphi'(t) &= c_1 \{ \alpha e^{\alpha t} \cos \beta t - \beta e^{\alpha t} \sin \beta t \} \\ &\quad + c_2 \{ \alpha e^{\alpha t} \sin \beta t + \beta e^{\alpha t} \cos \beta t \}. \end{aligned}$$

Since

$$\begin{aligned} &\left| \begin{array}{cc} e^{\alpha t} \cos \beta t & e^{\alpha t} \sin \beta t \\ \alpha e^{\alpha t} \cos \beta t - \beta e^{\alpha t} \sin \beta t & \alpha e^{\alpha t} \sin \beta t + \beta e^{\alpha t} \cos \beta t \end{array} \right| \\ &= \left| \begin{array}{cc} e^{\alpha t} \cos \beta t & e^{\alpha t} \sin \beta t \\ -\beta e^{\alpha t} \sin \beta t & \beta e^{\alpha t} \cos \beta t \end{array} \right| = e^{2\alpha t} \beta (\cos^2 \beta t + \sin^2 \beta t) \\ &= \beta e^{2\alpha t} \neq 0, \end{aligned}$$

we can always solve the corresponding system of equations in  $c_1$  and  $c_2$ , when  $\varphi(t_0) = x_0$  and  $\varphi'(t_0) = v_0$  and  $t = t_0$  are given, hence the solution is uniquely determined.

**Example 1.33** Consider the differential equation

$$(4) \quad \frac{d^2x}{dt^2} + a_1 \frac{dx}{dt} + a_0x = 0, \quad t \in \mathbb{R},$$

where the characteristic equation  $R^2 + a_1R + a_0 = 0$  has the double root  $R = r$ . Thus, at least we have the solution

$$\varphi_1(t) = e^{rt}.$$

1) First prove that  $r = -\frac{1}{2}a_1$ .

2) Then prove by insertion that

$$\varphi_2(t) = te^{rt}$$

is a solution of (4).

3) Prove by an application of the existence and uniqueness theorem that the functions

$$x = c_1\varphi_1(t) + c_2\varphi_2(t), \quad t \in \mathbb{R}, \quad c_1, c_2 \in \mathbb{R},$$

are the complete solution of (4).

**A.** Linear differential equation of second order and of constant coefficients, where the characteristic polynomial has a double root.

**D.** Write the characteristic polynomial in two ways and compare.

Insert  $\varphi_2(t)$  and apply the existence and uniqueness theorem.

**I.** 1) It follows from

$$R^2 + a_1R + a_0 = (R - r)^2 = R^2 - 2rR + r^2,$$

that  $a_1 = -2r$  and  $a_0 = r^2$ , hence

$$r = -\frac{1}{2}a_1.$$

We can now write

$$(5) \quad \frac{d^2x}{dt^2} - 2r \frac{dx}{dt} + r^2x = 0, \quad t \in \mathbb{R}.$$

2) If we put  $\varphi_2(t) = te^{rt}$ , then

$$\begin{aligned} \varphi_2'(t) &= rt e^{rt} + e^{rt}, \\ \varphi_2''(t) &= r^2t e^{rt} + 2r e^{rt}, \end{aligned}$$

hence

$$\begin{aligned} \varphi_2''(t) - 2r \varphi_2'(t) + r^2 \varphi_2(t) \\ = r^2t e^{rt} + 2r e^{rt} - 2r^2t e^{rt} - 2r e^{rt} + r^2t e^{rt} = 0, \end{aligned}$$

and we have proved that  $\varphi_2(t) = te^{rt}$  is a solution.

3) Then let

$$x = \varphi(t) = c_1\varphi_1(t) + c_2\varphi_2(t) = c_1e^{rt} + c_2te^{rt}.$$

We shall prove that if  $\varphi(t_0) = x_0$  and  $\varphi'(t_0) = v_0$ , then  $c_1$  and  $c_2$  are unique, and the rest follows from the existence and uniqueness theorem.

It follows from

$$\varphi'(t) = c_1r e^{rt} + c_1(1 + rt)e^{rt},$$

that

$$\begin{cases} c_1e^{rt_0} + c_2t_0e^{rt_0} = \varphi_0(t_0) = x_0, \\ c_1r e^{rt_0} + c_2(1 + rt_0)e^{rt_0} = \varphi'_0(t_0) = v_0, \end{cases}$$

i.e.

$$\begin{cases} c_1 + t_0c_2 & = x_0e^{-rt_0}, \\ rc_1 + (1 + rt_0)c_2 & = v_0e^{-rt_0}. \end{cases}$$

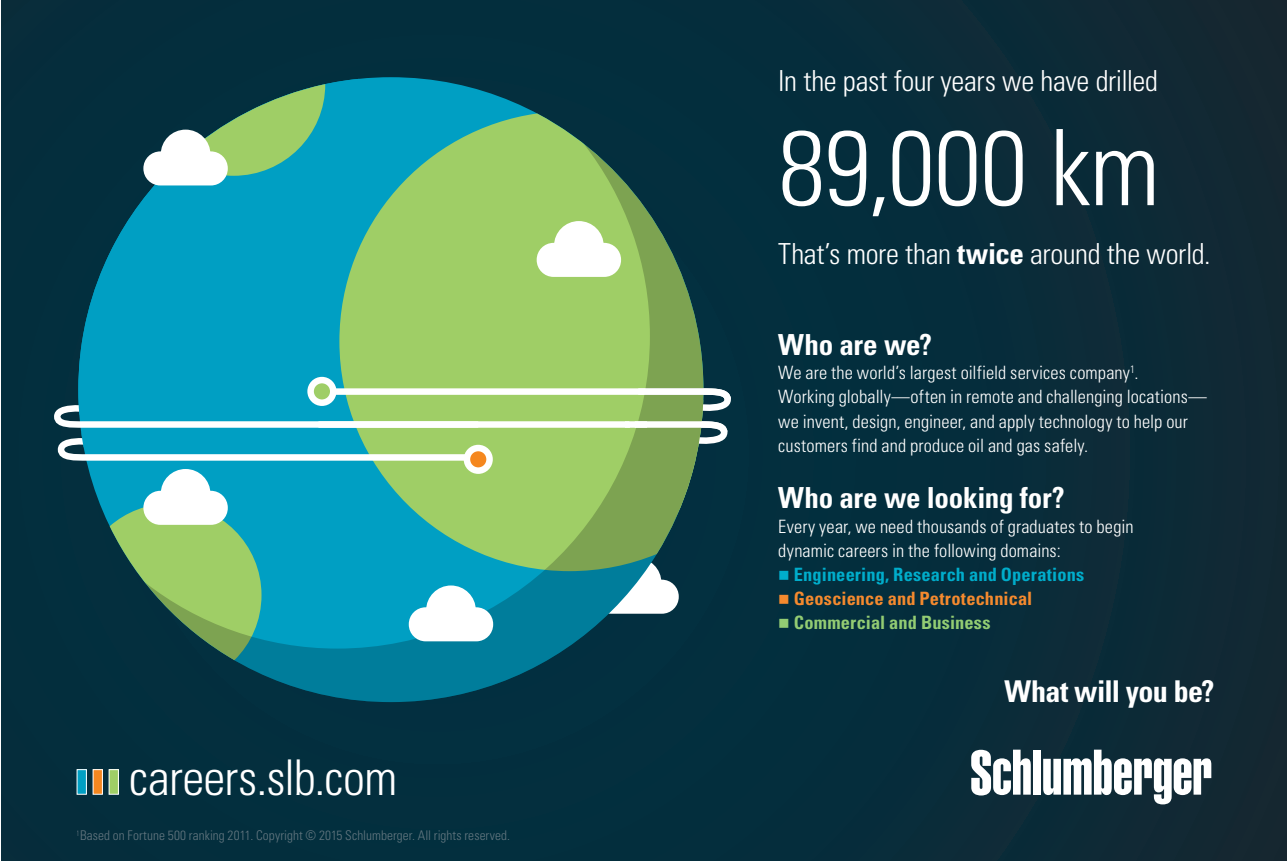

In the past four years we have drilled

# 89,000 km

That's more than **twice** around the world.

**Who are we?**  
We are the world's largest oilfield services company<sup>1</sup>. Working globally—often in remote and challenging locations—we invent, design, engineer, and apply technology to help our customers find and produce oil and gas safely.

**Who are we looking for?**  
Every year, we need thousands of graduates to begin dynamic careers in the following domains:

- **Engineering, Research and Operations**
- **Geoscience and Petrotechnical**
- **Commercial and Business**

**What will you be?**

**Schlumberger**

[careers.slb.com](http://careers.slb.com)

<sup>1</sup>Based on Fortune 500 ranking 2011. Copyright © 2015 Schlumberger. All rights reserved.

This linear system of equations has a unique solution, if and only if the corresponding determinant is different from 0. The determinant is

$$\begin{vmatrix} 1 & t_0 \\ r & 1 + rt_0 \end{vmatrix} = 1 + rt_0 - rt_0 = 1 \neq 0,$$

and we see that the condition is fulfilled.

REMARK 1. Notice that

$$\begin{aligned} c_1 &= (1 + rt_0)x_0 e^{-rt_0} - rt_0 v_0 e^{-rt_0} \\ &= e^{-rt_0} \{x_0 + rt_0(x_0 - v_0)\}, \\ c_2 &= v_0 e^{-rt_0} - rx_0 e^{-rt_0} \\ &= e^{-rt_0} \{v_0 - rx_0\}. \quad \diamond \end{aligned}$$

REMARK 2. “*Vielgeschrei und wenig Wolle!*”, sagte der Teufel, als er seine Sau beschor! An ALTERNATIVE method is the following:

The differential equation

$$\frac{d^2 y}{dt^2} = 0$$

can be solved by two successive integrations, so the complete solution is

$$y = c_1 + c_2 t, \quad \text{where } c_1, c_2 \in \mathbb{R} \text{ are arbitrary constants.}$$

If we put  $y = x e^{-rt}$ , then it follows that the equation

$$\begin{aligned} (6) \quad \frac{d^2 y}{dt^2} &= \frac{d^2 x e^{-rt}}{dt^2} = \frac{d}{dt} \left\{ \frac{dx}{dt} \cdot e^{-rt} - r x e^{-rt} \right\} \\ &= e^{-rt} \left\{ \frac{d^2 x}{dt^2} - 2r \frac{dx}{dt} + r^2 x \right\} = 0, \end{aligned}$$

has the complete solution  $y = x e^{-rt} = c_1 + c_2 t$ , i.e.  $x = c_1 e^{rt} + c_2 t e^{rt}$ , using that  $e^{-rt} \neq 0$  for all  $t \in \mathbb{R}$ . This means that the differential equation

$$\frac{d^2 x}{dt^2} - 2r \frac{dx}{dt} + r^2 x = 0,$$

has the complete solution

$$x = c_1 e^{rt} + c_2 t e^{rt}, \quad t \in \mathbb{R}, \quad c_1, c_2 \in \mathbb{R}.$$

This proof applies the more basic fact that integrals of continuous functions are uniquely determined apart from an arbitrary constant.  $\diamond$

**Example 1.34** 1) Prove that the differential equation

$$(7) \quad \frac{d^2x}{dt^2} - 3 \frac{dx}{dt} + 2x = e^t, \quad t \in \mathbb{R},$$

does not have a solution of the form  $x = c \cdot e^t$ , and that (7) has a solution of the form  $x = c \cdot t e^t$ ,  $t \in \mathbb{R}$ .

2) Prove that the differential equation

$$(8) \quad \frac{d^2x}{dt^2} - 2 \frac{dx}{dt} + x = e^t, \quad t \in \mathbb{R},$$

does not have a solution of the form  $x = c \cdot e^t$  or of the form  $x = c \cdot t e^t$ , and that (8) has a solution of the form  $x = c \cdot t^2 e^t$ ,  $t \in \mathbb{R}$ .

3) Prove the following

THEOREM. Consider the differential equation

$$(9) \quad \frac{d^2x}{dt^2} + a_1 \frac{dx}{dt} + a_0 x = e^t, \quad t \in \mathbb{R},$$

and its corresponding characteristic equation

$$R^2 + a_1 R + a_0 = 0.$$

a) If  $R = 1$  is a root in the characteristic equation, then (9) does not have a solution of the form  $x = c \cdot e^t$ ,  $t \in \mathbb{R}$ .

b) If  $R = 1$  is a simple root in the characteristic equation, then (9) has a solution of the form  $x = c \cdot t e^t$ ,  $t \in \mathbb{R}$ .

c) If  $R = 1$  is a double root in the characteristic equation, then (9) has a solution of the form  $x = c \cdot t^2 e^t$ ,  $t \in \mathbb{R}$ .

**A.** Linear differential equation of second order and of constant coefficients with a guideline.

**D.** Insert the given functions into (1) and (2). Then, we generalize in (3).

**I.** 1) The characteristic equation

$$R^2 - 3R + 2 = (R - 1)(R - 2)$$

has the roots  $R = 1$  and  $R = 2$ , so the corresponding homogeneous equation has the complete solution

$$c_1 e^t + c_2 e^{2t}, \quad t \in \mathbb{R}, \quad c_1, c_2 \in \mathbb{R}.$$

In particular,  $c_1 e^t$  is mapped into 0 by the differential operator, so  $c \cdot e^t$  cannot be a particular solution.

If we choose  $x = c \cdot t e^t$ , then

$$\frac{dx}{dt} = c t e^t + c e^t \quad \text{og} \quad \frac{d^2x}{dt^2} = c t e^t + 2 c e^t.$$



By insertion into the left hand side of the equation we get

$$\begin{aligned}\frac{d^2x}{dt^2} - 3\frac{dx}{dt} + 2x &= \{cte^t + 2ce^t\} - 3\{cte^t + ce^t\} + 2cte^t \\ &= c(1 - 3 + 2)te^t + c(2 - 3)e^t = -ce^t,\end{aligned}$$

which is equal to  $e^t$  for  $c = -1$ , and  $x_0(t) = -te^t$  is a particular solution.

2) The characteristic polynomial

$$R^2 - 2R + 1 = (R - 1)^2$$

has the double root  $R = 1$ , thus the homogeneous equation has the complete solution

$$x = c_1e^t + c_2te^t, \quad t \in \mathbb{R}, \quad c_1, c_2 \in \mathbb{R}.$$

In particular,  $c_1e^t$  and  $c_2te^t$  are always mapped into 0 by this differential operator, and these functions are never solutions of the inhomogeneous equation.

If  $x = c \cdot t^2e^t$ , then

$$\frac{dx}{dt} = ct^2e^t + 2cte^t,$$

and

$$\frac{d^2x}{dt^2} = ct^2e^t + 4cte^t + 2ce^t.$$

We get by insertion into the left hand side of the equation

$$\begin{aligned}\frac{d^2x}{dt^2} - 2\frac{dx}{dt} + x &= (ct^2 + 4ct + 2c)e^t - 2(ct^2 + 2ct)e^t + ct^2e^t \\ &= c(1 - 2 + 1)t^2e^t + c(4 - 4)te^t + 2ce^t = 2ce^t.\end{aligned}$$

This is equal to  $e^t$  for  $c = \frac{1}{2}$ , hence a particular solution is given by

$$x = \frac{1}{2}t^2e^t.$$

3) a) If  $R = 1$  is a root of the characteristic equation, then  $c \cdot e^t$  is a solution of the corresponding homogeneous. Therefore, it never can be a solution of the inhomogeneous equation, if the right hand side is  $\neq 0$ .

b) If the characteristic polynomial is

$$R^2 + a_1R + a_0 = (R - 1)(R - a_0), \quad a_0 \neq 1,$$

then  $a_1 = -1 - a_0$ . If we put  $x = cte^t$ , then we get

$$\frac{dx}{dt} = ct e^t + ce^t, \quad \frac{d^2x}{dt^2} = ct e^t + 2ce^t.$$

Then by insertion into the left hand side of the equation

$$\begin{aligned}\frac{d^2x}{dt^2} + a_1\frac{dx}{dt} + a_0x &= \frac{d^2x}{dt^2} - (a_0 + 1)\frac{dx}{dt} + a_0x \\ &= c(t + 2)e^t - (a_0 + 1)c(t + 1)e^t + a_0cte^t \\ &= c\{1 - (a_0 + 1) + a_0\}te^t + c(2 - a_0 - 1)e^t = c(1 - a_0)e^t.\end{aligned}$$

Since  $a_0 \neq 1$ , this expression is equal to  $e^t$  for  $c = \frac{1}{1 - a_0}$ , hence a particular solution is given by

$$x = \frac{1}{1 - a_0} t e^t,$$

and the claim is proved.

c) If  $R = 1$  is a double root, then

$$\frac{d^2x}{dt^2} + a_1 \frac{dx}{dt} + a_0 x = \frac{d^2x}{dt^2} - 2 \frac{dx}{dt} + x = e^t.$$

We have already treated this equation in (2), so we get immediately the result.

## American online LIGS University

is currently enrolling in the  
Interactive Online **BBA, MBA, MSc,**  
**DBA and PhD** programs:

- ▶ enroll **by September 30th, 2014** and
- ▶ **save up to 16%** on the tuition!
- ▶ pay in 10 installments / 2 years
- ▶ Interactive **Online education**
- ▶ visit [www.ligsuniversity.com](http://www.ligsuniversity.com) to  
find out more!

**Note:** LIGS University is not accredited by any  
nationally recognized accrediting agency listed  
by the US Secretary of Education.  
More info [here](#).



Click on the ad to read more

**Example 1.35 (1)** Find the complete solution of the differential equation

$$\frac{d^2u}{d\theta^2} + u = K,$$

where  $(r, \theta)$  are the polar coordinates, and  $u = 1/r$ . Prove that  $r$  as a function of  $\theta$  is given by

$$(10) \quad r = \frac{1}{K + c_1 \cos \theta + c_2 \sin \theta}.$$

We shall in the following only consider the case  $c_2 = 0$ . It can be proved that this can also be achieved by choosing the coordinate system properly. We shall now identify the curves which are described by the equation (10). We shall assume that  $K > 0$ . Put

$$e = \frac{c_1}{K}.$$

(2) Prove that if  $|e| < 1$ , then the rectangular coordinates  $(x, y)$  of the planet satisfy an equation of the form

$$(x + a)^2 + \frac{y^2}{b^2} = c^2,$$

where  $a, b$  and  $c$  are constants.

What is this curve called?

(3) What is the equation in rectangular coordinates in case of  $|e| = 1$ ?

And what is the name of the corresponding curve?

(4) Finally, find the equation in rectangular coordinates and the type of the curves in case of  $|e| > 1$ .

**A.** Linear differential equation of second order and of constant coefficients. Conic sections. There are given some guidelines.

**D.** Follow the guidelines.

**I.** 1) The equation

$$\frac{d^2u}{d\theta^2} + u = K$$

has the characteristic polynomial  $R^2 + 1$  with the complex conjugated simple roots  $\pm i$ . The corresponding homogeneous equation has the complete solution

$$c_1 \cos \theta + c_2 \sin \theta,$$

where  $c_1, c_2 \in \mathbb{R}$  are arbitrary constants.

We see that  $u = K$  is a trivial solution, so the complete solution is given by

$$u(\theta) = K + c_1 \cos \theta + c_2 \sin \theta.$$

From  $u = \frac{1}{r}$  we get

$$r = \frac{1}{K + c_1 \cos \theta + c_2 \sin \theta},$$

which is defined whenever the denominator is positive, using the assumption that  $r > 0$ .

We then prove that we always can choose  $c_2 = 0$ . We have according to the addition formulæ,

$$\begin{aligned} c_1 \cos \theta + c_2 \sin \theta &= \sqrt{c_1^2 + c_2^2} \cdot \left\{ \frac{c_1}{\sqrt{c_1^2 + c_2^2}} \cos \theta + \frac{c_2}{\sqrt{c_1^2 + c_2^2}} \sin \theta \right\} \\ &= \sqrt{c_1^2 + c_2^2} \cdot \cos(\theta - \varphi), \end{aligned}$$

where  $\varphi$  is given by

$$\cos \varphi = \frac{c_1}{\sqrt{c_1^2 + c_2^2}}, \quad \sin \varphi = \frac{c_2}{\sqrt{c_1^2 + c_2^2}},$$

because

$$\left( \frac{c_1}{\sqrt{c_1^2 + c_2^2}}, \frac{c_2}{\sqrt{c_1^2 + c_2^2}} \right)$$

for  $(c_1, c_2) \neq (0, 0)$  is a unit vector and thus represents the angle  $\varphi$ .

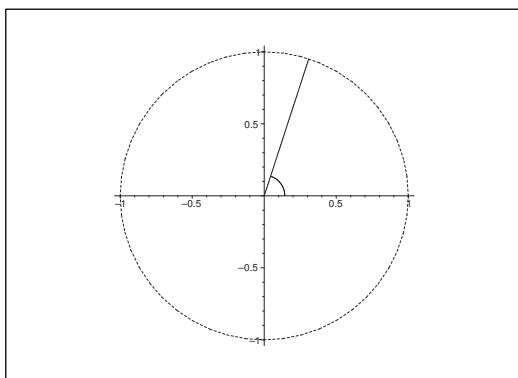

Figure 2: The unit vector determined by the direction  $(c_1, c_2)$ , i.e. by the angle  $\varphi$ .

Then choose the polar coordinate system in such a way that  $\varphi = 0$  or  $\varphi = \pi$ . Then write  $c_1$  instead of  $\pm\sqrt{c_1^2 + c_2^2}$ , where we choose the minus sign, if  $\varphi = \pi$ , and choose  $K > 0$  and  $e = \frac{c_1}{K}$ . Then we get the following

$$r = \frac{1}{K + c_1 \cos \theta} = \frac{1}{K} \cdot \frac{1}{1 + e \cos \theta},$$

where the *eccentricity*  $e$  must not be confused with the number  $e$ .

2) Assume that  $|e| < 1$ . Then  $1 + e \cos \theta > 0$  for all  $\theta$ . Then, by the above,

$$\frac{1}{K} = r(1 + e \cos \theta) = r + er \cos \theta = \sqrt{x^2 + y^2} + e \cdot x,$$

thus

$$\sqrt{x^2 + y^2} = \frac{1}{K} - e \cdot x \quad (> 0),$$

and hence by a squaring,

$$(11) \quad x^2 + y^2 = \frac{1}{K^2} - \frac{2e}{K}x + e^2x^2.$$

Then a rearrangement gives

$$(1 - e^2)x^2 + \frac{2e}{K}x + y^2 = \frac{1}{K^2},$$

hence by division by  $1 - e^2 > 0$  and addition of some convenient term,

$$\begin{aligned} x^2 + 2 \cdot \frac{e}{1 - e^2} \cdot \frac{1}{K} \cdot x + \left( \frac{e}{1 - e^2} \cdot \frac{1}{K} \right)^2 + \frac{1}{1 - e^2} y^2 \\ = \frac{1}{1 - e^2} \cdot \frac{1}{K^2} + \left( \frac{e}{1 - e^2} \cdot \frac{1}{K} \right)^2, \end{aligned}$$

which immediately is reduced to

$$(12) \quad \left( x + \frac{e}{1 - e^2} \cdot \frac{1}{K} \right)^2 + \frac{y^2}{(\sqrt{1 - e^2})^2} = \frac{1}{(1 - e^2)^2 K^2},$$

or

$$(x + a)^2 + \frac{y^2}{b^2} = c^2$$

where

$$a = \frac{e}{1 - e^2} \cdot \frac{1}{K}, \quad b = \sqrt{1 - e^2} \quad \text{and} \quad c = \frac{1}{(1 - e^2)K}.$$

This equation describes an ellipse with half axes

$$c = \frac{1}{(1 - e^2)K} \quad \text{and} \quad bc = \frac{1}{K\sqrt{1 - e^2}}.$$

3) When  $e = \pm 1$ , it follows from (11) that

$$x^2 + y^2 = \frac{1}{K^2} - \frac{2e}{K}x + x^2,$$

which is reduced to the parabolic equation

$$-2 \frac{e}{K}x + \frac{1}{K^2} = y^2, \quad e = \pm 1.$$

4) When  $|e| > 1$  and  $1 + e \cos \theta \neq 0$ , it follows from (11) that

$$(1 - e^2)x^2 + \frac{2e}{K^2}x + y^2 = \frac{1}{K^2},$$

which is reduced like in (2), only with the modification that we here have  $1 - e^2 < 0$  instead, i.e.  $e^2 - 1 > 0$ . Thus [cf. (12)]

$$\left( x - \frac{e}{e^2 - 1} \cdot \frac{1}{K} \right)^2 - \frac{y^2}{(\sqrt{e^2 - 1})^2} = \frac{1}{(e^2 - 1)^2 K^2},$$

which is the equation of a hyperbola.

**Example 1.36** Find the complete solution of the differential equation

$$\frac{d^2x}{dt^2} + 8 \frac{dx}{dt} + 15x = e^{-4t}, \quad t \in \mathbb{R}.$$

- A. Linear inhomogeneous differential equation of second order and of constant coefficients.  
 D. Find the roots of the characteristic equation and then find the solutions of the homogeneous equation. A particular solution can either be found by *guessing* or by the *solution formula*.  
 I. The characteristic equation

$$R^2 + 8R + 15 = (R + 3)(R + 5) = 0$$

has the two simple roots  $R = -3$  and  $R = -5$ . Thus, the complete solution of the homogeneous equation is

$$x = c_1 e^{-3t} + c_2 e^{-5t}, \quad c_1, c_2 \in \mathbb{R}, \quad t \in \mathbb{R}.$$

There are here two main variants of finding a particular solution.

.....Alcatel-Lucent 

[www.alcatel-lucent.com/careers](http://www.alcatel-lucent.com/careers)

What if you could build your future and create the future?

One generation's transformation is the next's status quo. In the near future, people may soon think it's strange that devices ever had to be "plugged in." To obtain that status, there needs to be "The Shift".



- 1. Guessing.** The right hand side  $q(t) = e^{-4t}$  is an exponential, which is not a solution of the corresponding homogeneous equation. We therefore *guess* on a solution of the form  $x = a e^{-4t}$ . By insertion into the left hand side of the differential equation we get

$$\frac{d^2x}{dt^2} + 8 \frac{dx}{dt} + 15x = 16a e^{-4t} - 32a e^{-4t} + 15a e^{-4t} = -a e^{-4t},$$

which is equal to  $e^{-4t}$  for  $a = -1$ . Thus the complete solution is

$$x = -e^{-4t} + c_1 e^{-3t} + c_2 e^{-5t}, \quad c_1, c_2 \in \mathbb{R}, \quad t \in \mathbb{R}.$$

- 2. Solution formula for linear equation of constant coefficients.** Let  $\alpha$  and  $\beta$  be the two (possibly equal) roots of the characteristic equation, and let  $q(t)$  be the right hand side of the normed differential equation of second order. Then

$$x = e^{\alpha t} \int e^{(\beta - \alpha)t} \left\{ \int e^{-\beta t} q(t) dt \right\} dt.$$

We have two variants:

- 1) Choosing  $\alpha = -3$  (and thus  $\beta = -5$ ) and  $q(t) = e^{-4t}$  we get

$$\begin{aligned} x &= e^{-3t} \int e^{(-5+3)t} \left\{ \int e^{5t} \cdot e^{-4t} dt \right\} dt = e^{-3t} \int e^{-2t} \left\{ \int e^t dt \right\} dt \\ &= e^{-3t} \int e^{-2t} \cdot e^t dt = e^{-3t} \{-e^{-t}\} = -e^{-4t}. \end{aligned}$$

- 2) Choosing  $\alpha = -5$  (and thus  $\beta = -3$ ) and  $q(t) = e^{-4t}$  we get

$$\begin{aligned} x &= e^{-5t} \int e^{(-3+5)t} \left\{ \int e^{3t} \cdot e^{-4t} dt \right\} dt = e^{-5t} \int e^{2t} \left\{ \int e^{-t} dt \right\} dt \\ &= e^{-5t} \int e^{2t} \{-e^{-t}\} dt = -e^{-5t} \cdot e^t = -e^{-4t}. \end{aligned}$$

In both cases we obtain the complete solution

$$x = -e^{-4t} + c_1 e^{-3t} + c_2 e^{-5t}, \quad c_1, c_2 \in \mathbb{R}, \quad t \in \mathbb{R}.$$

**Example 1.37** Find the complete solution of the differential equation

$$\frac{d^2x}{dt^2} - \frac{12}{5} \frac{dx}{dt} + \frac{8}{5} x = \cos 2t, \quad t \in \mathbb{R}.$$

- A.** Linear inhomogeneous differential equation of second order and of constant coefficients.  
**D.** Find the roots of the characteristic polynomial. Guess a particular solution.  
**I.** When we factorize the characteristic polynomial we get

$$R^2 - \frac{12}{5} R + \frac{8}{5} = \left( R - \left\{ \frac{6}{5} + \frac{2i}{5} \right\} \right) \left( R - \left\{ \frac{6}{5} - \frac{2i}{5} \right\} \right).$$

The roots are  $\frac{6}{5} \pm \frac{2i}{5}$ , so the complete solution of the homogeneous equation is

$$x = c_1 \exp\left(\frac{6}{5}t\right) \cos\left(\frac{2t}{5}\right) + c_2 \exp\left(\frac{6}{5}t\right) \sin\left(\frac{2t}{5}\right), \quad t \in \mathbb{R},$$

where  $c_1$  and  $c_2 \in \mathbb{R}$  are arbitrary constants.

The corresponding complex equation is

$$\frac{d^2x}{dt^2} - \frac{12}{5} \frac{dx}{dt} + \frac{8}{5}x = e^{2it}.$$

By guessing  $x = a e^{2it}$  we get by insertion

$$\begin{aligned} \frac{d^2x}{dt^2} - \frac{12}{5} \frac{dx}{dt} + \frac{8}{5}x &= a \left\{ (2i)^2 - \frac{12}{5} \cdot 2i + \frac{8}{5} \right\} e^{2it} \\ &= a \left\{ -4 + \frac{8}{5} - \frac{24}{5}i \right\} e^{2it} = a \left\{ -\frac{12}{5} - \frac{24}{5}i \right\} e^{2it} \\ &= -\frac{12}{5} (1 + 2i)a e^{2it}. \end{aligned}$$

This is equal to  $e^{2it}$  for

$$a = -\frac{5}{12} \cdot \frac{1}{1 + 2i} = -\frac{1 - 2i}{12}.$$

The corresponding solution of the real equation is

$$\begin{aligned} x &= \operatorname{Re} \left\{ -\frac{1 - 2i}{12} e^{2it} \right\} \\ &= -\frac{1}{12} \operatorname{Re} \{ (1 - 2i)(\cos 2t + i \sin 2t) \} \\ &= -\frac{1}{12} (\cos 2t + 2 \sin 2t). \end{aligned}$$

Hence the complete solution is

$$\begin{aligned} x &= -\frac{1}{12} \{ \cos 2t + 2 \sin 2t \} \\ &\quad + c_1 \exp\left(\frac{6}{5}t\right) \cos\left(\frac{2t}{5}\right) + c_2 \exp\left(\frac{6}{5}t\right) \sin\left(\frac{2t}{5}\right), \quad t \in \mathbb{R}, \end{aligned}$$

where  $c_1$  and  $c_2 \in \mathbb{R}$  are arbitrary constants.

**C. TEST.** If

$$x = -\frac{1}{2} \cos 2t - \frac{1}{6} \sin 2t,$$

then

$$\frac{dx}{dt} = -\frac{1}{3} \cos 2t + \frac{1}{6} \sin 2t, \quad \frac{d^2x}{dt^2} = \frac{1}{3} \cos 2t + \frac{2}{3} \sin 2t,$$

hence

$$\begin{aligned} \frac{d^2x}{dt^2} - \frac{12}{5} \frac{dx}{dt} + \frac{8}{5}x &= \frac{1}{3} \cos 2t + \frac{2}{3} \sin 2t + \frac{4}{5} \cos 2t - \frac{2}{5} \sin 2t \\ &\quad - \frac{2}{15} \cos 2t - \frac{4}{15} \sin 2t \\ &= \frac{1}{15} \{ (5 + 12 - 2) \cos 2t + (10 - 6 - 4) \sin 2t \} \\ &= \cos 2t. \quad \text{Q.E.D.} \end{aligned}$$



We shall omit the test of the solutions of the homogeneous equation.

**Example 1.38** Find the complete real solution of the differential equation

$$\frac{d^2x}{dt^2} - \frac{4}{5} \frac{dx}{dt} + \frac{8}{5}x = \cos t.$$

**A.** Linear inhomogeneous differential equation of second order and of constant coefficients.

**D.** Solve the characteristic equation, and guess a particular solution.

**I.** The characteristic equation

$$R^2 - \frac{4}{5}R + \frac{8}{5} = 0$$

has the roots

$$R = \frac{2}{5} \pm \sqrt{\frac{4}{25} - \frac{40}{25}} = \frac{2}{5} \pm \frac{6i}{5}.$$

Thus, the homogeneous equation has the complete solution

$$x = c_1 \exp\left(\frac{2t}{5}\right) \cos\left(\frac{6t}{5}\right) + c_2 \exp\left(\frac{2t}{5}\right) \sin\left(\frac{6t}{5}\right), \quad t \in \mathbb{R},$$

where  $c_1, c_2 \in \mathbb{R}$  are arbitrary constants.

The corresponding complex equation is

$$\frac{d^2x}{dt^2} - \frac{4}{5} \frac{dx}{dt} + \frac{8}{5}x = e^{it}.$$

If we put  $x = a e^{it}$ , then we get by insertion,

$$\frac{d^2x}{dt^2} - \frac{4}{5} \frac{dx}{dt} + \frac{8}{5}x = a \left\{ -1 - \frac{4}{5}i + \frac{8}{5} \right\} e^{it} = \frac{3-4i}{5} a e^{it},$$

which is equal to  $e^{it}$  for  $a = \frac{5}{3-4i} = \frac{3+4i}{5}$ .

The corresponding complete solution of the real equation is

$$\begin{aligned} x &= \operatorname{Re} \left\{ \frac{3+4i}{5} e^{it} \right\} \\ &= \frac{1}{5} \operatorname{Re} \{ (3+4i)(\cos t + i \sin t) \} \\ &= \frac{1}{5} \{ 3 \cos t - 4 \sin t \}. \end{aligned}$$

The complete solution is

$$x = \frac{1}{5} \{ 3 \cos t - 4 \sin t \} + c_1 \exp\left(\frac{2t}{5}\right) \cos\left(\frac{6t}{5}\right) + c_2 \exp\left(\frac{2t}{5}\right) \sin\left(\frac{6t}{5}\right), \quad t \in \mathbb{R},$$

where  $c_1$  and  $c_2 \in \mathbb{R}$  are arbitrary constants.

**Example 1.39** Find the complete real solution of the differential equation

$$\frac{d^2x}{dt^2} + 6\frac{dx}{dt} + 25x = 0, \quad t \in \mathbb{R}.$$

- A. Linear homogeneous differential equation of second order and of constant coefficients. Cf. also Example 1.40.
- D. Solve the characteristic polynomial.
- I. The characteristic polynomial  $R^2 + 6R + 25 = (R + 3)^2 + 4^2$  has the two simple and complex conjugated roots  $R = -3 \pm 4i$ . The complete solution is

$$x = c_1 e^{-3t} \cos 4t + c_2 e^{-3t} \sin 4t, \quad c_1, c_2 \in \mathbb{R}, \quad t \in \mathbb{R}.$$



**Maastricht University**

*Leading  
in Learning!*

Join the best at  
the Maastricht University  
School of Business and  
Economics!

**Top master's programmes**

- 33<sup>rd</sup> place Financial Times worldwide ranking: MSc International Business
- 1<sup>st</sup> place: MSc International Business
- 1<sup>st</sup> place: MSc Financial Economics
- 2<sup>nd</sup> place: MSc Management of Learning
- 2<sup>nd</sup> place: MSc Economics
- 2<sup>nd</sup> place: MSc Econometrics and Operations Research
- 2<sup>nd</sup> place: MSc Global Supply Chain Management and Change

Sources: Keuzegids Master ranking 2013; Elsevier 'Beste Studies' ranking 2012; Financial Times Global Masters in Management ranking 2012

**Maastricht  
University is  
the best specialist  
university in the  
Netherlands  
(Elsevier)**

**Visit us and find out why we are the best!  
Master's Open Day: 22 February 2014**

[www.mastersopenday.nl](http://www.mastersopenday.nl)



**Example 1.40** Find the complete real solution of the differential equation

$$\frac{d^2x}{dt^2} + 6 \frac{dx}{dt} + 25x = \cos 5t, \quad t \in \mathbb{R}.$$

- A.** Linear inhomogeneous differential equation of second order and of constant coefficients. Cf. also Example 1.39.
- D.** Solve the characteristic polynomial. Guess a particular solution.
- I.** The characteristic polynomial  $R^2 + 6R + 25 = (R + 3)^2 + 4^2$  has the simple and complex conjugated roots  $R = -3 \pm 4i$ . The complete solution of the homogeneous equation is

$$c_1 e^{-3t} \cos 4t + c_2 e^{-3t} \sin 4t, \quad c_1, c_2 \in \mathbb{R}, \quad t \in \mathbb{R}.$$

If we guess the complex exponential  $x = c \cdot e^{5it}$ , then by insertion,

$$\frac{d^2x}{dt^2} + 6 \frac{dx}{dt} + 25x = c\{-25 + 5i \cdot 6 + 25\}e^{5it} = 30ic e^{5it},$$

which is equal to  $e^{5it}$  for  $c = \frac{1}{30i}$ . From  $\cos 5t = \operatorname{Re} e^{5it}$ , we get the particular solution

$$x = \operatorname{Re} \left\{ \frac{1}{30i} e^{5it} \right\} = \frac{1}{30} \sin 5t,$$

which is easily checked. The complete solution is

$$x = \frac{1}{30} \sin 5t + c_1 e^{-3t} \cos 4t + c_2 e^{-3t} \sin 4t, \quad t \in \mathbb{R},$$

where  $c_1, c_2 \in \mathbb{R}$  are arbitrary constants.

**Example 1.41** Find the complete solution of the differential equation

$$\frac{d^2x}{dt^2} + 4 \frac{dx}{dt} + 5x = \cos 2t, \quad t \in \mathbb{R}.$$

- A.** Linear inhomogeneous differential equation of second order and of constant coefficients.
- D.** Find the roots of the characteristic polynomial. Guess a particular solution.
- I.** The characteristic polynomial  $R^2 + 4R + 5 = (R + 2)^2 + 1$  has the two simple and complex conjugated roots  $-2 \pm i$ , hence the complete solution of the homogeneous equation is

$$c_1 e^{-2t} \cos t + c_2 e^{-2t} \sin t, \quad c_1, c_2 \in \mathbb{R}, \quad t \in \mathbb{R}.$$

Then guess on the complex exponential  $x = c \cdot e^{2it}$ . By insertion we get

$$\frac{d^2x}{dt^2} + 4 \frac{dx}{dt} + 5x = c\{-4 + 8i + 5\}e^{2it} = c(1 + 8i)e^{2it},$$

which is equal to  $e^{2it}$  for  $c = \frac{1}{1 + 8i} = \frac{1 - 8i}{65}$ . Thus, a particular solution is

$$\operatorname{Re} \left\{ \frac{1 - 8i}{65} e^{2it} \right\} = \frac{1}{65} \{\cos 2t + 8 \sin 2t\},$$

and the complete solution is

$$x = \frac{1}{65} \{ \cos 2t + 8 \sin 2t \} + c_1 e^{-2t} \cos t + c_2 e^{-2t} \sin t, \quad t \in \mathbb{R},$$

where  $c_1, c_2 \in \mathbb{R}$  are arbitrary constants.

**Example 1.42** Find the complete solution of the differential equation

$$\frac{d^2 x}{dt^2} - 4 \frac{dx}{dt} + 4x = e^{2t}, \quad t \in \mathbb{R}.$$

- A.** Linear inhomogeneous differential equation of second order and of constant coefficients.  
**D.** Analyze the characteristic polynomial. Guess a particular solution.  
**I.** The characteristic polynomial  $R^2 - 4R + 4 = (R - 2)^2$  has the double root  $R = 2$ , thus the complete solution of the homogeneous equation is

$$c_1 e^{2t} + c_2 t e^{2t}, \quad c_1, c_2 \in \mathbb{R}, \quad t \in \mathbb{R}.$$

We see that the right hand side of the equation is a solution of the homogeneous equation. We therefore guess on  $c \cdot t e^{2t}$ . However, this function is also a solution of the homogeneous equation, so we must change our guess to  $x = c \cdot t^2 e^{2t}$ . Then

$$\frac{dx}{dt} = 2ct^2 e^{2t} + 2cte^{2t}$$

and

$$\frac{d^2 x}{dt^2} = 4ct^2 e^{2t} + 8cte^{2t} + 2ce^{2t}.$$

By insertion we obtain the result  $2ce^{2t}$ , so the wanted solution is obtained by choosing  $c = \frac{1}{2}$ .

the complete solution is

$$x = \frac{1}{2} t^2 e^{2t} + c_1 e^{2t} + c_2 t e^{2t}, \quad c_1, c_2 \in \mathbb{R}, \quad t \in \mathbb{R}.$$

## 2 Linear differential equations of higher order and of constant coefficients

**Example 2.1** Solve the following differential equations

1)  $\frac{d^3x}{dt^3} - \frac{d^2x}{dt^2} + \frac{dx}{dt} - x = 0, t \in \mathbb{R}.$

2)  $\frac{d^4x}{dt^4} + x = 0, t \in \mathbb{R}.$

**A.** Homogeneous linear differential equation of constant coefficients of third and fourth order, resp..

**D.** Find the roots of the characteristic polynomial.

**I.** 1) The characteristic polynomial

$$R^3 - R^2 + R - 1 = (R - 1)(R^2 + 1)$$

has the three simple roots 1 and  $\pm i$ . Hence the complete solution is

$$x = c_1 e^t + c_2 \cos t + c_3 \sin t, \quad c_1, c_2, c_3 \in \mathbb{R}, \quad t \in \mathbb{R}.$$

2) The characteristic polynomial  $R^4 + 1$  has the four simple roots

$$\pm \frac{1}{\sqrt{2}} \pm i \frac{1}{\sqrt{2}},$$

all four combinations of the signs: Hence, the complete solution is

$$\begin{aligned} x = & c_1 \exp\left(\frac{1}{\sqrt{2}} t\right) \cos \frac{1}{\sqrt{2}} t + c_2 \exp\left(\frac{1}{\sqrt{2}} t\right) \sin \frac{1}{\sqrt{2}} t \\ & + c_3 \exp\left(-\frac{1}{\sqrt{2}} t\right) \cos \frac{1}{\sqrt{2}} t + c_4 \exp\left(-\frac{1}{\sqrt{2}} t\right) \sin \frac{1}{\sqrt{2}} t, \end{aligned}$$

where  $t \in \mathbb{R}$ , and  $c_1, c_2, c_3, c_4 \in \mathbb{R}$  are arbitrary constants.

**Example 2.2** Solve the following differential equations

1)  $\frac{d^3x}{dt^3} - 3 \frac{d^2x}{dt^2} + 3 \frac{dx}{dt} - x = 0, t \in \mathbb{R}.$

2)  $\frac{d^4x}{dt^4} + 2 \frac{d^2x}{dt^2} + x = 0, t \in \mathbb{R}.$

**A.** Homogeneous linear differential equations of constant coefficients of third and fourth order, resp..

**D.** Find the roots of the characteristic polynomials and thus the structure of the solutions. Finally, find the complete solution

**I.** 1) The characteristic polynomial  $R^3 - 3R^2 + 3R - 1 = (R - 1)^3$  has  $R = 1$  as a treble root. Thus the complete solution is

$$x = c_1 e^t + c_2 t e^t + c_3 t^2 e^t, \quad c_1, c_2, c_3 \in \mathbb{R}, \quad t \in \mathbb{R}.$$

- 2) The characteristic polynomial  $R^4 + 2R^2 + 1 = (R^2 + 1)^2$  has  $R = \pm i$  as double roots. The complete solution is

$$x) c_1 \cos t + c_2 \sin t + c_3 t \cos t + c_4 t \sin t,$$

where  $c_1, c_2, c_3, c_4 \in \mathbb{R}$  are arbitrary constants, and  $t \in \mathbb{R}$ .

**Example 2.3** Solve the following differential equations

1)  $\frac{d^4 x}{dt^4} + \frac{d^3 x}{dt^3} - \frac{dx}{dt} - x = 0, t \in \mathbb{R}.$

2)  $\frac{d^6 x}{dt^6} + 9 \frac{d^4 x}{dt^4} + 24 \frac{d^2 x}{dt^2} + 16x = 0, t \in \mathbb{R}.$

- A. Homogeneous linear differential equations of constant coefficients of order four and six, resp..  
 D. Find the roots of the characteristic polynomials.



**> Apply now**

REDEFINE YOUR FUTURE  
**AXA GLOBAL GRADUATE  
 PROGRAM 2015**

redefining / standards 

agence edg. © Photonstop



I. 1) The characteristic polynomial

$$R^4 + R^3 - R - 1 = (R + 1)(R^3 - 1) = (R + 1)(R - 1)(R^2 + R + 1)$$

has the simple roots  $\pm 1$  and  $-\frac{1}{2} \pm i \frac{\sqrt{3}}{2}$ , thus the complete solution is

$$x = c_1 e^t + c_2 e^{-t} + c_3 \exp\left(-\frac{1}{2}t\right) \cos \frac{\sqrt{3}}{2}t + c_4 \exp\left(-\frac{1}{2}t\right) \sin \frac{\sqrt{3}}{2}t,$$

where  $c_1, c_2, c_3, c_4 \in \mathbb{R}$  are arbitrary constants, and  $t \in \mathbb{R}$ .

2) The characteristic polynomial  $R^6 + 9R^4 + 24R^2 + 16$  can be considered as an equation in the new variable  $U = R^2$ . We see that  $R^2 + 1$  is a divisor. Then we get the factorization

$$R^6 + 9R^4 + 24R^2 + 16 = (R^2 + 1)(R^4 + 8R^2 + 16) = (R^2 + 1)(R^2 + 4)^2.$$

Thus the complex roots are  $\pm i$  (simple roots) and  $\pm 2i$  (double roots). The complete solution is

$$x = c_1 \cos t + c_2 \sin t + c_3 \cos 2t + c_4 \sin 2t + c_5 t \cos 2t + c_6 t \sin 2t,$$

where  $c_1, c_2, c_3, c_4, c_5, c_6 \in \mathbb{R}$  are arbitrary constants, and  $t \in \mathbb{R}$ .

**Example 2.4** Find a particular solution of the differential equation

$$\frac{d^3x}{dt^3} + 3 \frac{d^2x}{dt^2} + 3 \frac{dx}{dt} + x = e^t \cos 2t, \quad t \in \mathbb{R}.$$

A. Linear inhomogeneous differential equation of third order and of constant coefficients. We shall only find a particular solution. The example is almost the same as Example 2.8, so we also refer to this example.

D. Guess a complex exponential  $x = c \cdot e^{(1+2i)t}$ .

Although it is not required, we shall nevertheless also solve the homogeneous equation.

I. If we put  $x = c \cdot e^{(1+2i)t}$  into the left hand side of the equation, we get

$$\begin{aligned} \frac{d^3x}{dt^3} + 3 \frac{d^2x}{dt^2} + 3 \frac{dx}{dt} + x &= c \left\{ (1+2i)^3 + 3(1+2i)^2 + 3(1+2i) + 1 \right\} e^{(1+2i)t} \\ &= c \{ 1 + (1+2i) \}^3 e^{(1+2i)t} = 8c(1+i)^3 e^{(1+2i)t} \\ &= 8c \cdot 2i(1+i) e^{(1+2i)t} = 16(-1+i)c e^{(1+2i)t}. \end{aligned}$$

This is equal to  $e^{(1+2i)t}$  for  $c = \frac{1}{16} \cdot \frac{1}{-1+i} = \frac{-1-i}{32}$ , so a solution of the corresponding real equation is

$$\operatorname{Re} \left\{ \frac{-1-i}{32} e^{(1+2i)t} \right\} = -\frac{1}{32} e^t \operatorname{Re} \{ (1+i)e^{2it} \} = \frac{1}{32} e^t \sin 2t - \frac{1}{32} e^t \cos 2t.$$

REMARK. The characteristic polynomial  $R^3 + 3R^2 + 3R + 1 = (R+1)^3$  has the treble root  $R = -1$ , hence the complete solution of the homogeneous equation is

$$c_1 e^{-t} + c_2 t e^{-t} + c_3 t^2 e^{-t}, \quad c_1, c_2, c_3 \in \mathbb{R}, \quad t \in \mathbb{R}.$$

Then the complete solution of the original inhomogeneous equation is

$$x = \frac{1}{32} e^t \sin 2t - \frac{1}{32} e^t \cos 2t + c_1 e^{-t} + c_2 t e^{-t} + c_3 t^2 e^{-t},$$

where  $c_1, c_2, c_3 \in \mathbb{R}$  are arbitrary constants, and  $t \in \mathbb{R}$ .

**Example 2.5** Given for the differential equation

$$\frac{d^3 x}{dt^3} + a_2 \frac{d^2 x}{dt^2} + a_1 \frac{dx}{dt} + a_0 x = q(t), \quad t \in \mathbb{R},$$

that the functions

$$e^t - e^t \cos t \quad \text{and} \quad e^t + 3e^{-t}$$

are both solutions. Find the complete solution of the corresponding homogeneous equation.

**A.** Linear inhomogeneous differential equation of third order and of constant coefficients. The constants and the right hand side are not known; but we are given two solutions of the inhomogeneous equation. Apparently we have got too little information, so the task requires a theoretical analysis.

**D.** Exploit that the difference between the two solutions is a solution of the corresponding homogeneous equation. Insert this difference into the left hand side of the equation and then calculate the coefficients. When we have found  $a_2, a_1$  and  $a_0$ , then the rest is easy.

The solution below is given in three sections, of which (2) concerning the uniqueness is obligatory, and where only one of the points (1) concerning the existence is necessary.

**I.** 1) The difference

$$x = (e^t + 3e^{-t}) - (e^t - e^t \cos t) = 3e^{-t} + e^t \cos t,$$

is a solution of the homogeneous equation, and the coefficients are constant. This gives us the idea that the three linearly independent solutions of the homogeneous equation are given by

$$e^{-t}, \quad e^t \cos t, \quad e^t \sin t,$$

corresponding to the characteristic polynomial

$$(R+1)(R-1-i)(R-1+i) = (R+1)(R^2 - 2R + 2) = R^3 - R^2 + 2,$$

hence to the differential equation

$$(13) \quad \frac{d^3 x}{dt^3} - \frac{d^2 x}{dt^2} + 2x = q(t).$$

First assume that the equation is given by (13). Then we obtain  $q(t)$  by putting  $x = e^t$  into the left hand side of the equation, thus  $q(t) = 2e^t$ , and the equation becomes

$$(14) \quad \frac{d^3 x}{dt^3} - \frac{d^2 x}{dt^2} + 2x = 2e^t.$$



Clearly, the complete solution of (14) is given by

$$x = e^t + c_1 e^{-t} + c_2 e^t \cos t + c_3 e^t \sin t, \quad c_1, c_2, c_3 \in \mathbb{R}, \quad t \in \mathbb{R},$$

and we see that the given solutions  $e^t - e^t \cos t$  and  $e^t + 3e^{-t}$  are among these. This proves the *existence* of such an equation.

- 2) The *uniqueness* is far from obvious, since we have only the knowledge of two solutions, and we shall find three constants and the function  $q(t)$ . Therefore the problem apparently lacks some information.

It will later turn up that the assumption that the coefficients are constant (they may be complex in the following), and the information that

$$e^t \cos t = \operatorname{Re} \left\{ e^{(1+i)t} \right\}$$

occurs in the solution actually secures that

$$e^t \sin t = \operatorname{Im} \left\{ e^{(1+i)t} \right\}$$

also must occur in the solution. In fact:

We know that

$$x = 3e^{-t} + e^t \cos t = 3e^{-t} + \operatorname{Re} \left\{ e^{(1+i)t} \right\}$$

is a solution of the homogeneous equation. We shall now see what this means. First we calculate

$$\begin{aligned} \frac{dx}{dt} &= -3e^{-t} + \operatorname{Re} \left\{ (1+i)e^{(1+i)t} \right\}, \\ \frac{d^2x}{dt^2} &= 3e^{-t} + \operatorname{Re} \left\{ (1+i)^2 e^{(1+i)t} \right\}, \\ \frac{d^3x}{dt^3} &= -3e^{-t} + \operatorname{Re} \left\{ (1+i)^3 e^{(1+i)t} \right\}, \end{aligned}$$

thus by insertion

$$\begin{aligned} \frac{d^3x}{dt^3} + a_2 \frac{d^2x}{dt^2} + a_1 \frac{dx}{dt} + a_0 x &= -3e^{-t} + \operatorname{Re} \left\{ 2i(1+i)e^{(1+i)t} \right\} + a_2 \left\{ 3e^{-t} + \operatorname{Re} \left\{ 2ie^{(1+i)t} \right\} \right\} \\ &\quad + a_1 \left\{ -3e^{-t} + \operatorname{Re} \left\{ (1+i)e^{(1+i)t} \right\} \right\} + a_0 \left\{ 3e^{-t} + \operatorname{Re} \left\{ e^{(1+i)t} \right\} \right\} \\ &= (-3 + 3a_2 - 3a_1 + 3a_0)e^{-t} + 2e^t \operatorname{Re} \left\{ (-1+i)e^{it} \right\} + 2a_2 e^t \operatorname{Re} \left\{ ie^{it} \right\} \\ &\quad + a_1 e^t \operatorname{Re} \left\{ (1+i)e^{it} \right\} + a_0 e^t \operatorname{Re} \left\{ e^{it} \right\} \\ &= 3(a_0 - a_1 + a_2 - 1)e^{-t} + 2e^t \{-\cos t - \sin t\} + 2a_2 e^t \{-\sin t\} \\ &\quad + a_1 e^t \{\cos t - \sin t\} + a_0 e^t \cos t \\ &= 3(a_0 - a_1 + a_2 - 1)e^{-t} \\ &\quad + (-2 + a_1 + a_0)e^t \cos t + (-2 - 2a_2 - a_1)e^t \sin t, \end{aligned}$$

where we see that the term  $e^t \sin t$  turns up.

The functions  $e^{-t}$ ,  $e^t \cos t$  and  $e^t \sin t$  are linearly independent. Therefore, this expression is 0, if and only if

$$\begin{cases} a_0 - a_1 + a_2 = 1, \\ a_0 + a_1 = 2, \\ a_1 + 2a_2 = -2, \end{cases} \quad \text{i.e.} \quad \begin{cases} 2a_0 - 2a_1 + 2a_2 = 2, \\ 3a_0 + 3a_1 = 6, \\ -a_1 - 2a_2 = 2. \end{cases}$$

When we add the latter three equations, we get  $5a_0 = 10$ , or  $a_0 = 2$ , and then (second equation)  $a_1 = 0$  and  $a_2 = -1$ , and we can now write the equation in the form

$$\frac{d^3x}{dt^3} - \frac{d^2x}{dt^2} + 2x = q(t), \quad t \in \mathbb{R},$$

proving the *uniqueness*.



## Empowering People. Improving Business.

BI Norwegian Business School is one of Europe's largest business schools welcoming more than 20,000 students. Our programmes provide a stimulating and multi-cultural learning environment with an international outlook ultimately providing students with professional skills to meet the increasing needs of businesses.

BI offers four different two-year, full-time Master of Science (MSc) programmes that are taught entirely in English and have been designed to provide professional skills to meet the increasing need of businesses. The MSc programmes provide a stimulating and multi-cultural learning environment to give you the best platform to launch into your career.

- MSc in Business
- MSc in Financial Economics
- MSc in Strategic Marketing Management
- MSc in Leadership and Organisational Psychology

[www.bi.edu/master](http://www.bi.edu/master)

**BI NORWEGIAN BUSINESS SCHOOL**

EFMD  
**EQUIS**  
ACCREDITED



- 3) If we did not start with the very intuitive point (1), then we proceed in the following way:  
The corresponding characteristic polynomial

$$R^3 - R^2 + 2 = (R + 1)(R^2 - 2R + 2)$$

has the simple roots  $R = -1$  and  $R = 1 \pm i$ , hence the complete solution of the homogeneous equation is

$$c_1 e^{-t} + c_2 e^t \cos t + c_3 e^t \sin t, \quad c_1, c_2, c_3 \in \mathbb{R}, \quad t \in \mathbb{R}.$$

Now,  $e^t - e^t \cos t$  is a solution of the equation, and  $e^t \cos t$  is a solution of the homogeneous equation. This shows that  $x = e^t$  is a particular solution. When it is put into the left hand side of the equation, we obtain

$$q(t) = \frac{d^3 x}{dt^3} - \frac{d^2 x}{dt^2} + 2x = e^t - e^t + 2e^t = 2e^t,$$

and the equation becomes

$$\frac{d^3 x}{dt^3} - \frac{d^2 x}{dt^2} + 2x = 2e^t,$$

where the complete solution is

$$e^t + c_1 e^{-t} + c_2 e^t \cos t + c_3 e^t \sin t, \quad c_1, c_2, c_3 \in \mathbb{R}, \quad t \in \mathbb{R}.$$

**Example 2.6** For the differential equation

$$\frac{d^4 x}{dt^4} + a_3 \frac{d^3 x}{dt^3} + a_2 \frac{d^2 x}{dt^2} + a_1 \frac{dx}{dt} + a_0 x = q(t), \quad t \in \mathbb{R},$$

we get the information that the functions

$$\cos t, \quad \cos t + 2 \sin 2t - \cos 2t, \quad \cos t - e^t + 3e^{-t}$$

are all solutions. Find the numbers  $a_0, a_1, a_2, a_3$  and the function  $q(t)$ .

- A.** Linear inhomogeneous differential equation of fourth order and of (unknown) constant coefficients and an unknown right hand side. We know three solutions of the inhomogeneous equation. Find the constants and the right hand side. Note that the complete solution is not requested.
- D.** The difference of any two of the given solutions must be a solution of the corresponding homogeneous equation. Insert these solutions and find the coefficients. Finally we insert one solution in order to get  $q(t)$ .
- I.** It is first seen that the two differences

$$\{\cos t + 2 \sin 2t - \cos 2t\} - \cos t = 2 \sin 2t - \cos 2t,$$

and

$$\{\cos t - e^t + 3e^{-t}\} - \cos t = -e^t + 3e^{-t},$$

are both solutions of the homogeneous equation. Then a QUALIFIED GUESS is that the characteristic polynomial must contain the factors  $R^2 + 4$  (corresponding to  $c_1 \cos 2t + c_2 \sin 2t$ ) and  $R^2 - 1$  (corresponding to  $c_3 e^t + c_4 e^{-t}$ ), thus the characteristic polynomial is probably given by

$$(R^2 + 1)(R^2 - 1) = R^4 + 3R^2 - 4,$$

corresponding to

$$\frac{d^4 x}{dt^4} + 3 \frac{d^2 x}{dt^2} - 4x = q(t).$$

If we insert the solution  $x = \cos t$ , we get in this case

$$q(t) = \cos t - 3 \cos t - 4 \cos t = -6 \cos t.$$

We may therefore expect that the equation is

$$(15) \quad \frac{d^4 x}{dt^4} + 3 \frac{d^2 x}{dt^2} - 4x = -6 \cos t,$$

which has the complete solution

$$\cos t + c_1 \cos 2t + c_2 \sin 2t + c_3 e^t + c_4 e^{-t}, \quad t \in \mathbb{R},$$

where  $c_1, c_2, c_3, c_4 \in \mathbb{R}$  are arbitrary constants.

Notice that (15) clearly satisfies the conditions, so we have at least found one solution.

We shall now prove that the model above is UNIQUE. If we insert a solution of the homogeneous equation

$$\begin{aligned} x &= 2 \sin 2t - \cos 2t, \\ \frac{dx}{dt} &= 2 \sin 2t + 4 \cos 2t, \\ \frac{d^2 x}{dt^2} &= -8 \sin 2t + 4 \cos 2t, \\ \frac{d^3 x}{dt^3} &= -8 \sin 2t - 16 \cos 2t, \\ \frac{d^4 x}{dt^4} &= 32 \sin 2t - 16 \cos 2t, \end{aligned}$$

into the left hand side of the equation, we get

$$\begin{aligned} &\frac{d^4 x}{dt^4} + a_3 \frac{d^3 x}{dt^3} + a_2 \frac{d^2 x}{dt^2} + a_1 \frac{dx}{dt} + a_0 x \\ &= 32 \sin 2t - 16 \cos 2t \\ &\quad - 8a_3 \sin 2t - 16a_3 \cos 2t \\ &\quad - 8a_2 \sin 2t + 4a_2 \cos 2t \\ &\quad + 2a_1 \sin 2t + 4a_1 \cos 2t \\ &\quad + 2a_0 \sin 2t - a_0 \cos 2t \\ &= 2(16 - 4a_3 - 4a_2 + a_1 + a_0) \sin 2t - (16 + 16a_3 - 4a_2 - 4a_1 + a_0) \cos 2t. \end{aligned}$$

Now,  $\sin 2t$  and  $\cos 2t$  are linearly independent. Therefore this expression is 0, if and only if

$$\begin{cases} a_0 + a_1 - 4a_2 - 4a_3 = -16, \\ a_0 - 4a_1 - 4a_2 + 16a_3 = -16, \end{cases}$$

Put  $b_1 = a_0 - 4a_2$  and  $b_2 = a_1 - 4a_3$ . Then

$$b_1 = a_0 - 4a_2 = -16, \quad b_2 = a_1 - 4a_3 = 0.$$

Then let

$$x = -e^t + 3e^{-t} = \frac{d^2x}{dt^2} = \frac{d^4x}{dt^4},$$

and

$$\frac{dx}{dt} = -e^t - 3e^{-t} = \frac{d^3x}{dt^3},$$

from which

$$\begin{aligned} \frac{d^4x}{dt^4} + a_3 \frac{d^3x}{dt^3} + a_2 \frac{d^2x}{dt^2} + a_1 \frac{dx}{dt} + a_0 x \\ &= (1 + a_2 + a_0)x + (a_3 + a_1) \frac{dx}{dt} \\ &= (1 + a_2 + a_0)(-e^t + 3e^{-t}) - (a_3 + a_1)(e^t + 3e^{-t}) \\ &\quad - (1 + a_2 + a_0 + a_3 + a_1)e^t + 3(1 + a_2 + a_0 - a_3 - a_1)e^{-t}. \end{aligned}$$

Since  $e^t$  and  $e^{-t}$  are linearly independent, this is 0, if and only if

$$\begin{cases} (1 + a_2 + a_0) + (a_3 + a_1) = 0, \\ (1 + a_2 + a_0) - (a_3 + a_1) = 0, \end{cases}$$

hence

$$a_1 + a_3 = 0 \quad \text{and} \quad a_0 + a_2 = -1.$$

We shall now only solve the four equations

$$\begin{cases} a_0 - 4a_2 = -16, \\ a_0 + a_2 = -1, \end{cases} \quad \begin{cases} a_1 = 4a_3, \\ a_1 = -a_3, \end{cases}$$

from which it is seen that  $a_1 = a_3 = 0$ , and  $-5a_2 = -15$ , thus  $a_2 = 3$  and  $a_0 = -4$ . Therefore we get precisely

$$\frac{d^4x}{dt^4} + 3 \frac{d^2x}{dt^2} - 4x = q(t),$$

hence by insertion of the solution  $x = \cos t$  of the inhomogeneous equation we get  $q(t) = -6 \cos t$ , and the equation becomes

$$\frac{d^4x}{dt^4} + 3 \frac{d^2x}{dt^2} - 4x = -6 \cos t,$$

so we have proved the uniqueness.

**Example 2.7** Given the complete solution of an inhomogeneous linear differential equation of order  $n$ ,

$$x = c_1 \cos 2t + c_2 \sin 2t + c_3 + c_4 t + t^2, \quad t \in \mathbb{R}.$$

Find  $n$  and the equation.

- A.** From the information of the complete solution of a linear inhomogeneous equation of unknown order  $n$ , though of constant coefficients, we shall find the order  $n$  and reconstruct the differential equation.
- D.** First find the characteristic polynomial, and then insert the particular solution.
- I.** Since we have four arbitrary constants, the order must be  $n = 4$ .

Since  $\cos 2t = \operatorname{Re} e^{2it}$  and  $\sin 2t = \operatorname{Im} e^{2it}$  are solutions of the homogeneous equation, the factor  $R^2 + 4$  must occur in the characteristic polynomial.

Since  $1 = e^{0 \cdot t}$  and  $t = t \cdot e^{0 \cdot t}$  are solutions of the homogeneous equation, we must have the double root  $R = 0$  in the characteristic polynomial, so  $R^2$  is also a factor in the polynomial.

## Need help with your dissertation?

Get in-depth feedback & advice from experts in your topic area. Find out what you can do to improve the quality of your dissertation!

Get Help Now



Go to [www.helpmyassignment.co.uk](http://www.helpmyassignment.co.uk) for more info



Click on the ad to read more

When we collect these things we see that the characteristic polynomial is

$$(R^2 + 4)R^2 = R^4 + 4R^2,$$

corresponding to the linear differential equation of fourth order and of constant coefficients

$$\frac{d^4x}{dt^4} + 4\frac{d^2x}{dt^2} = q(t).$$

Since  $x = t^2$  is a solution of the inhomogeneous equation, we must have

$$q(t) = \frac{d^4x}{dt^4} + 4\frac{d^2x}{dt^2} = 8,$$

and the equation becomes

$$\frac{d^4x}{dt^4} + 4\frac{d^2x}{dt^2} = 8.$$

**Example 2.8** Find the complete solution of the differential equation

$$\frac{d^3x}{dt^3} + 3\frac{d^2x}{dt^2} + 3\frac{dx}{dt} + x = e^t \cos 2t, \quad t \in \mathbb{R}.$$

**A.** Linear inhomogeneous differential equation of third order and of constant coefficients. This example is almost the same as Example 2.4, with the exception here that we also shall find the complete solution.

**D.** Find the roots of the characteristic polynomial. Then write the solution of the homogeneous equation. Finally, guess a complex solution in the form  $c \cdot e^{(1+2i)t}$ , and then take the real part.

**I.** The characteristic polynomial  $R^3 + 3R^2 + 3R + 1 = (R + 1)^3$  has the treble root  $R = -1$ , hence the complete solution of the homogeneous equation is

$$c_1e^{-t} + c_2te^{-t} + c_3t^2e^{-t}.$$

If we put  $x = c \cdot e^{(1+2i)t}$  into the left hand side of the equation, we get

$$\begin{aligned} \frac{d^3x}{dt^3} + 3\frac{d^2x}{dt^2} + 3\frac{dx}{dt} + x &= c\{1 + (1 + 2i)\}^3 e^{(1+2i)t} = 8c(1 + i)^3 e^{(1+2i)t} \\ &= 16c(-1 + i)e^{(1+2i)t}, \end{aligned}$$

which is equal to  $e^{(1+2i)t}$  for

$$c = \frac{1}{16(-1 + i)} = -\frac{1 + i}{32}.$$

Thus a particular solution is given by

$$x = \operatorname{Re} \left\{ -\frac{1 + i}{32} e^{(1+2i)t} \right\} = \frac{1}{32} e^t \{\sin 2t - \cos 2t\},$$

and the complete solution is

$$x = \frac{1}{32} e^t \sin 2t - \frac{1}{32} e^t \cos 2t + c_1e^{-t} + c_2te^{-t} + c_3t^2e^{-t}, \quad t \in \mathbb{R},$$

where  $c_1, c_2, c_3 \in \mathbb{R}$  are arbitrary constants.

**Example 2.9** Find the complete solution of the differential equation

$$\frac{d^5 x}{dt^5} + 4 \frac{d^4 x}{dt^4} = e^t + 3 \sin 2t + t, \quad t \in \mathbb{R}.$$

- A.** Linear inhomogeneous differential equation of fifth order and of constant coefficients.
- D.** Find the roots of the characteristic polynomial and set up the solution of the homogeneous equation. Then guess systematically, where we note that one of the terms on the right hand side is already a solution of the homogeneous equation.
- I.** The characteristic polynomial  $R^5 + 4R^4 = (R + 4)R^4$  has the simple root  $R = -4$  and the fourfold root  $R = 0$ . Hence the homogeneous equation has the complete solution

$$c_1 + c_2 t + c_3 t^2 + c_4 t^3 + c_5 e^{-4t}, \quad t \in \mathbb{R},$$

where  $c_1, c_2, c_3, c_4, c_5 \in \mathbb{R}$  are arbitrary constants.

If we put  $x = c \cdot e^{2it}$  into the left hand side of the equation, we get

$$\frac{d^5 x}{dt^5} + 4 \frac{d^4 x}{dt^4} = c \{(2i)^5 + (2i)^4\} e^{2it} = 2^4 c \cdot (2i + 1) e^{2it},$$

which is equal to  $3e^{2it}$  for  $c = \frac{3}{16} \cdot \frac{1}{1 + 2i} = \frac{3}{80} (1 - 2i)$ . Since  $3 \sin 2t = \text{Im}\{3e^{2it}\}$ , we obtain the result  $3 \sin 2t$ , when we choose

$$x = \text{Im} \left\{ \frac{3}{80} (1 - 2i) e^{2it} \right\} = \frac{3}{80} \{\sin 2t - 2 \cos 2t\}.$$

If we put  $x = 1, t, t^2, t^3$  into the left hand side of the equation, we of course get 0. If we instead put  $x = c \cdot t^4$ , then we can expect to get a constant, and if we put  $x = c \cdot t^5$ , we can expect to get a polynomial of first degree. Therefore, our guess is

$$x = at^5 + bt^4.$$

Then by insertion

$$\frac{d^4 x}{dt^4} = 5 \cdot 4 \cdot 3 \cdot 2 at + 4 \cdot 3 \cdot 2 \cdot 1 b = 120at + 24b$$

and

$$\frac{d^5 x}{dt^5} = 120a,$$

thus

$$\frac{d^5 x}{dt^5} + 4 \frac{d^4 x}{dt^4} = 120a + 480at + 96b = 480at + (120a + 96b).$$

This is equal to  $t$ , if  $a = \frac{1}{480}$  and

$$120a + 96b = \frac{1}{4} + 96b = 0, \quad \text{i.e.} \quad b = -\frac{1}{384}.$$



The searched solution is

$$x = \frac{1}{480} t^5 - \frac{1}{384} t^4.$$

Finally, the complete solution of the differential equation is

$$\frac{1}{480} t^5 - \frac{1}{384} t^4 + \frac{3}{80} \sin 2t - \frac{3}{40} \cos 2t + \frac{1}{5} e^t + c_1 + c_2 t + c_3 t^2 + c_4 t^3 + c_4 e^{-4t}, \quad t \in \mathbb{R},$$

where  $c_1, c_2, c_3, c_4, c_5 \in \mathbb{R}$  are arbitrary constants.

**Example 2.10** Consider a differential equation

$$\frac{d^4 x}{dt^4} - x = \sin(\alpha t), \quad t \in \mathbb{R},$$

where  $\alpha$  is a real number. Find the values of  $\alpha$ , for which the differential equation has a solution of the form

$$x = a \cos(\alpha t) + b \sin(\alpha t).$$

**A.** Linear inhomogeneous differential equation of fourth order and of constant coefficients. Find the constant  $\alpha$ , such that a given function is a solution.

**D.** Put  $x = c \cdot e^{i\alpha t}$  and see when we get a solution. Although it is not required, we shall nevertheless find the complete solution, just for the practice.

**I.** If  $x = c \cdot e^{i\alpha t}$  is put into the left hand side of the equation, we get

$$\frac{d^4 x}{dt^4} - x = c \{(i\alpha)^4 - 1\} e^{i\alpha t} = c (\alpha^4 - 1) e^{i\alpha t}.$$

When  $\alpha \neq \pm 1$ , then  $\alpha^4 - 1 \neq 0$ . Thus, if we choose  $c = \frac{1}{\alpha^4 - 1}$ , then we get the result  $e^{i\alpha t}$ . Corresponding to this the solution becomes

$$x = \frac{1}{\alpha^4 - 1} \sin \alpha t, \quad \alpha \neq \pm 1.$$

When  $\alpha = \pm 1$ , the right hand side  $\sin \alpha t$  is also a solution of the homogeneous equation, hence a solution, which is independent of the first one, must contain the additional factor  $t$ , so it cannot be of the desired structure.

**REMARK.** Complete solution. The characteristic polynomial

$$R^4 - 1 = (R^2 - 1)(R^2 + 1) = (R - 1)(R + 1)(R^2 + 1)$$

has the four simple roots  $\pm 1$  and  $\pm i$ . Hence, if  $\alpha \neq \pm 1$ , the complete solution is

$$x = \frac{1}{\alpha^4 - 1} \sin \alpha t + c_1 e^t + c_2 e^{-t} + c_3 \cos t + c_4 \sin t, \quad t \in \mathbb{R},$$

where  $c_1, c_2, c_3, c_4 \in \mathbb{R}$  are arbitrary constants.

**Example 2.11** Find the complete solution of the differential equation

$$\frac{d^4 x}{dt^4} + x = \cos t + 2 \cos 2t, \quad t \in \mathbb{R}.$$

- A. Linear inhomogeneous differential equation of fourth order and of constant coefficients.
- D. Find the roots of the characteristic polynomial; set up the solution of the homogeneous equation; finally, guess systematically a particular solution.
- I. The characteristic polynomial  $R^4 + 1$  has the four simple roots

$$\frac{1}{\sqrt{2}}(\pm 1 \pm i),$$

(all four combinations of signs). The complete solution of the homogeneous equation is

$$\begin{aligned} c_1 \exp\left(\frac{1}{\sqrt{2}}t\right) \cos\left(\frac{1}{\sqrt{2}}t\right) + c_2 \exp\left(\frac{1}{\sqrt{2}}t\right) \sin\left(\frac{1}{\sqrt{2}}t\right) \\ + c_3 \exp\left(-\frac{1}{\sqrt{2}}t\right) \cos\left(\frac{1}{\sqrt{2}}t\right) + c_4 \exp\left(-\frac{1}{\sqrt{2}}t\right) \sin\left(\frac{1}{\sqrt{2}}t\right), \\ c_1, c_2, c_3, c_4 \in \mathbb{R}, \quad t \in \mathbb{R}. \end{aligned}$$



**Brain power**

By 2020, wind could provide one-tenth of our planet's electricity needs. Already today, SKF's innovative know-how is crucial to running a large proportion of the world's wind turbines.

Up to 25 % of the generating costs relate to maintenance. These can be reduced dramatically thanks to our systems for on-line condition monitoring and automatic lubrication. We help make it more economical to create cleaner, cheaper energy out of thin air.

By sharing our experience, expertise, and creativity, industries can boost performance beyond expectations.

Therefore we need the best employees who can meet this challenge!

The Power of Knowledge Engineering

Plug into The Power of Knowledge Engineering.  
Visit us at [www.skf.com/knowledge](http://www.skf.com/knowledge)

**SKF**



If we put  $x = c \cdot \cos t$  into the left hand side of the equation. we get

$$\frac{d^4 x}{dt^4} + x = 2c \cdot \cos t,$$

which is equal to  $\cos t$  for  $c = \frac{1}{2}$ , so  $x = \frac{1}{2} \cos t$  gives the result  $\cos t$ .

If we put  $x = c \cdot \cos 2t$  into the left hand side of the equation, we get

$$\frac{d^4 x}{dt^4} + x = c(2^4 + 1) \cos 2t = 17c \cdot \cos 2t,$$

which is equal to  $2 \cos 2t$  for  $c = \frac{2}{17}$ .

When we put all things together we get the complete solution

$$\begin{aligned} & \frac{1}{2} \cos t + \frac{2}{17} \cos 2t \\ & + c_1 \exp\left(\frac{1}{\sqrt{2}} t\right) \cos\left(\frac{1}{\sqrt{2}} t\right) + c_2 \exp\left(\frac{1}{\sqrt{2}} t\right) \sin\left(\frac{1}{\sqrt{2}} t\right) \\ & + c_3 \exp\left(-\frac{1}{\sqrt{2}} t\right) \cos\left(\frac{1}{\sqrt{2}} t\right) + c_4 \exp\left(-\frac{1}{\sqrt{2}} t\right) \sin\left(\frac{1}{\sqrt{2}} t\right), \\ & c_1, c_2, c_3, c_4 \in \mathbb{R}, \quad t \in \mathbb{R}. \end{aligned}$$

**Example 2.12** Consider the differential equation

$$\frac{d^n x}{dt^n} + a_{n-1} \frac{d^{n-1} x}{dt^{n-1}} + \cdots + a_1 \frac{dx}{dt} + a_0 x = q(t), \quad t \in \mathbb{R}.$$

Find the condition for that any two solutions  $\varphi(t)$  and  $\psi(t)$ ,

$$\varphi(t) - \psi(t) \rightarrow 0 \quad \text{for } t \rightarrow \infty.$$

- A.** Find a condition for that all solutions of the homogeneous equation tend to 0 for  $t \rightarrow +\infty$ .
- D.** Find the roots of the characteristic polynomial.
- I.** By a complex factorization (*the fundamental theorem of algebra*) we get the characteristic polynomial

$$R^n + a_{n-1} R^{n-1} + \cdots + a_1 R + a_0 = (R - r_1)(R - r_2) \cdots (R - r_n).$$

If  $r \in \{r_1, \dots, r_n\}$  is a simple root,  $r = r' + ir''$ , then a solution of the homogeneous equation is

$$e^{rt} = e^{r't} e^{ir''t} = e^{r't} \{\cos r''t + i \sin r''t\}.$$

Now  $|e^{ir''t}| = 1$ , so the condition is  $e^{r't} \rightarrow 0$  for  $t \rightarrow +\infty$ , i.e.  $\operatorname{Re} r < 0$ .

If  $r$  is a multiple root of multiplicity  $k > 1$ , then we must at least have  $\operatorname{Re} r < 0$ . Since the solution corresponding to  $r$  is a linear combination of

$$e^{rt}, te^{rt}, \dots, t^{k-1}e^{rt},$$

and since the exponential dominates the power functions, this condition is also sufficient.

The condition is that every root in the characteristic polynomial has negative real part. (This condition is both necessary and sufficient).

**Example 2.13** Consider the differential equation

$$\frac{d^4x}{dt^4} + 5\frac{d^3x}{dt^3} + 13\frac{d^2x}{dt^2} + 19\frac{dx}{dt} + 10x = \sin 2t, \quad t \in \mathbb{R}.$$

Prove that there exists precisely one solution which is periodic of period  $\pi$ , and find this solution.

- A.** Linear inhomogeneous differential equation of fourth order and of constant coefficients. Find a periodic solution.
- D.** Find the roots of the characteristic polynomial. Prove that no solution of the homogeneous equation is periodic. Finally, find a solution by the complex method.
- I.** The characteristic polynomial

$$R^4 + 5R^3 + 13R^2 + 19R + 10$$

is positive for  $R \geq 0$ , so the only possible rationale roots can only be found among the numbers  $-1, -2, -5, -10$ . By trial and error,

$$\begin{aligned} R = -1: & \quad R^4 + 5R^3 + 13R^2 + 19R + 10 = 1 - 5 + 13 - 19 + 10 = 0, \\ R = -2: & \quad R^4 + 5R^3 + 13R^2 + 19R + 10 = 16 - 40 + 52 - 38 + 10 = 0, \end{aligned}$$

proving the  $R = -1$  and  $R = -2$  are roots. Then

$$(R + 1)(R + 2) = R^2 + 3R + 2$$

is a divisor in the characteristic polynomial. By division we get

$$R^4 + 5R^3 + 13R^2 + 19R + 10 = (R + 1)(R + 2)(R^2 + 2R + 5),$$

and we see that all roots are

$$R = -1, \quad R = -2, \quad R = -1 \pm 2i.$$

These are all simple. Due to the exponential factor, none of the corresponding solutions of the homogeneous equation (linear combinations of

$$e^{-t}, \quad e^{-2t}, \quad e^{-t} \cos 2t, \quad e^{-t} \sin 2t,)$$

can be periodic.

There must exist a solution of the form  $\text{Im}\{c \cdot e^{2it}\}$ . Clearly, such a solution is periodic of period  $\pi$ .

If we put  $x = c \cdot e^{2it}$  into the left hand side of the equation, we get

$$\begin{aligned} \frac{d^4 x}{dt^4} + 5 \frac{d^3 x}{dt^3} + 13 \frac{d^2 x}{dt^2} + 19 \frac{dx}{dt} + 10x \\ = \{(2i)^4 + 5(2i)^3 + 13(2i)^2 + 19 \cdot 2i + 10\} e^{2it} \\ = c\{16 - 40i - 52 + 38i + 10\}e^{2it} = c \cdot 2(-13 - i)e^{2it}, \end{aligned}$$

which is equal to  $e^{2it}$  for

$$c = -\frac{1}{2} \cdot \frac{1}{13+i} = -\frac{1}{2} \cdot \frac{1}{170} (13-i) = -\frac{1}{340} (13-i) = \frac{1}{340} (-13+i).$$

Thus, the periodic solution is given by

$$x_0(t) = \text{Im} \left\{ \frac{1}{340} (-13+i)e^{2it} \right\} = \frac{1}{340} \cos 2t - \frac{13}{340} \sin 2t.$$

**Example 2.14** Find the complete solution of the differential equation

$$\frac{d^4 x}{dt^4} - 2 \frac{d^3 x}{dt^3} - 2 \frac{d^2 x}{dt^2} + 8t = t^4 - 3t^2 - 5t + 2, \quad t \in \mathbb{R}.$$

- A.** Linear inhomogeneous differential equation of order 4 and of constant coefficients.
- D.** Find the roots of the characteristic polynomial; then write down the solution of the homogeneous equation; finally, guess a particular solution.
- I.** The possible rational roots of the characteristic polynomial

$$R^4 - 2R^3 - 2R^2 + 8$$

are  $R = \pm 1, \pm 2, \pm 4$  and  $\pm 8$ .

Clearly,  $R = \pm 1$  is not a root, because  $R^4 - 2R^3 - 2R^2$  is odd for  $R = \pm 1$ . Furthermore, 32 is a divisor in  $R^4 - 2R^3 - 2R^2$ , when  $R = \pm 4$  or  $R = \pm 8$ , so we can also exclude these possibilities. Therefore, it remains only  $R = \pm 2$ . By a calculation

$$R = 2: \quad R^4 - 2R^3 - 2R^2 + 8 = 16 - 16 - 8 + 8 = 0,$$

proving that  $R = 2$  is a root. Then by a division by a polynomial we get the factorization

$$R^4 - 2R^3 - 2R^2 + 8 = (R-2)(R^3 - 2R - 4) = (R-2)^2(R^2 + 2R + 2),$$

and we see that the roots are  $R = 2$  (double root) and the two simple roots  $R = -1 \pm i$ .

Hence, the complete solution of the homogeneous equation is

$$c_1 e^{2t} + c_2 t e^{2t} + c_3 e^{-t} \cos t + c_4 e^{-t} \sin t, \quad t \in \mathbb{R},$$

where  $c_1, c_2, c_3, c_4 \in \mathbb{R}$  are arbitrary constants.

Since none of these terms occurs in the right hand side of the equation, we guess a particular solution of the form of a polynomial of fourth degree. Then we get the calculations:

$$\begin{aligned} x &= at^4 + bt^3 + ct^2 + dt + e, \\ \frac{dx}{dt} &= 4at^3 + 3bt + 2ct + d, \\ \frac{d^2x}{dt^2} &= 12at^2 + 6bt + 2c, \\ \frac{d^3x}{dt^3} &= 24at + 6b, \\ \frac{d^4x}{dt^4} &= 24a. \end{aligned}$$

By insertion,

$$\begin{aligned} \frac{d^4x}{dt^4} - 2 \frac{d^3x}{dt^3} - 2 \frac{d^2x}{dt^2} + 8x &= 8at^4 + 8bt^3 + 8ct^2 + 8dt + 8e - 24at^2 - 12bt - 4c - 48at - 12b + 24a \\ &= 8at^4 + 8bt^3 + (8c - 24a)t^2 + (8d - 12b - 48a)t + (8e - 4c - 12b + 24a). \end{aligned}$$



# What do you want to do?

No matter what you want out of your future career, an employer with a broad range of operations in a load of countries will always be the ticket. Working within the Volvo Group means more than 100,000 friends and colleagues in more than 185 countries all over the world. We offer graduates great career opportunities – check out the Career section at our web site [www.volvogroup.com](http://www.volvogroup.com). We look forward to getting to know you!

**VOLVO**  
AB Volvo (publ)  
[www.volvogroup.com](http://www.volvogroup.com)

VOLVO TRUCKS | RENAULT TRUCKS | MACK TRUCKS | VOLVO BUSES | VOLVO CONSTRUCTION EQUIPMENT | VOLVO PENTA | VOLVO AERO | VOLVO IT  
VOLVO FINANCIAL SERVICES | VOLVO 3P | VOLVO POWERTRAIN | VOLVO PARTS | VOLVO TECHNOLOGY | VOLVO LOGISTICS | BUSINESS AREA ASIA



This is equal to  $t^4 - 3t^2 - 5t + 2$ , if

$$8a = 1, \quad 8b = 0, \quad 8c - 24 = -3,$$

$$8d - 12b - 48a = -5, \quad 8e - 4c - 12b + 24a = 2,$$

hence

$$a = \frac{1}{8}, \quad b = 0, \quad c = 0,$$

$$8d = 12b + 48a - 5 = 1, \quad \text{dvs.} \quad d = \frac{1}{8},$$

and

$$8e = 4c + 12b - 24a + 2 = -1, \quad \text{dvs.} \quad e = -\frac{1}{8}.$$

Thus, the complete solution is

$$x = \frac{1}{8}t^4 + \frac{1}{8}t - \frac{1}{8} + c_1e^{2t} + c_2te^{2t} + c_3e^{-t}\cos t + c_4e^{-t}\sin t,$$

$$t \in \mathbb{R}, \quad c_1, \dots, c_4 \in \mathbb{R}.$$

**Example 2.15** Consider a differential equation of order  $n$ ,

$$(16) \quad \frac{d^n x}{dt^n} + a_{n-1} \frac{d^{n-1} x}{dt^{n-1}} + \dots + a_1 \frac{dx}{dt} + a_0 x = \cos \omega t, \quad t \in \mathbb{R},$$

with its corresponding characteristic equation

$$P(R) = R^n + a_{n-1}R^{n-1} + \dots + a_1R + a_0 = 0.$$

Prove that

$$x = \operatorname{Re} \left( \frac{e^{i\omega t}}{P(i\omega)} \right)$$

is a solution of (16), if  $P(i\omega) \neq 0$ .

**A.** Linear inhomogeneous differential equation of order  $n$  and of constant coefficients.

**D.** Solve the equation by the complex method.

**I.** Assume that  $P(i\omega) \neq 0$ .

If we put  $x = c \cdot e^{i\omega t}$ , we get

$$\frac{d^k x}{dt^k} = c(i\omega)^k e^{i\omega t},$$

so

$$\begin{aligned} \frac{d^n x}{dt^n} + a_{n-1} \frac{d^{n-1} x}{dt^{n-1}} + \dots + a_1 \frac{dx}{dt} + a_0 x \\ &= c \left\{ (i\omega)^n + a_{n-1}(i\omega)^{n-1} + \dots + a_1(i\omega) + a_0 \right\} e^{i\omega t} \\ &= c \cdot P(i\omega) e^{i\omega t}. \end{aligned}$$

This is equal to  $e^{i\omega t}$  for  $c = \frac{1}{P(i\omega)}$ , hence a solution of (16) is given by

$$x = \operatorname{Re} \left( \frac{e^{i\omega t}}{P(i\omega)} \right).$$

**Example 2.16** Given the polynomial

$$P(z) = z^4 + 6z^2 + 25, \quad z \in \mathbb{C}.$$

- 1) Find all complex roots of  $P(z)$ .
- 2) Calculate the complex number  $P(1+i)$ .
- 3) Find the complete solution of the differential equation

$$\frac{d^4 x}{dt^4} + 6 \frac{d^2 x}{dt^2} + 25x = e^t \cos t, \quad t \in \mathbb{R}.$$

- A.** Roots of a polynomial of fourth degree. Computation of a complex number. A linear inhomogeneous differential equation of second order and of constant coefficient.
- D.** The polynomial of degree four is a polynomial of degree two in the new variable  $w = z^2$ .

The characteristic polynomial is equal to the given polynomial. The roots are given in (1). From  $e^t \cos t = \operatorname{Re}\{e^{(1+i)t}\}$  follows that (2) can be applied when we shall find a particular solution of the inhomogeneous equation-

- I.** 1) When  $w = z^2$  we get

$$P(z) = z^4 + 6z^2 + 25 = w^2 + 6w + 25 = (w+3)^2 + 16.$$

Thus, the roots are

$$w = z^2 = \begin{cases} -3 + 4i = 1 + 2 \cdot 2i - 2^2 = (1 + 2i)^2, \\ -3 - 4i = 1 - 2 \cdot 2i - 2^2 = (1 - 2i)^2, \end{cases}$$

so we find the four roots

$$1 + 2i, \quad 1 - 2i, \quad -1 + 2i, \quad -1 - 2i.$$

- 2) By insertion we get

$$P(1+i) = (1+i)^4 + 6(1+i)^2 + 25 = -4 + 12i + 25 = 21 + 12i = 3(7 + 4i).$$

- 3) According to (1) the roots of the characteristic polynomial are

$$1 + 2i, \quad 1 - 2i, \quad -1 + 2i, \quad -1 - 2i.$$

Then the corresponding homogeneous equation has the complete solution

$$c_1 e^t \cos 2t + c_2 e^t \sin 2t + c_3 e^{-t} \cos 2t + c_4 e^{-t} \sin 2t.$$



The corresponding inhomogeneous *complex* equation is of the form

$$\frac{d^4 x}{dt^4} + 6 \frac{d^2 x}{dt^2} + 25x = e^{(1+i)t}, \quad t \in \mathbb{R}.$$

Let us guess on  $x = a e^{(1+i)t}$ . Then by (2),

$$\frac{d^4 x}{dt^4} + 6 \frac{d^2 x}{dt^2} + 25x = P(1+i)a e^{(1+i)t} = 3(7+4i)a e^{(1+i)t}.$$

This is equal to  $e^{(1+i)t}$ , if

$$a = \frac{1}{3} \cdot \frac{1}{7+4i} = \frac{1}{3} \cdot \frac{7-4i}{7^2+4^2} = \frac{1}{195} (7-4i).$$

Hence we obtain a particular solution of the complex equation,

$$x = \frac{1}{195} (7-4i) e^{(1+i)t}.$$

The corresponding solution of the *real* equation is

$$\begin{aligned} x &= \operatorname{Re} \left\{ \frac{1}{195} (7-4i) e^{(1+i)t} \right\} \\ &= \frac{e^t}{195} \operatorname{Re} \{ (7-4i)(\cos t + i \sin t) \} \\ &= \frac{e^t}{195} \{ 7 \cos t + 4 \sin t \}. \end{aligned}$$

The complete solution is

$$\begin{aligned} x &= \frac{7}{195} e^t \cos t + \frac{4}{195} e^t \sin t + c_1 e^t \cos 2t \\ &\quad + c_2 e^t \sin 2t + c_3 e^{-t} \cos 2t + c_4 e^{-t} \sin 2t, \end{aligned}$$

where  $t \in \mathbb{R}$ , and where  $c_1, c_2, c_3, c_4 \in \mathbb{R}$  are arbitrary constants.

**C. TEST.** If

$$x = \frac{7}{195} e^t \cos t + \frac{4}{195} e^t \sin t,$$

then

$$\begin{aligned} \frac{dx}{dt} &= \frac{7+4}{195} e^t \cos t + \frac{-7+4}{195} e^t \sin t \\ &= \frac{11}{195} e^t \cos t - \frac{3}{195} e^t \sin t, \end{aligned}$$

and

$$\begin{aligned} \frac{d^2 x}{dt^2} &= \frac{11-3}{195} e^t \cos t + \frac{-11-3}{195} e^t \sin t \\ &= \frac{8}{195} e^t \cos t - \frac{14}{195} e^t \sin t, \end{aligned}$$

and

$$\begin{aligned}\frac{d^3x}{dt^3} &= \frac{8-14}{195} e^t \cos t + \frac{-8-14}{195} e^t \sin t \\ &= -\frac{6}{195} e^t \cos t - \frac{29}{195} e^t \sin t,\end{aligned}$$

and

$$\begin{aligned}\frac{d^4x}{dt^4} &= \frac{-6-22}{195} e^t \cos t + \frac{6-22}{195} e^t \sin t \\ &= -\frac{28}{195} e^t \cos t - \frac{16}{195} e^t \sin t.\end{aligned}$$

**qaiteye**<sup>®</sup>  
Challenge the way we run

**EXPERIENCE THE POWER OF  
FULL ENGAGEMENT...**

.....

**RUN FASTER.  
RUN LONGER..  
RUN EASIER...**

**READ MORE & PRE-ORDER TODAY  
WWW.GAITEYE.COM**

Finally, by insertion,

$$\begin{aligned}
 & \frac{d^4 x}{dt^4} + 6 \frac{d^2 x}{dt^2} + 25 x \\
 &= -\frac{28}{195} e^t \cos t - \frac{16}{195} e^t \sin t \\
 & \quad + \frac{48}{195} e^t \cos t - \frac{84}{195} e^t \sin t \\
 & \quad + \frac{35}{39} e^t \cos t + \frac{20}{39} e^t \sin t \\
 &= \left( \frac{20}{195} + \frac{35}{39} \right) e^t \cos t + \left( -\frac{100}{195} + \frac{20}{39} \right) e^t \sin t \\
 &= \left( \frac{4}{39} + \frac{35}{39} \right) e^t \cos t + \left( -\frac{20}{39} + \frac{20}{39} \right) e^t \sin t \\
 &= e^t \cos t. \quad \diamond
 \end{aligned}$$

We shall not test the solution of the homogeneous equation.

**Example 2.17** 1) Find the complete solution of the differential equation

$$\frac{d^3 x}{dt^3} - 2 \frac{d^2 x}{dt^2} + 3x = 0, \quad t \in \mathbb{R}.$$

2) Find the complete solution of the differential equation

$$(17) \quad \frac{d^3 x}{dt^3} - 2 \frac{d^2 x}{dt^2} + 3x = 13 \cos t, \quad t \in \mathbb{R}.$$

3) Find all solutions  $x = \varphi(t)$  of (17), for which also  $\varphi(0) = 0$ .

4) Prove that if  $x = \varphi(t)$  is a solution of (17), then  $y = \varphi'(t)$  is a solution of

$$(18) \quad \frac{d^3 y}{dt^3} - 2 \frac{d^2 y}{dt^2} + 3y = -13 \sin t, \quad t \in \mathbb{R}.$$

Do we here have a converse, i.e. if  $y = \psi(t)$  is a solution of (18), and  $\varphi(t)$  is an integral of  $\psi(t)$ , then  $x = \varphi(t)$  is a solution of (17)?

**A.** Linear homogeneous and inhomogeneous differential equation of third order and of constant coefficients.

**D.** Find the roots of the characteristic polynomial and the complete solution of the homogeneous equation. Then guess a particular solution. Finally, differentiate (17).

**I.** 1) The characteristic polynomial

$$\begin{aligned}
 R^3 - 2R^2 + 3 &= (R+1)(R^2 - 3R + 3) \\
 &= (R+1) \left( R - \frac{3+i\sqrt{3}}{2} \right) \left( R - \frac{3-i\sqrt{3}}{2} \right)
 \end{aligned}$$

has the roots

$$-1, \quad \frac{3+i\sqrt{3}}{2}, \quad \frac{3-i\sqrt{3}}{2}.$$

Thus the complete solution of the homogeneous equation is

$$c_1 e^{-t} + c_2 \exp\left(\frac{3}{2}t\right) \cos\left(\frac{\sqrt{3}}{2}t\right) + c_3 \exp\left(\frac{3}{2}t\right) \sin\left(\frac{\sqrt{3}}{2}t\right), \quad t \in \mathbb{R},$$

where  $c_1, c_2, c_3 \in \mathbb{R}$  are arbitrary constants.

The corresponding complex equation is

$$\frac{d^3x}{dt^3} - 2 \frac{d^2x}{dt^2} + 3x = 13e^{it}.$$

If we guess on  $x = a e^{it}$ , then we get by insertion,

$$\frac{d^3x}{dt^3} - 2 \frac{d^2x}{dt^2} + 3x = a(i^3 - 2i^2 + 3)e^{it} = a(5 - i)e^{it},$$

which is equal to  $13e^{it}$  for

$$a = \frac{13}{5-i} = \frac{13(5+i)}{5^2+1} = \frac{5+i}{2}.$$

Thus, a particular solution of (17) is

$$x = \operatorname{Re} \left\{ \frac{5+i}{2} (\cos t + i \sin t) \right\} = \frac{1}{2} \{5 \cos t - \sin t\}.$$

The complete solution of (17) is

$$\begin{aligned} \varphi(t) &= \frac{5}{2} \cos t - \frac{1}{2} \sin t + c_1 e^{-t} \\ &\quad + c_2 \exp\left(\frac{3}{2}t\right) \cos\left(\frac{\sqrt{3}}{2}t\right) + c_3 \exp\left(\frac{3}{2}t\right) \sin\left(\frac{\sqrt{3}}{2}t\right), \end{aligned}$$

where  $t \in \mathbb{R}$ , and where  $c_1, c_2, c_3 \in \mathbb{R}$  are arbitrary constants.

If we put  $t = 0$ , we get

$$\varphi(0) = \frac{5}{2} + c_1 + c_2 = 0, \quad \text{hence } c_1 = -\frac{5}{2} - c_2.$$

All solutions  $\varphi(t)$ , for which  $\varphi(0) = 0$ , are then

$$\begin{aligned} \varphi(t) &= \frac{5}{2} \cos t - \frac{1}{2} \sin t - \left(\frac{5}{2} + c_2\right) e^{-t} \\ &= c_2 \exp\left(\frac{3}{2}t\right) \cos\left(\frac{\sqrt{3}}{2}t\right) + c_3 \exp\left(\frac{3}{2}t\right) \sin\left(\frac{\sqrt{3}}{2}t\right), \end{aligned}$$

where  $t \in \mathbb{R}$ , and where  $c_2, c_3 \in \mathbb{R}$  are arbitrary constants.

Then by differentiating (17),

$$\frac{d^4x}{dt^4} - 2 \frac{d^3x}{dt^3} + 3 \frac{dx}{dt} = \frac{d^3y}{dt^3} - 2 \frac{d^2y}{dt^2} + 3y = -13 \sin t.$$

Use the same reasoning on the equation

$$(19) \quad \frac{d^3x}{dt^3} - 2 \frac{d^2x}{dt^2} + 3x = 13 \cos t + c, \quad c \text{ arbitrary constant,}$$

where  $y = \frac{dx}{dt}$  of course also is a solution of (18). Therefore, it is *not* possible to conclude that an integral of a solution  $y$  of (18) is also a solution of (17).

**Example 2.18** Find the complete solution of the differential equation

$$\frac{d^3x}{dt^3} + 8x = \cos 3t, \quad t \in \mathbb{R}.$$

**A.** Linear inhomogeneous differential equation of third order and of constant coefficients. Cf. also Example 2.19.

**D.** Solve the characteristic equation and guess a particular solution.

**I.** The characteristic polynomial

$$\begin{aligned} R^3 + 8 &= (R + 2)(R^2 - 2R + 4) \\ &= (R + 2)(R - \{1 + i\sqrt{3}\})(R - \{1 - i\sqrt{3}\}) \end{aligned}$$

has the roots  $-2$ ,  $1 + i\sqrt{3}$  and  $1 - i\sqrt{3}$ , so the complete solution of the homogeneous equation is

$$c_1 e^{-2t} + c_2 e^t \cos(\sqrt{3}t) + c_3 e^t \sin(\sqrt{3}t), \quad t \in \mathbb{R},$$

where  $c_1, c_2, c_3 \in \mathbb{R}$  are arbitrary constants.

The corresponding complex equation is

$$\frac{d^3x}{dt^3} + 8x = e^{3it}.$$

If we put  $x = a e^{3it}$  into the left hand side of the equation, we get

$$\frac{d^3x}{dt^3} + 8x = a \{(3i)^3 + 8\} e^{3it} = 8\{8 - 27i\} e^{3it},$$

which is equal to  $e^{3it}$ , when

$$a = \frac{1}{8 - 27i} = \frac{8 + 27i}{8^2 + 27^2} = \frac{1}{793} \{8 + 27i\}.$$

Thus, a solution of the corresponding real equation is

$$\begin{aligned} x &= \operatorname{Re} \left\{ \frac{1}{793} (8 + 27i)(\cos 3t + i \sin 3t) \right\} \\ &= \frac{1}{793} \{8 \cos 3t - 27 \sin 3t\}. \end{aligned}$$

The complete solution of the original equation is now

$$x = \frac{1}{793} \{8 \cos 3t - 27 \sin 3t\} + c_1 e^{-2t} + c_2 e^t \cos(\sqrt{3}t) + c_3 e^t \sin(\sqrt{3}t), \quad t \in \mathbb{R},$$

where  $c_1, c_2, c_3 \in \mathbb{R}$  are arbitrary constants.

**Example 2.19** 1) Find the complete solution of the differential equation

$$\frac{d^3 x}{dt^3} + 8x = \cos 3t, \quad t \in \mathbb{R}.$$

2) How many solutions  $x = \varphi(t)$  of the differential do also satisfy  $\varphi(0) = 0$  and  $\varphi'(0) = 1$ ?

**A.** Linear inhomogeneous differential equation of third order and of constant coefficients. The first question is the same as the first question in Example 2.18.

**D.** Solve the characteristic equation and then guess a particular solution.

This e-book  
is made with  
**SetaPDF**



**SETASIGN**



PDF components for **PHP** developers

[www.setasign.com](http://www.setasign.com)



I. 1) The characteristic polynomial

$$\begin{aligned} R^3 + 8 &= (R + 2)(R^2 - 2R + 4) \\ &= (R + 2)(R - \{1 + i\sqrt{3}\})(R - \{1 - i\sqrt{3}\}) \end{aligned}$$

has the roots  $-2$ ,  $1 + i\sqrt{3}$  and  $1 - i\sqrt{3}$ , so the complete solution of the homogeneous equation is

$$c_1 e^{-2t} + c_2 e^t \cos(\sqrt{3}t) + c_3 e^t \sin(\sqrt{3}t), \quad t \in \mathbb{R},$$

where  $c_1, c_2, c_3 \in \mathbb{R}$  are arbitrary constants.

The corresponding complex equation is

$$\frac{d^3 x}{dt^3} + 8x = e^{3it}.$$

If we put  $x = a e^{3it}$  into the left hand side of the equation, we get

$$\frac{d^3 x}{dt^3} + 8x = a \{(3i)^3 + 8\} e^{3it} = 8\{8 - 27i\} e^{3it},$$

which is equal to  $e^{3it}$  for

$$a = \frac{1}{8 - 27i} = \frac{8 + 27i}{8^2 + 27^2} = \frac{1}{793} \{8 + 27i\}.$$

Then a solution of the corresponding real equation is

$$\begin{aligned} x &= \operatorname{Re} \left\{ \frac{1}{793} (8 + 27i)(\cos 3t + i \sin 3t) \right\} \\ &= \frac{1}{793} \{8 \cos 3t - 27 \sin 3t\}. \end{aligned}$$

The complete solution of the original equation is

$$\begin{aligned} x &= \frac{1}{793} \{8 \cos 3t - 27 \sin 3t\} + c_1 e^{-2t} \\ &\quad + c_2 e^t \cos(\sqrt{3}t) + c_3 e^t \sin(\sqrt{3}t), \quad t \in \mathbb{R}, \end{aligned}$$

where  $c_1, c_2, c_3 \in \mathbb{R}$  are arbitrary constants.

2) Since we have two constraints and three arbitrary constants, we must have an infinity of solutions. Now,

$$x = \frac{1}{793} \{8 \cos 3t - 27 \sin 3t\} + c_1 e^{-2t} + c_2 e^t \cos(\sqrt{3}t) + c_3 e^t \sin(\sqrt{3}t),$$

so

$$\begin{aligned} \frac{dx}{dt} &= \frac{1}{793} \{-81 \cos 3t - 24 \sin 3t\} - 2c_1 e^{-2t} \\ &\quad + (c_2 + c_3 \sqrt{3}) e^t \cos(\sqrt{3}t) + (-c_2 \sqrt{3} + c_3) e^t \sin(\sqrt{3}t). \end{aligned}$$

If we put  $t = 0$ , then

$$\varphi(0) = 0 = \frac{8}{793} + c_1 + c_2, \quad \varphi'(0) = 1 = -\frac{81}{793} - 2c_1 + c_2 + c_3 \sqrt{3},$$

hence  $c_1 = -\frac{8}{793} - c_2$  and

$$1 = -\frac{81}{793} - 2c_1 + c_2 + c_3 = -\frac{81}{793} + \frac{16}{793} + 3c_2 + c_3,$$

so

$$c_3 = 1 + \frac{81}{793} - \frac{16}{793} - 3c_2 = 1 + \frac{65}{13 \cdot 61} - 3c_2 = 1 + \frac{5}{61} - 3c_2 = \frac{66}{61} - 3c_2.$$

The set of solutions is given by

$$\begin{aligned} x = & \frac{1}{793} \{8 \cos 3t - 27 \sin 3t\} - \left( \frac{8}{793} + c_2 \right) e^{-2t} \\ & + c_2 e^{-2t} + c_2 e^t \cos(\sqrt{3}t) + \left( \frac{66}{61} - 3c_2 \right) e^t \sin(\sqrt{3}t), \quad t \in \mathbb{R}, \end{aligned}$$

where  $c_2 \in \mathbb{R}$  is an arbitrary constant.

**Example 2.20** Find the complete real solution of the differential equation

$$\frac{d^4 x}{dt^4} + 8 \frac{d^2 x}{dt^2} + 16x = 0, \quad t \in \mathbb{R}.$$

- A. Linear homogeneous differential equation of fourth order and of constant coefficients. Cf. also Example 2.21.
- D. Find the roots of the characteristic polynomial.
- I. The characteristic polynomial  $R^4 + 8R^2 + 16 = (R^2 + 4)^2$  has the two complex conjugated double roots  $\pm 2i$ . Then the complete solution is

$$x = c_1 \cos 2t + c_2 \sin 2t + c_3 t \cos 2t + c_4 t \sin 2t, \quad t \in \mathbb{R},$$

where  $c_1, c_2, c_3, c_4 \in \mathbb{R}$  are arbitrary constants.

**Example 2.21** Find the complete real solution of the differential equation

$$\frac{d^4 x}{dt^4} + 8 \frac{d^2 x}{dt^2} + 16x = e^t \sin t.$$

- A. Linear inhomogeneous differential equation of fourth order and of constant coefficients. Cf. also Example 2.20.
- D. Find the roots of the characteristic polynomial. Guess on a complex solution of the type  $x = c \cdot e^{(1+i)t}$ , because

$$\operatorname{Im} e^{(1+i)t} = e^t \sin t.$$



- I. The characteristic polynomial  $R^4 + 8R^2 + 16 = (R^2 + 4)^2$  has the two complex conjugated double roots  $\pm 2i$ . The corresponding homogeneous equation has the complete solution

$$c_1 \cos 2t + c_2 \sin 2t + c_3 t \cos 2t + c_4 t \sin 2t, \quad t \in \mathbb{R},$$

where  $c_1, c_2, c_3, c_4 \in \mathbb{R}$  are arbitrary constants.

If we put  $x = c e^{(1+i)t}$  into the left hand side of the equation, and let  $R = 1 + i$ , we get

$$\begin{aligned} c(R^2 + 4)^2 e^{(1+i)t} &= c \{(1+i)^2 + 4\}^2 e^{(1+i)t} = c(2i+4)^2 e^{(1+i)t} \\ &= 4c(2+i)^2 e^{(1+i)t} = 4c(3+4i)e^{(1+i)t}, \end{aligned}$$

which is equal to  $e^{(1+i)t}$  for

$$c = \frac{1}{4(3+4i)} = \frac{3-4i}{4 \cdot (9+16)} = \frac{3-4i}{100}.$$

Then a particular solution is

$$x = \operatorname{Im} \left\{ \frac{3-4i}{100} e^{(1+i)t} \right\} = \frac{1}{100} e^t \{3 \sin t - 4 \cos t\}.$$

Finally, we get the complete solution

$$\begin{aligned} x &= \frac{1}{100} e^t \{3 \sin t - 4 \cos t\} + c_1 \cos 2t + c_2 \sin 2t \\ &\quad + c_3 t \cos 2t + c_4 t \sin 2t, \quad t \in \mathbb{R}, \end{aligned}$$

where  $c_1, c_2, c_3, c_4 \in \mathbb{R}$  are arbitrary constants.

**Example 2.22** Find the complete solution of the differential equation

$$\frac{d^3 x}{dt^3} - \frac{d^2 x}{dt^2} - \frac{dx}{dt} + x = \cos t, \quad t \in \mathbb{R}.$$

- A. Linear inhomogeneous differential equation of third order and of constant coefficients.  
 D. Analyze the characteristic polynomial. Guess a particular solution.  
 I. The characteristic polynomial

$$R^3 - R^2 - R + 1 = (R-1)(R^2-1) = (R-1)^2(R+1)$$

has the simple root  $R = -1$  and the double root  $R = 1$ . The homogeneous equation has the solution

$$c_1 e^{-t} + c_2 e^t + c_3 t e^t, \quad c_1, c_2, c_3 \in \mathbb{R}, \quad t \in \mathbb{R}.$$

If we guess the solution  $x = c \cdot e^{it}$ , we get

$$\frac{d^3 x}{dt^3} - \frac{d^2 x}{dt^2} - \frac{dx}{dt} + x = c \{i^3 - i^2 - i + 1\} e^{it} = c \{2 - 2i\} e^{it}.$$

This is equal to  $e^{it}$  for  $c = \frac{1}{2-2i} = \frac{1+i}{4}$ . Then a particular solution is given by

$$\operatorname{Re} \left\{ \frac{1}{4} (1+i) e^{it} \right\} = \frac{1}{4} \{ \cos t - \sin t \}.$$

Finally, the complete solution is

$$x = \frac{1}{4} \{ \cos t - \sin t \} + c_1 e^{-t} + c_2 e^t + c_3 t e^t, \quad t \in \mathbb{R},$$

where  $c_1, c_2, c_3 \in \mathbb{R}$  are arbitrary constants.

**Example 2.23** Find the complete solution of the differential equation

$$\frac{d^3 x}{dt^3} - 4 \frac{d^2 x}{dt^2} + \frac{dx}{dt} - 4x = 8t^2 + 15, \quad t \in \mathbb{R}.$$

- A. Linear inhomogeneous differential equation of third order and of constant coefficients.  
 D. Solve the characteristic equation. Then guess a particular solution.



www.sylvania.com

We do not reinvent  
the wheel we reinvent  
light.

Fascinating lighting offers an infinite spectrum of possibilities: Innovative technologies and new markets provide both opportunities and challenges. An environment in which your expertise is in high demand. Enjoy the supportive working atmosphere within our global group and benefit from international career paths. Implement sustainable ideas in close cooperation with other specialists and contribute to influencing our future. Come and join us in reinventing light every day.

Light is OSRAM

OSRAM  
SYLVANIA

I. The characteristic polynomial

$$R^3 - 4R^2 + R - 4 = (R - 4)(R^2 + 1)$$

has the three simple roots  $R = 4$  and  $R = \pm i$ , so the homogeneous equation has the complete solution

$$c_1 e^{4t} + c_2 \cos t + c_3 \sin t, \quad t \in \mathbb{R}, \quad c_1, c_2, c_3 \in \mathbb{R}.$$

If we then put  $x = at^2 + bt + c$ , we get by insertion

$$\begin{aligned} \frac{d^3x}{dt^3} - 4 \frac{d^2x}{dt^2} + \frac{dx}{dt} - 4x \\ = -4 \cdot 2a + b + 2at - 4at^2 - 4bt - 4c \\ = -4at^2 + (2a - 4b)t - 8a + b - 4c. \end{aligned}$$

This is equal to  $8t^2 + 15$ , when

$$-4a = 8, \quad 2a - 4b = 0, \quad -8a + b - 4c = 15,$$

so  $a = -2$ ,  $b = \frac{1}{2}a = -1$  and

$$c = \frac{1}{4}(-8a + b - 15) = \frac{1}{4}(16 - 1 - 15) = 0.$$

Thus, a particular solution is  $-2t^2 - t$ .

All things considered we obtain the complete solution

$$x = -2t^2 - t + c_1 e^{4t} + c_2 \cos t + c_3 \sin t, \quad t \in \mathbb{R},$$

where  $c_1, c_2, c_3 \in \mathbb{R}$  are arbitrary constants.

**Example 2.24** Find the complete solution of the differential equation

$$\frac{d^3x}{dt^3} + 3 \frac{d^2x}{dt^2} = \sin t, \quad t \in \mathbb{R}.$$

A. Linear inhomogeneous differential equation of third order and of constant coefficients.

D. Find the roots of the characteristic polynomial. Then guess a particular solution.

I. The corresponding characteristic polynomial

$$R^3 + 3R^2 = R^2(R + 3)$$

has the simple root  $R = -3$  and the double root  $R = 0$ , so the corresponding homogeneous equation has the complete solution

$$x = c_1 + c_2 t + c_3 e^{-3t}.$$

We then use the complex method. If we put  $x = a e^{it}$ , we see that

$$\frac{d^3 x}{dt^3} + 3 \frac{d^2 x}{dt^2} = a (i^3 + 3i^2) e^{it} = a(-3 - i)e^{it}.$$

This is equal to  $e^{it}$  for

$$a = -\frac{1}{3+i} = -\frac{3-i}{10} = \frac{1}{10}(-3+i),$$

so a particular solution is

$$\begin{aligned} x_0(t) &= \operatorname{Im} \left\{ \frac{1}{10} (-3+i)(\cos t + i \sin t) \right\} \\ &= \frac{1}{10} \{\cos t - 3 \sin t\}. \end{aligned}$$

Hence, the complete solution is

$$x(t) = \frac{1}{10} \cos t - \frac{3}{10} \sin t + c_1 + c_2 t + c_3 e^{-3t}, \quad t \in \mathbb{R},$$

where  $c_1, c_2, c_3 \in \mathbb{R}$  are arbitrary constants.



Discover the truth at [www.deloitte.ca/careers](http://www.deloitte.ca/careers)

**Deloitte.**

© Deloitte & Touche LLP and affiliated entities.



Click on the ad to read more

### 3 Other types of linear differential equations

**Example 3.1** 1) Find the complete solution of the differential equation

$$\frac{dx}{dt} + \left( \frac{4t^3}{1+t^4} - \frac{1}{t} \right) x = \frac{1}{t(1+t^4)}, \quad t \in \mathbb{R}_+.$$

2) Find

$$\int \frac{t}{1+t^4} dt$$

by applying the substitution  $u = t^2$ .

3) Find the complete solution of the differential equation

$$\frac{d^2x}{dt^2} + \left( \frac{4t^3}{1+t^4} - \frac{1}{t} \right) \frac{dx}{dt} = 0, \quad t \in \mathbb{R}_+.$$

**A.** Linear differential equation of first and second order of variable coefficients.

**D.** Apply the usual solution formula.

**I.** 1) From  $p(t) = \frac{4t^3}{1+t^4} - \frac{1}{t}$ ,  $t > 0$ , we get

$$P(t) = \ln(1+t^4) - \ln t,$$

hence,

$$\varphi(t) = e^{-P(t)} = \frac{t}{1+t^4}.$$

The complete solution of the homogeneous equation is

$$c \cdot \varphi(t) = c \cdot \frac{t}{1+t^4}, \quad t > 0, \quad c \in \mathbb{R}.$$

A particular solution is

$$\begin{aligned} x &= \varphi(t) \int \frac{q(t)}{\varphi(t)} dt = \frac{t}{1+t^4} \int \frac{1+t^4}{t} \cdot \frac{1}{t(1+t^4)} dt \\ &= \frac{t}{1+t^4} \int \frac{1}{t^2} dt = -\frac{1}{1+t^4}. \end{aligned}$$

The complete solution of the inhomogeneous equation is

$$x = -\frac{1}{1+t^4} + c \cdot \frac{t}{1+t^4}, \quad t > 0, \quad c \in \mathbb{R}.$$

2) **First variant.** By the substitution  $u = t^2$  we get

$$\int \frac{t}{1+t^4} dt = \frac{1}{2} \int_{u=t^2} \frac{1}{1+u^2} du = \frac{1}{2} [\text{Arctan } u]_{u=t^2} = \frac{1}{2} \text{Arctan}(t^2).$$

**Second variant.** *Decomposition.* First note that

$$\begin{aligned} 1 + t^4 &= t^4 + 2t^2 + 1 - 2t^2 = (t^2 + 1)^2 - (\sqrt{2}t)^2 \\ &= (t^2 + \sqrt{2}t + 1)(t^2 - \sqrt{2}t + 1), \end{aligned}$$

hence

$$\begin{aligned} \frac{t}{1+t^4} &= \frac{t}{(t^2 - \sqrt{2}t + 1)(t^2 + \sqrt{2}t + 1)} \\ &= \frac{1}{2\sqrt{2}} \cdot \frac{1}{t^2 - \sqrt{2}t + 1} - \frac{1}{2\sqrt{2}} \cdot \frac{1}{t^2 + \sqrt{2}t + 1} \\ &= \frac{1}{\sqrt{2}} \cdot \frac{1}{(\sqrt{2}t)^2 - 2\sqrt{2}t + 2} - \frac{1}{\sqrt{2}} \cdot \frac{1}{(\sqrt{2}t)^2 + 2\sqrt{2}t + 2} \\ &= \frac{1}{\sqrt{2}} \cdot \frac{1}{1 + (\sqrt{2}t - 1)^2} - \frac{1}{\sqrt{2}} \cdot \frac{1}{1 + (\sqrt{2}t + 1)^2}, \end{aligned}$$

and thus

$$\begin{aligned} \int \frac{t}{1+t^4} dt &= \frac{1}{\sqrt{2}} \int \frac{1}{1 + (\sqrt{2}t - 1)^2} dt - \frac{1}{\sqrt{2}} \int \frac{1}{1 + (\sqrt{2}t + 1)^2} dt \\ &= \frac{1}{2} \operatorname{Arctan}(\sqrt{2}t - 1) - \frac{1}{2} \operatorname{Arctan}(\sqrt{2}t + 1). \end{aligned}$$

It can be proved that the two solutions found by two different methods only differ by a constant.

3) If we put  $y = \frac{dx}{dt}$ , we get the equation

$$\frac{dy}{dt} + \left\{ \frac{4t^3}{1+t^4} - \frac{1}{t} \right\} y = 0, \quad t > 0.$$

This is only the homogeneous equation from (1), so the complete solution is

$$y = \frac{dx}{dt} = 2c_1 \cdot \frac{t}{1+t^4}.$$

When this equation is integrated we get by (2) that

$$\begin{aligned} x &= c_1 \{ \operatorname{Arctan}(\sqrt{2}t - 1) - \operatorname{Arctan}(\sqrt{2}t + 1) \} + c_2 \\ &= c_1 \operatorname{Arctan}(t^2) + c'_2, \quad c_1, c_2, c'_2 \in \mathbb{R}, \quad t > 0, \end{aligned}$$

which are two equivalent expressions of the complete solution of the differential equation in (3).

## 4 Mathematical models

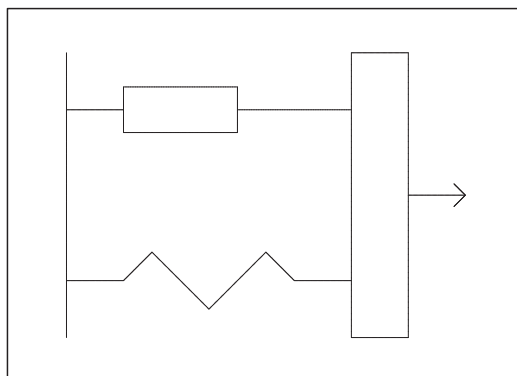

Figure 3: A mechanical system, where the mass  $m$  to the right is under influence of a force  $\mathbf{F}(t)$ , and where the mass to the left is connected with a spring (force of the spring  $k$ ) and a damper with corresponding constant  $c$ . The corresponding differential equation of the movement is

$$m \frac{d^2 x}{dt^2} + c \frac{dx}{dt} = kx = F(t).$$

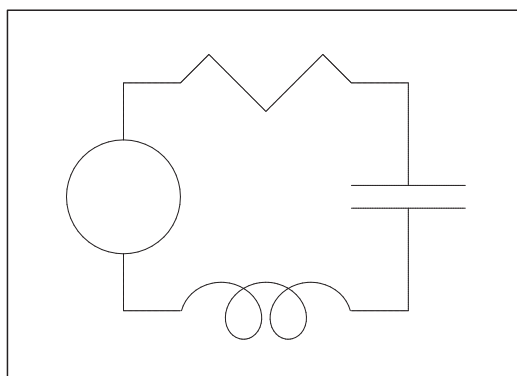

Figure 4: An electric circuit with a coil of inductance  $L$ , a resistance  $R$  and a capacitor of capacity  $C$  and a voltage generator of the voltage  $V(t)$ . The corresponding differential equation is

$$LC \frac{d^2 V_c}{dt^2} + RC \frac{dV_c}{dt} + V_c = V(t).$$

**Example 4.1** *Two physical phenomena are indicated on the figures above.*

*In the first case we consider a mass  $m$ , which moves along the  $x$ -axis. The mass is under the influence of a force of a spring  $k$ , a damper of constant  $c$  and an external force  $F(t)$ , which we here choose as  $F_0 \cos \omega t$ .*

In the second case we consider an electric circuit consisting of a coil of induction  $L$ , a resistance  $R$ , a capacitor of capacity  $C$ , and a voltage generator of voltage  $V(t)$ . We choose here  $V(t) = V_0 \sin \omega t$ .

We shall consider the following problems in the two cases. In the first case we want to find the displacement of the mass  $x(t)$  from equilibrium, and in the second case we want to find the voltage  $V_c(t)$  measured over the capacitor. These two tasks are from a mathematical point of view identical, i.e. the mathematical model is the same in the two cases. We shall not here derive how we get to this model.

1) First prove that both differential equations can be written

$$(20) \quad \frac{d^2 x}{dt^2} + 2\alpha \frac{dx}{dt} + \omega_0^2 x = f \cdot \cos \omega t, \quad t \in \mathbb{R}.$$

Here  $\alpha \geq 0$ , and we assume that  $\omega > 0$ .

2) Consider the case where the external force is 0. This corresponds to  $F_0 = V_0 = 0$ , hence

$$(21) \quad \frac{d^2 x}{dt^2} + 2\alpha \frac{dx}{dt} + \omega_0^2 x = 0, \quad t \in \mathbb{R}.$$

Find the condition for that a solution of (21) can be 0 infinitely often, and find in this case the complete solution of (21).

SIMPLY CLEVER

ŠKODA



We will turn your CV into  
an opportunity of a lifetime



Do you like cars? Would you like to be a part of a successful brand?  
We will appreciate and reward both your enthusiasm and talent.  
Send us your CV. You will be surprised where it can take you.

Send us your CV on  
[www.employerforlife.com](http://www.employerforlife.com)



Click on the ad to read more



3) Then consider (20) without a damper, corresponding to  $\alpha = 0$ . Hence

$$(22) \quad \frac{d^2x}{dt^2} + \omega_0^2 x = f \cdot \cos \omega t, \quad t \in \mathbb{R}.$$

Find for every  $\omega > 0$  the complete solution of (22).

4) For one particular value of  $\omega$  the solutions of (22) are in principle different from the solutions for all other values of  $\omega$ . Which value? How should one physically interpret the result in this case?

**A.** Models. Mathematically a linear differential equation of second order and of constant coefficients. There are given some guidelines.

**D.** Follow the guidelines.

**I.** 1) a) If we divide the equation

$$m \frac{d^2x}{dt^2} + c \frac{dx}{dt} + kx = F_0 \cos \omega t$$

by  $m > 0$ , we get

$$\frac{d^2x}{dt^2} + \frac{c}{m} \frac{dx}{dt} + \frac{k}{m} x = \frac{F_0}{m} \cos \omega t,$$

which we also write

$$\frac{d^2x}{dt^2} + 2\alpha \frac{dx}{dt} + \omega_0^2 x = f \cdot \cos \omega t$$

for

$$\alpha = \frac{c}{2m}, \quad \omega_0 = \sqrt{\frac{k}{m}} \quad \text{og} \quad f = \frac{F_0}{m}.$$

b) If we divide the equation

$$LC \frac{d^2V_c}{dt^2} + RC \frac{dV_c}{dt} + V_c = V_0 \cos \omega t$$

by  $LC > 0$  and put  $V_c$  equal to  $x$ , then

$$\frac{d^2x}{dt^2} + \frac{R}{L} \frac{dx}{dt} + \frac{1}{LC} x = \frac{V_0}{LC} \cos \omega t,$$

which is written

$$\frac{d^2x}{dt^2} + 2\alpha \frac{dx}{dt} + \omega_0^2 x = f \cdot \cos \omega t$$

for

$$\alpha = \frac{R}{2L}, \quad \omega_0 = \frac{1}{\sqrt{LC}} \quad \text{og} \quad f = \frac{V_0}{LC}.$$

2) Let

$$\frac{d^2x}{dt^2} + 2\alpha \frac{dx}{dt} + \omega_0^2 x = 0, \quad t \in \mathbb{R}, \omega_0 > 0, \quad \alpha \geq 0.$$

The characteristic polynomial

$$R^2 + 2\alpha R + \omega_0^2 = (R + \alpha)^2 + \omega_0^2 - \alpha^2$$

has the roots

$$R = \begin{cases} -\alpha \pm \sqrt{\omega_0^2 - \alpha^2}, & \text{for } \omega_0 > \alpha, \\ -\alpha \text{ (double root)}, & \text{for } \omega_0 = \alpha, \\ -\alpha \pm i\sqrt{\alpha^2 - \omega_0^2}, & \text{for } \omega_0 < \alpha. \end{cases}$$

Thus, the complete solution is

- a)  $c_1 \exp\left(\left\{-\alpha + \sqrt{\omega_0^2 - \alpha^2}\right\}t\right) + c_2 \exp\left(\left\{-\alpha - \sqrt{\omega_0^2 - \alpha^2}\right\}t\right)$ ,  
for  $\omega_0 > \alpha$ ,  
b)  $c_1 e^{-\alpha t} + c_2 t e^{-\alpha t}$ , for  $\omega_0 = \alpha$ ,  
c)  $c_1 e^{-\alpha t} \cos\left(t\sqrt{\alpha^2 - \omega_0^2}\right) + c_2 e^{-\alpha t} \sin\left(t\sqrt{\alpha^2 - \omega_0^2}\right)$ ,  
for  $\omega_0 < \alpha$ .

It follows that if  $(c_1, c_2) \neq (0, 0)$ , then the solutions are only infinitely often equal to 0 in case c). This is seen by writing the solution in c) in the following way

$$\begin{aligned} & \sqrt{c_1^2 + c_2^2} \cdot e^{-\alpha t} \left\{ \frac{c_1}{\sqrt{c_1^2 + c_2^2}} \cos\left(t\sqrt{\alpha^2 - \omega_0^2}\right) + \frac{c_2}{\sqrt{c_1^2 + c_2^2}} \sin\left(t\sqrt{\alpha^2 - \omega_0^2}\right) \right\} \\ &= \sqrt{c_1^2 + c_2^2} \cdot e^{-\alpha t} \cos\left(\sqrt{\alpha^2 - \omega_0^2}t - \varphi\right), \end{aligned}$$

where  $\varphi$  satisfies

$$\cos \varphi = \frac{c_1}{\sqrt{c_1^2 + c_2^2}}, \quad \sin \varphi = \frac{c_2}{\sqrt{c_1^2 + c_2^2}}.$$

Hence the solution takes the value 0, when

$$t_p = \frac{1}{\sqrt{\alpha^2 - \omega_0^2}} \left( \varphi + \frac{\pi}{2} + p\pi \right), \quad p \in \mathbb{Z}.$$

In the other two cases, only the zero solution is 0 infinitely often.

3) Then consider

$$\frac{d^2x}{dt^2} + \omega_0^2 x = f \cdot \cos \omega t, \quad t \in \mathbb{R}.$$

The characteristic polynomial  $R^2 + \omega_0^2$  has the roots  $\pm i\omega_0$ , hence the complete solution of the homogeneous equation is

$$c_1 \cos \omega_0 t + c_2 \sin \omega_0 t.$$

If  $\omega \neq \omega_0$ , we put  $x = c \cdot \cos \omega t$  into the left hand side of the equation. Then

$$\frac{d^2x}{dt^2} + \omega_0^2 x = c(-\omega^2 + \omega_0^2) \cos \omega t,$$

which is equal to  $f \cdot \cos \omega t$  for  $c = \frac{f}{\omega_0^2 - \omega^2}$ , and the complete solution is

$$\frac{f}{\omega_0^2 - \omega^2} \cos \omega t + c_1 \cos \omega_0 t + c_2 \sin \omega_0 t, \quad t \in \mathbb{R}, \quad c_1, c_2 \in \mathbb{R}.$$

On the other hand, if  $\omega = \omega_0$ , then put  $x = ct \sin \omega_0 t$  into the left hand side of the equation. Then by a small calculation,

$$\frac{dx}{dt} = c \cdot \sin \omega_0 t + c \omega_0 t \cos \omega_0 t,$$

$$\frac{d^2x}{dt^2} = 2\omega_0 c \cos \omega_0 t - c \omega_0^2 t \sin \omega_0 t,$$

I joined MITAS because  
I wanted **real responsibility**

The Graduate Programme  
for Engineers and Geoscientists  
[www.discovermitas.com](http://www.discovermitas.com)



**Month 16**

I was a construction  
supervisor in  
the North Sea  
advising and  
helping foremen  
solve problems

Real work  
International opportunities  
Three work placements



 **MAERSK**



hence by insertion,

$$\frac{d^2x}{dt^2} + \omega_0^2 x = 2\omega_0 c \cdot \cos \omega_0 t,$$

which is equal to  $f \cdot \cos \omega_0 t$  for  $c = \frac{f}{2\omega_0}$ . We see that in this case the complete solution is given by

$$\frac{f}{2\omega_0} t \sin \omega_0 t + c_1 \cos \omega_0 t + c_2 \sin \omega_0 t, \quad t \in \mathbb{R}, \quad c_1, c_2 \in \mathbb{R}.$$

4) The special case is of course  $\omega = \omega_0$ , where the complete solution is

$$\frac{f}{2\omega_0} t \sin \omega_0 t + c_1 \cos \omega_0 t + c_2 \sin \omega_0 t, \quad t \in \mathbb{R}, \quad c_1, c_2 \in \mathbb{R},$$

because we here get an extra factor  $t$ .

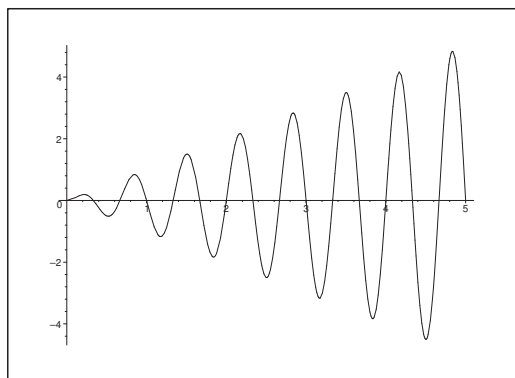

Figure 5: The graph of  $t \sin(3\pi t)$ .

We note that

$$\begin{aligned} & \lim_{\omega \rightarrow \omega_0} \frac{f}{\omega_0^2 - \omega^2} \{\cos \omega t - \cos \omega_0 t\} \\ &= \lim_{\omega \rightarrow \omega_0} \frac{-f}{\omega_0 + \omega} \cdot \frac{\cos \omega t - \cos \omega_0 t}{\omega - \omega_0} \\ &= -\frac{f}{2\omega_0} (-t \cdot \sin \omega_0 t) \\ &= \frac{ft}{2\omega_0} \cdot \sin \omega_0 t. \end{aligned}$$

This means that it is also possible to obtain the solution for  $\omega = \omega_0$  by a limit process.

The solutions of the homogeneous equation are the natural eigenfunctions of the system, so the phenomenon only means that the external force is in resonance with the eigenfunctions. We note that  $t \sin \omega_0 t$  oscillates between  $\pm t$ , so the maximum grows to infinity, when  $t$  tends to infinity.

**Example 4.2** Let us return to the electric circuit of Example 4.1. Assume that  $V(t) = V_0 \cos \omega t$ , and that we want to find the voltage  $V_c$ . It can be proved that we have for given  $V_c(t)$ ,

$$LC \frac{d^2 V_c}{dt^2} + RC \frac{dV_c}{dt} + V_c = V_0 \cos \omega t.$$

Assuming all this we consider the differential equation

$$(23) \quad \frac{d^2 x}{dt^2} + 2\alpha \frac{dx}{dt} + \omega_0^2 x = f \cdot \cos \omega t, \quad t \in \mathbb{R},$$

where all constants are positive. Let  $x_0(t)$  denote the solution which is obtained by the complex method of solution.

1) Find  $A(\omega)$ , such that  $x_0(t)$  can be written

$$x_0(t) = A(\omega) \cos(\omega t + \varphi(\omega)),$$

where the exact value of  $\varphi(\omega)$  is not required.

2) Find for every value of  $\alpha$  and  $\omega_0$ , the maximum of  $A(\omega)$ ,  $\omega > 0$ , and the value of  $\omega$ , for which we get this maximum.

**A.** Linear differential equation of second order and of constant coefficient. The complex method of solution is requested.

**D.** Put  $x = c \cdot e^{i\omega t}$ , find  $c$ , and put  $x_0(t) = \operatorname{Re} x(t)$ .

**I.** If we put  $x = c \cdot e^{i\omega t}$  into (23), we get

$$\frac{d^2 x}{dt^2} + 2\alpha \frac{dx}{dt} + \omega_0^2 x = c(-\omega^2 + 2i\alpha\omega + \omega_0^2) e^{i\omega t},$$

which is equal to  $f \omega e^{i\omega t}$  for

$$c = \frac{f \cdot \omega}{\omega_0^2 - \omega^2 + 2i\alpha\omega} = \frac{f \cdot \omega \cdot \{(\omega_0^2 - \omega^2) - 2i\alpha\omega\}}{(\omega_0^2 - \omega^2)^2 + 4\alpha^2\omega^2}.$$

Hence,

$$\begin{aligned} x_0(t) &= \operatorname{Re} \left\{ \frac{f \cdot \omega}{(\omega_0^2 - \omega^2)^2 + 4\alpha^2\omega^2} [\omega_0^2 - \omega^2 - 2i\alpha\omega] e^{i\omega t} \right\} \\ &= \frac{f \cdot \omega}{(\omega_0^2 - \omega^2)^2 + 4\alpha^2\omega^2} \{(\omega_0^2 - \omega^2) \cos \omega t + 2\alpha\omega \sin \omega t\} \\ &= \frac{f \cdot \omega}{\sqrt{(\omega_0^2 - \omega^2)^2 + 4\alpha^2\omega^2}} \left\{ \frac{\omega_0^2 - \omega^2}{\sqrt{(\omega_0^2 - \omega^2)^2 + 4\alpha^2\omega^2}} \cos \omega t \right. \\ &\quad \left. + \frac{2\alpha\omega}{\sqrt{(\omega_0^2 - \omega^2)^2 + 4\alpha^2\omega^2}} \sin \omega t \right\} \\ &= A(\omega) \cos(\omega t + \varphi), \end{aligned}$$

where

$$A(\omega) = \frac{f \cdot \omega}{\sqrt{(\omega_0^2 - \omega^2)^2 + 4\alpha^2\omega^2}}.$$

Then by a differentiation,

$$A'(\omega) = f \cdot \frac{(\omega^2 - \omega_0^2)^2 + 4\alpha^2\omega^2 - \omega\{2\omega(\omega^2 - \omega_0^2) + 4\alpha^2\omega^2\}}{\{(\omega^2 - \omega_0^2)^2 + 4\alpha^2\omega^2\}^{\frac{3}{2}}},$$

which is equal to 0 for

$$\begin{aligned} 0 &= (\omega^2 - \omega_0^2)^2 + 4\alpha^2\omega^2 - 2\omega^2(\omega^2 - \omega_0^2) - 4\alpha^2\omega^2 \\ &= -(\omega^2 - \omega_0^2)(\omega^2 + \omega_0^2), \end{aligned}$$

i.e. for  $\omega = \omega_0$ .

At the same time it is seen that  $A'(\omega) > 0$  for  $\omega \in [0, \omega_0[$ , and  $A'(\omega) < 0$  for  $\omega > \omega_0$ , so

$$A(\omega_0) = \frac{f \cdot \omega_0}{\sqrt{0^2 + 4\alpha^2\omega_0^2}} = \frac{f}{2\sqrt{\alpha}}$$

is the maximum corresponding to  $\omega = \omega_0$ .

**ie** business school

#1 EUROPEAN BUSINESS SCHOOL  
FINANCIAL TIMES  
2013

#gobeyond

**MASTER IN MANAGEMENT**

Because achieving your dreams is your greatest challenge. IE Business School's Master in Management taught in English, Spanish or bilingually, trains young high performance professionals at the beginning of their career through an innovative and stimulating program that will help them reach their full potential.

- Choose your area of specialization.
- Customize your master through the different options offered.
- Global Immersion Weeks in locations such as London, Silicon Valley or Shanghai.

*Because you change, we change with you.*

www.ie.edu/master-management | mim.admissions@ie.edu |

**Example 4.3** Let us assume the same model as in Example 4.1. Consider the differential equation

$$(24) \quad \frac{d^2x}{dt^2} + 2\alpha \frac{dx}{dt} + \omega_0^2 x = f \cdot \cos \omega t, \quad t \in \mathbb{R},$$

where the constants  $\alpha$ ,  $\omega_0$  and  $\omega$  are all positive.

Let  $x_0(t)$  denote the solution which is obtained by the complex method of solution.

1. Prove that  $x_0(t)$  can be written

$$x_0(t) = A(\omega) \cos(\omega t + \varphi(\omega)), \quad t \in \mathbb{R},$$

where

$$A(\omega) = \frac{f}{\sqrt{(\omega_0^2 - \omega^2)^2 + (2\alpha\omega)^2}}.$$

2. Prove that for every solution  $x(t)$  of (24),

$$x(t) - x_0(t) \rightarrow 0 \quad \text{for } t \rightarrow +\infty.$$

Due to the result in (2) we are mostly interested in the solution  $x_0(t)$ . For fixed  $\omega$  let  $x_0(t)$  denote an oscillation of the amplitude  $A(\omega)$ . This amplitude therefore depends of the frequency of the angle  $\omega$  on the right hand side of (24). Considered as a function in  $\omega$  we call  $A(\omega)$  the characteristics of amplitude of the differential equation (or of the corresponding physical system).

3. Find the maximum of  $A(\omega)$ ,  $\omega > 0$ , and the value of  $\omega$ , for which this maximum is attained.

(One shall be very careful here and the right time distinguish between the two cases.)

A. Linear differential operator of second order and of constant coefficients. Amplitude. There are some similarities with Example 4.2.

D. Solve the equation by the complex method. Prove that every solution of the corresponding homogeneous equation tends to 0. Find the maximum of the amplitude.

I. 1) If we put  $x = c \cdot e^{i\omega t}$  into the left hand side of the equation, we get

$$(-\omega^2 + 2i\alpha\omega + \omega_0^2) c e^{i\omega t},$$

which is equal to  $f \cdot e^{i\omega t}$  for

$$\begin{aligned} c &= \frac{f}{(\omega_0^2 - \omega^2) + 2i\alpha\omega} \\ &= \frac{f}{\sqrt{(\omega_0^2 - \omega^2)^2 + (2\alpha\omega)^2}} \cdot \frac{\omega_0^2 - \omega - 2i\alpha\omega}{\sqrt{(\omega_0^2 - \omega^2)^2 + (2\alpha\omega)^2}}. \end{aligned}$$

We note that the last factor is a complex unit vector, hence there exists a  $\varphi = \varphi(\omega)$ , such that

$$\frac{(\omega_0^2 - \omega^2) - 2i\alpha\omega}{\sqrt{(\omega_0^2 - \omega^2)^2 + (2\alpha\omega)^2}} = e^{-i\varphi}.$$

Using this  $\varphi = \varphi(\omega)$  the solution becomes

$$\begin{aligned} x_0(t) &= \operatorname{Re} \left\{ \frac{f}{\sqrt{(\omega_0^2 - \omega^2)^2 + (2\alpha\omega)^2}} \cdot e^{-i\varphi} \cdot e^{i\omega t} \right\} \\ &= \frac{f}{\sqrt{(\omega_0^2 - \omega^2)^2 + (2\alpha\omega)^2}} \cdot \cos(\omega t + \varphi) \\ &= A(\omega) \cos(\omega t + \varphi), \end{aligned}$$

where

$$A(\omega) = \frac{f}{\sqrt{(\omega_0^2 - \omega^2)^2 + (2\alpha\omega)^2}}.$$

- 2) For every solution  $x(t)$  of (24) we have that  $x(t) - x_0(t)$  is a solution of the corresponding homogeneous equation. the characteristic polynomial is

$$R^2 + 2\alpha R + \omega_0^2 = (R + \alpha)^2 + \omega_0^2 - \alpha^2.$$

Thus the roots are

$$R = \begin{cases} -\alpha \pm \sqrt{\alpha^2 - \omega_0^2}, & \text{for } \alpha > \omega_0, \\ -\alpha \quad (\text{double root}), & \text{for } \alpha = \omega_0, \\ -\alpha \pm i\sqrt{\omega_0^2 - \alpha^2}, & \text{for } \alpha < \omega_0. \end{cases}$$

Clearly,  $\operatorname{Re} R < 0$  in the latter two cases. Since  $\sqrt{\alpha^2 - \omega_0^2} < \alpha$ , this is also true in the first case, so

$$|e^{Rt}| = e^{t \operatorname{Re} R} \rightarrow 0 \quad \text{for } t \rightarrow +\infty,$$

because  $\operatorname{Re} R < 0$ , and the claim is proved.

- 3) The function  $A(\omega)$  attains its maximum, when

$$\begin{aligned} \psi(\omega) &= (\omega_0^2 - \omega^2)^2 + (2\alpha\omega)^2 \\ &= (\omega^2 - \omega_0^2)^2 + 4\alpha^2\omega^2, \quad \omega \geq 0, \end{aligned}$$

attains its minimum. We get by a differentiation,

$$\psi'(\omega) = 2(\omega^2 - \omega_0^2) \cdot 2\omega + 8\alpha^2 \cdot \omega = 4\omega \{ \omega^2 - \omega_0^2 + 2\alpha^2 \}.$$

Here, we distinguish between the two cases:

$$\text{a. } \omega_0^2 \leq 2\alpha^2, \quad \text{b. } \omega_0^2 > 2\alpha^2.$$

- a) If  $\omega_0^2 \leq 2\alpha^2$ , then  $\omega^2 - \omega_0^2 + 2\alpha^2 > 0$  for  $\omega > 0$ , hence  $\psi'(\omega) > 0$  for  $\omega > 0$ . The minimum is attained for  $\omega = 0$ , corresponding to

$$\psi(0) = \omega_0^4 \quad \text{and} \quad A(0) = \frac{f}{\sqrt{\psi(0)}} = \frac{f}{\omega_0}, \quad \omega_0^2 \leq 2\alpha^2.$$



b) If  $\omega_0^2 > 2\alpha^2$ , then  $\psi'(\omega) < 0$  for  $0 < \omega < \sqrt{\omega_0^2 - 2\alpha^2}$ , and  $\psi'(\omega) > 0$  for  $\sqrt{\omega_0^2 - 2\alpha^2} < \omega$ .  
The minimum is obtained for  $\omega = \sqrt{\omega_0^2 - 2\alpha^2}$ , corresponding to

$$\begin{aligned}\psi(\omega) &= (\omega_0 - \{\omega_0^2 - 2\alpha^2\})^2 + (2\alpha\sqrt{\omega_0^2 - 2\alpha^2})^2 \\ &= (2\alpha^2)^2 + 4\alpha^2(\omega_0^2 - 2\alpha^2) = 4\alpha^2(\omega_0^2 - \alpha^2).\end{aligned}$$

Finally, we get the maximum of  $A(\omega)$  for  $\omega = \sqrt{\omega_0^2 - 2\alpha^2}$ , and its value is

$$\begin{aligned}A\left(\sqrt{\omega_0^2 - 2\alpha^2}\right) &= \frac{f}{\sqrt{\psi\left(\sqrt{\omega_0^2 - 2\alpha^2}\right)}} \\ &= \frac{f}{2\alpha\sqrt{\omega_0^2 - \alpha^2}}, \quad \omega_0^2 > 2\alpha^2.\end{aligned}$$

**Example 4.4** A particle of mass  $m$  moves in the  $(x, y)$ -plane under the influence of the force  $\mathbf{F} = k \cdot \hat{\mathbf{v}}$ , where  $k$  is a constant, and  $\mathbf{v}$  denotes the velocity of the particle. The force  $\mathbf{F}$  is therefore always perpendicular to the velocity  $\mathbf{v}$ .

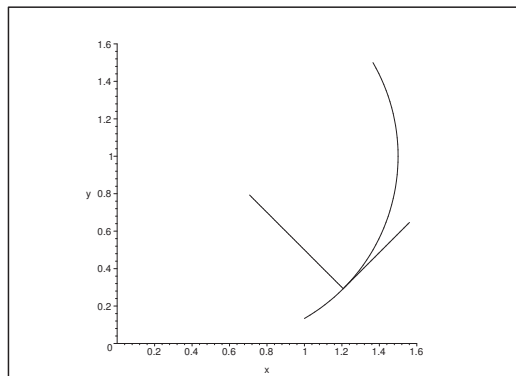

An example of such a force is given by the movement of an electron in a homogeneous magnetic field perpendicular to the  $(x, y)$ -plane. Another example is a rolling ball on a rotating foundation.

We get from Newton's second law,

$$m \frac{d\mathbf{v}}{dt} = k \hat{\mathbf{v}}.$$

If we put  $\mathbf{v}(t) = (v_x(t), v_y(t))$ , then

$$(25) \quad \begin{cases} m \frac{dv_x(t)}{dt} = -k v_y(t), \\ m \frac{dv_y(t)}{dt} = k v_x(t). \end{cases}$$

We shall here take this for granted.

1) Derive from (25) a differential equation of second order in  $v_x(t)$  and then find every possible expression of the velocity  $\mathbf{v}(t)$ .

2) Let  $x(t)$  and  $y(t)$  denote the coordinates of the particle, and assume that

$$x(0) = x_0, \quad y(0) = 0, \quad v_x(0) = 0 \quad \text{og} \quad v_y(0) = v_0,$$

where  $v_0 \neq 0$ . Then find the movement of the particle, i.e. find  $x(t)$  and  $y(t)$ . Prove in particular that the movement takes place on a circle.

- A. Derivation of a linear differential equation of second order for  $v_x$ , and the solution of this equation. Then find the movement.
- D. Differentiate the first equation of (25), and then insert into the second equation. Solve the equation.
- I. 1) We get from (25),

$$m^2 \frac{d^2 v_x(t)}{dt^2} = -km \frac{dv_y(t)}{dt} = -k^2 v_x(t),$$

hence the equation can be written

$$(26) \quad \frac{d^2 v_x}{dt^2} + \left(\frac{k}{m}\right)^2 v_x(t) = 0.$$



## STUDY AT A TOP RANKED INTERNATIONAL BUSINESS SCHOOL

Reach your full potential at the Stockholm School of Economics, in one of the most innovative cities in the world. The School is ranked by the Financial Times as the number one business school in the Nordic and Baltic countries.

Visit us at [www.hhs.se](http://www.hhs.se)







This is a linear and homogeneous differential equation of second order and of constant coefficients. The characteristic polynomial

$$R^2 + \left(\frac{k}{m}\right)^2$$

has the roots  $\pm i \frac{k}{m}$ , hence the complete solution of (26) is given by

$$v_x(t) = c_1 \cos\left(\frac{k}{m}t\right) + c_2 \sin\left(\frac{k}{m}t\right) = A \cos\left(\frac{k}{m}t + \varphi\right).$$

From this expression and the first equation of (25) we then get

$$v_y(t) = -\frac{m}{k} \frac{dv_x(t)}{dt} = A \sin\left(\frac{k}{m}t + \varphi\right).$$

Therefore, the possible solutions are given by

$$(v_x(t), v_y(t)) = A \left( \cos\left(\frac{k}{m}t + \varphi\right), \sin\left(\frac{k}{m}t + \varphi\right) \right).$$

2) Now, let  $\frac{dx}{dt} = v_x(t)$  and  $\frac{dy}{dt} = v_y(t)$  with the initial conditions

$$x(0) = x_0, \quad y(0) = 0, \quad v_x(0) = 0, \quad v_y(0) = v_0 \neq 0.$$

Then we conclude from (1) that

$$(v_x(t), v_y(t)) = A \left( \cos\left(\frac{k}{m}t + \varphi\right), \sin\left(\frac{k}{m}t + \varphi\right) \right).$$

If we put  $t = 0$ , we get

$$(v_x(0), v_y(0)) = (0, v_0) = A (\cos \varphi, \sin \varphi),$$

thus  $A = v_0$  and  $\varphi = \frac{\pi}{2}$ . Then

$$\begin{cases} \frac{dx}{dt} = v_x(t) = v_0 \cos\left(\frac{k}{m}t + \frac{\pi}{2}\right) = -v_0 \sin\left(\frac{k}{m}t\right), \\ \frac{dy}{dt} = v_y(t) = v_0 \sin\left(\frac{k}{m}t + \frac{\pi}{2}\right) = v_0 \cos\left(\frac{k}{m}t\right). \end{cases}$$

By an integration,

$$\begin{cases} x(t) = v_0 \cdot \frac{m}{k} \cos\left(\frac{k}{m}t\right) + c_1, \\ y(t) = v_0 \cdot \frac{m}{k} \sin\left(\frac{k}{m}t\right) + c_2, \end{cases}$$

hence

$$c_1 = x(0) - v_0 \cdot \frac{m}{k} = x_0 - \frac{v_0 m}{k}, \quad c_2 = y(0) - 0 = y_0.$$

The solution is

$$\begin{aligned} (x(t), y(t)) &= (c_1, c_2) + \frac{v_0 m}{k} \left( \cos\left(\frac{k}{m} t\right), \sin\left(\frac{k}{m} t\right) \right) \\ &= \left(x_0 - \frac{v_0 m}{k}, y_0\right) + \frac{v_0 m}{k} \left( \cos\left(\frac{k}{m} t\right), \sin\left(\frac{k}{m} t\right) \right), \\ &\text{for } t \in \mathbb{R}, \end{aligned}$$

which describes a circular movement with

centre:  $\left(x_0 - \frac{v_0 m}{k}, y_0\right)$  and radius:  $\left|\frac{v_0 m}{k}\right|$ .

**Example 4.5** On the figure is shown a setting up, where a horizontal disc is turned with a constant velocity of the angle  $\Omega$ . the mass  $m$  moves frictionless in a pipe which is fixed on the disc, and  $k$  is the resistance of the spring. Let  $x(t)$  denote the oscillation of the mass from equilibrium. The constants  $k$  and  $m$  are in the following kept fixed, and the movement of the mass then only depends on the velocity of the angle  $\Omega$ . It can be proved that we as a mathematical model can use the differential equation

$$(27) \quad \frac{d^2 x}{dt^2} + \left(\frac{k}{m} - \Omega^2\right) x = 0, \quad t \geq 0.$$

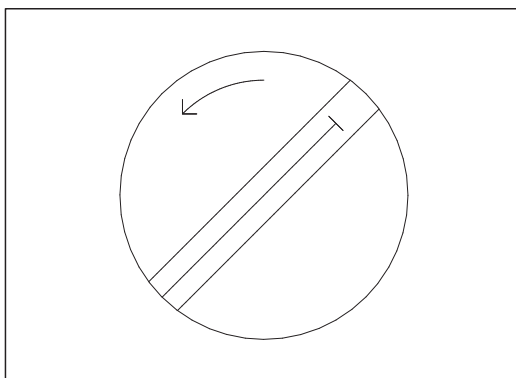

Figure 6: A disc rotating with the velocity of the angle  $\Omega$  with a particle  $m$  fixed to a spring  $k$  in a pipe which is fixed on the disc.

- 1) Find the values of  $\Omega \in [0, +\infty[$ , for which the mass oscillates harmonically (i.e. like either a cosine or a sinus).
- 2) If the mass does not oscillate harmonically, then describe its movement. The model (27) only gives a few possibilities, which should be indicated.
- 3) Find  $\Omega$ , such that (27) has a solution  $x(t)$  satisfying

$$x(t) \rightarrow 0 \text{ for } t \rightarrow +\infty, \quad x(0) = 1, \quad x'(0) = -\sqrt{\frac{k}{m}}.$$

A. A mathematical model, which eventually is reduced to a linear and homogeneous differential equation of second order and of constant coefficients.

D. Analyze the characteristic polynomial. Solve the equation.

I. 1) The characteristic polynomial

$$R^2 + \left(\frac{k}{m} - \Omega^2\right)$$

has the roots

$$R = \begin{cases} \pm\sqrt{\Omega^2 - \frac{k}{m}}, & \text{for } \Omega > \sqrt{\frac{k}{m}}, \\ 0 \text{ (double root)}, & \text{for } \Omega = \sqrt{\frac{k}{m}}, \\ \pm i\sqrt{\frac{k}{m} - \Omega^2}, & \text{for } 0 \leq \Omega < \sqrt{\frac{k}{m}}. \end{cases}$$

Only pure imaginary roots can give harmonic solutions, so we conclude that the mass oscillates harmonically, if and only if  $\Omega \in \left[0, \sqrt{\frac{k}{m}}\right]$ .

2) If  $\Omega = \sqrt{\frac{k}{m}}$ , then the solutions are

$$x = c_1 + c_2 t, \quad t \in \mathbb{R}, \quad c_1, c_2 \in \mathbb{R},$$

so either the particle is lying permanently in the position  $x = c_1$  (when  $c_2 = 0$ ), or it tends to  $\pm\infty$  (depending on the sign of  $c_2$ ) for  $t$  tending to infinity.

If  $\Omega > \sqrt{\frac{k}{m}}$ , then the solutions are

$$x = c_1 \exp\left(\sqrt{\Omega^2 - \frac{k}{m}} t\right) + c_2 \exp\left(-\sqrt{\Omega^2 - \frac{k}{m}} t\right).$$

If  $c_1 = 0$ , the movement of the particle is damped, i.e. it tends to the position of rest  $x = 0$  for  $t \rightarrow +\infty$ .

If  $c_1 \neq 0$ , then  $|x(t)|$  tends exponentially towards  $+\infty$ .

In practice, none of the unbounded solutions can be realized, because the spring will be torn into pieces for large  $t > 0$ .

3) If  $x(t) \rightarrow 0$  for  $t \rightarrow +\infty$ , then we must according to (2) either have the zero solution (which is not possible, because  $x(0) = 1$ ), or

$$x = c \cdot \exp\left(-\sqrt{\Omega^2 - \frac{k}{m}} t\right), \quad \Omega > \sqrt{\frac{k}{m}}.$$

Then

$$\frac{dx}{dt} = -c\sqrt{\Omega^2 - \frac{k}{m}} \cdot \exp\left(-\sqrt{\Omega^2 - \frac{k}{m}} t\right) = -\sqrt{\Omega^2 - \frac{k}{m}} \cdot x(t).$$

From  $x(0) = 1$  we get that  $c = 1$ . Furthermore, since  $x'(0) = -\sqrt{\frac{k}{m}}$ ,

$$-\sqrt{\Omega^2 - \frac{k}{m}} = -\sqrt{\frac{k}{m}}, \quad \text{dvs.} \quad \Omega^2 = \frac{2k}{m}.$$

From  $\Omega > 0$  we get

$$\Omega = \sqrt{\frac{2k}{m}} \quad \left( > \sqrt{\frac{k}{m}} \right).$$

Since  $\Omega^2 - \frac{k}{m} = \frac{k}{m}$ , the wanted solution is

$$x = \exp\left(-\frac{k}{m} t\right), \quad t \in \mathbb{R},$$

which clearly satisfies the given conditions.



**#1**  
in eco-friendly  
attitude

**STUDY AT  
LINKÖPING UNIVERSITY, SWEDEN**  
RANKED AMONG TOP 50 UNIVERSITIES UNDER 50

Interested in Strategy and Management in International Organisations? Kick-start your career with a master's degree from Linköping University, Sweden.

→ **Click here!**

 **Linköping University**



**Example 4.6** Consider a shaft, which is supported in its two end points. These are described on the oriented shaft by  $x = 0$  and  $x = \ell$ , where  $\ell$  denotes the length of the shaft. When the shaft rotates, it can under certain conditions rotate in a bent form.

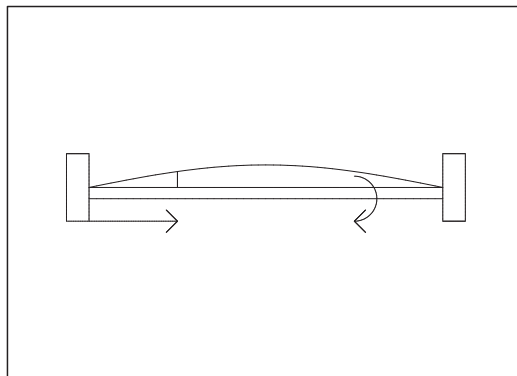

Figure 7: Sketch of a rotating shaft with the bending  $u(x)$ .

the differential equation for the bending  $u$  of a rotating shaft is

$$(28) \quad (EI) \frac{d^4 u}{dx^4} - \left( \frac{p\omega^2}{g} \right) u = 0,$$

where  $p$  indicates the weight per length, and  $\omega$  the constant velocity of the angle, and  $g$  the gravity, and  $E$  the module of elasticity of the shaft, and finally,  $I$  a cross section constant. The differential equation only gives a good description for a small bending.

1. Find the complete solution of (28).

That the shaft can rotate in a bent form can be proved to be equivalent to that (28) has a solution which is not the zero solution, where

$$u(0) = u''(0) = u(\ell) = u''(\ell) = 0.$$

We call the values of  $\omega$ , for which this phenomenon occur for the critical velocities of the angle.

In the rest of this example we shall find these velocities of the angle. Therefore, consider a solution  $u(x)$  of (28).

2. Prove that the conditions  $u(0) = u''(0)$  are satisfied, if and only if  $u(x)$  can be written

$$u(x) = d_1 \sin(kx) + d_2 \sin(kx),$$

for some constants  $d_1$  and  $d_2$ , where  $k$  is referring back to (28).

3. Then prove that if  $u(\ell) = u''(\ell) = 0$ , then  $d_1 = 0$ , and then find the critical velocities of the angle.

**A.** Linear homogeneous differential equation of fourth order and of constant coefficients.

**D.** Find the complete solution. Insert the boundary conditions.

I. 1) The characteristic polynomial

$$EI \cdot R^4 - \frac{p\omega^2}{g} = EI \left( R^4 - \frac{p\omega^2}{gEI} \right) = EI \left( R^2 - \sqrt{\frac{p\omega^2}{gEI}} \right) \left( R^2 + \sqrt{\frac{p\omega^2}{gEI}} \right)$$

has the roots

$$R = \pm \sqrt[4]{\frac{p\omega^2}{gEI}}, \quad R = \pm i \sqrt[4]{\frac{p\omega^2}{gEI}}.$$

If we put

$$k = k(\omega) = \sqrt[4]{\frac{p\omega^2}{gEI}},$$

then the complete solution becomes

$$u(x) = c_1 \cosh(kx) + c_2 \sinh(kx) + c_3 \cos(kx) + c_4 \sin(kx), \\ t \in \mathbb{R}, \quad c_1, \dots, c_4 \in \mathbb{R}.$$

2) Let

$$u(x) = c_1 \cosh(kx) + c_2 \sinh(kx) + c_3 \cos(kx) + c_4 \sin(kx).$$

Then

$$u''(x) = c_1 k^2 \cosh(kx) + c_2 k^2 \sinh(kx) - c_3 k^2 \cos(kx) - c_4 k^2 \sin(kx).$$

From  $u(0) = u''(0) = 0$  we get

$$c_1 + c_3 = 0 \quad \text{and} \quad k^2(c_1 - c_3) = 0,$$

so  $c_1 = c_3 = 0$ , and thus

$$u(x) = c_2 \sinh(kx) + c_4 \sin(kx), \quad k = k(\omega) = \sqrt[4]{\frac{p\omega^2}{gEI}}.$$

3) Furthermore, if  $u(\ell) = u''(\ell) = 0$ , then we get for the solution  $u$  from (2) that

$$u(\ell) = 0 = c_2 \sinh(k\ell) + c_4 \sin(k\ell), \\ u''(\ell) = 0 = c_2 k^2 \sinh(k\ell) - c_4 k^2 \sin(k\ell),$$

so it follows immediately that

$$c_2 \sinh(k\ell) = 0 \quad \text{and} \quad c_4 \sin(k\ell) = 0.$$

Now,  $k\ell > 0$ , so  $\sinh(k\ell) > 0$ , and it follows that  $c_2 = 0$ .

It only remains the term

$$u(x) = c_4 \sin(kx), \quad k = \sqrt[4]{\frac{p\omega^2}{gEI}},$$



where the condition is

$$0 < kl = \sqrt[4]{\frac{p\omega^2}{gEI}} \cdot \ell = n\pi, \quad n \in \mathbb{N}.$$

The task is to find all possible  $\omega$  for which this holds. Since

$$\sqrt{\omega} = \sqrt[4]{\frac{gEI}{p}} \cdot \frac{n\pi}{\ell}, \quad n \in \mathbb{N},$$

we finally get

$$\omega = \sqrt{\frac{gEI}{p}} \cdot \frac{\pi^2}{\ell^2} \cdot n^2, \quad n \in \mathbb{N}.$$

**Example 4.7** A cable, which is fastened in two points, is hanging under the influence of its own weight. Place a usual  $(x, y)$ -coordinate system such that the origo lies at the lowest point of the cable and such that the  $x$ -axis has the same direction as the tangent at this point. By a consideration of the equilibrium it can be proved that the cable describes a curve  $y = \varphi(x)$ , which satisfies the differential equation

$$(29) \quad \frac{d^2y}{dx^2} = \frac{W}{K} \sqrt{1 + \left(\frac{dy}{dx}\right)^2},$$

where  $W$  and  $K$  are positive constants.

- 1) Find the complete solution of (29) by first finding  $\frac{dy}{dx}$ .
- 2) Then find  $y = \varphi(x)$ .

(The result gives the reasons for why the graph of this function is often called the chain curve.)

**A.** A non-linear differential equation of second order, which can be reduced to a system of two differential equations of first order

**D.** Put  $u = \frac{dy}{dx}$ , and then separate the variables. Exploit that the minimum lies at  $(0, 0)$ .

**I.** 1) If we put  $u = \frac{dy}{dx}$ , then (29) becomes

$$\frac{du}{dx} = \frac{W}{K} \sqrt{1 + u^2}, \quad u = \frac{dy}{dx}.$$

The first equation is solved by separating the variables:

$$\frac{W}{K} x + c_1 = \int \frac{1}{\sqrt{1 + u^2}} du = \operatorname{Arsinh} u,$$

hence

$$u = \frac{dy}{dx} = \sinh \left( \frac{W}{K} x + c_1 \right).$$

Then by a simple integration,

$$y = \frac{K}{W} \cosh\left(\frac{W}{K}x + c_1\right) + c_2.$$

2) If  $x = 0$ , then  $\varphi(0) = 0$  and  $\varphi'(0) = 0$ , so

$$\varphi(0) = \frac{K}{W} \cosh(c_1) + c_2 = 0, \quad \varphi'(0) = \sinh(c_1) = 0.$$

From the latter equation we get  $c_1 = 0$ , which by insertion into the former one gives

$$c_2 = -\frac{K}{W} \cosh 0 = -\frac{K}{W}.$$

Thus the solution is

$$y = \varphi(x) = \frac{K}{W} \left\{ \cosh\left(\frac{W}{K}x\right) - 1 \right\}.$$

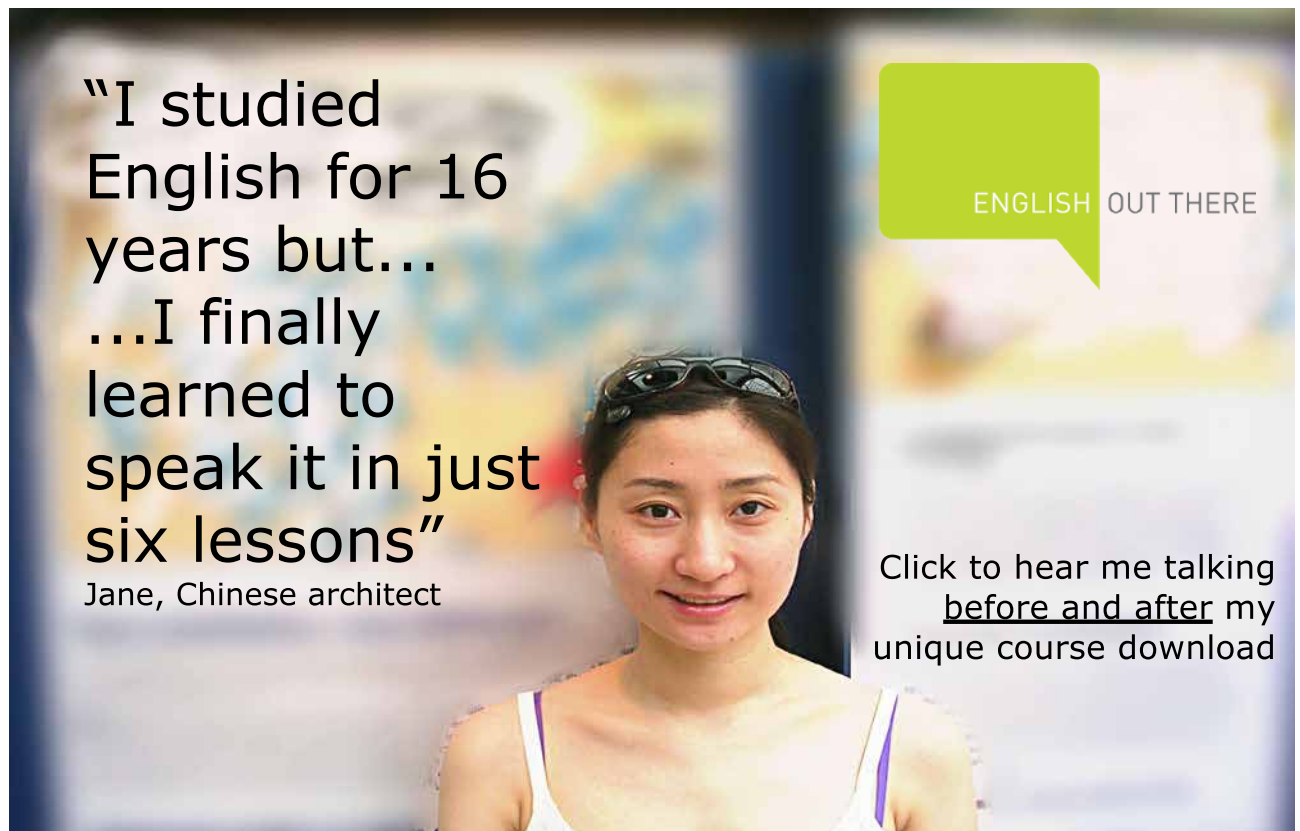

“I studied English for 16 years but...  
...I finally learned to speak it in just six lessons”  
Jane, Chinese architect

ENGLISH OUT THERE

Click to hear me talking before and after my unique course download



**Example 4.8** Consider a beam of length  $\ell$ , which is clamped at its left end point, while it in its right end point is under the influence of a pressure  $P$ . Let  $u(x)$  denote the bending of the beam (cf. the figure).

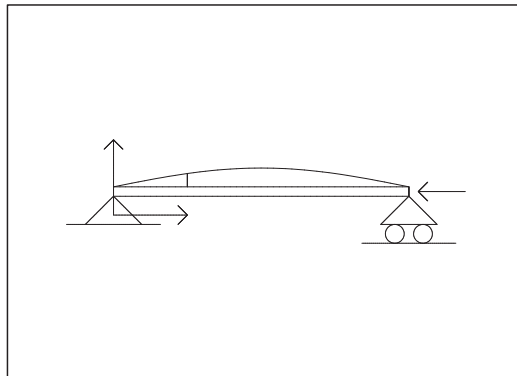

Figure 8: A clamped beam under influence of a pressure  $P$  from the right.

It turns up that the beam is only bending due to the force  $P$  in some special situations. We shall discuss this by using the mathematical model of the differential equation

$$(30) \quad \frac{d^4 u}{dx^4} + P \frac{d^2 u}{dx^2} = 0, \quad 0 \leq x \leq \ell, \quad P > 0,$$

where for every bending  $u(x)$ ,

$$(31) \quad u(0) = 0, \quad u''(0) = 0, \quad u(\ell) = 0, \quad u''(\ell) = 0.$$

We shall take all this for granted in the following.

- 1) First find the complete solution of (30).
- 2) Then find all solutions of (30), for which the conditions in (31) are also fulfilled.
- 3) Find those values of  $P$ , for which the beam is bending, i.e. where  $u(x)$  is not identically zero, and find the corresponding bending  $u(x)$ .

**A.** Linear homogeneous differential equation of fourth order and of constant coefficients. There are given some guidelines.

**D.** Follow the guidelines (the characteristic polynomial etc.).

**I.** 1) The characteristic polynomial

$$R^4 + PR^2 = R^2(R^2 + P), \quad P > 0,$$

has the roots

$$R = 0 \quad (\text{double root}) \quad \text{and} \quad R = \pm i\sqrt{P},$$

so the complete solution of (30) is

$$u(x) = c_1 + c_2 x + c_3 \cos(\sqrt{P}x) + c_4 \sin(\sqrt{P}x), \quad x \in [0, \ell],$$

where  $c_1, \dots, c_4 \in \mathbb{R}$  are arbitrary constants.

2) If

$$u(x) = c_1 + c_2x + c_3 \cos(\sqrt{P}x) + c_4 \sin(\sqrt{P}x),$$

then

$$\frac{d^2u}{dx^2} = -c_3P \cos(\sqrt{P}x) - c_4P \sin(\sqrt{P}x).$$

Then by insertion into (31),

$$u(0) = 0 = c_1 + c_3, \quad u''(0) = 0 = -c_3P,$$

thus  $c_3 = c_1 = 0$ , and it only remains

$$u = c_2x + c_4 \sin(\sqrt{P}x), \quad \frac{d^2u}{dx^2} = -c_4P \sin(\sqrt{P}x).$$

If  $u(\ell) = u''(\ell) = 0$ , we clearly get  $c_2\ell = 0$ , i.e.  $c_2 = 0$ , so the possible solutions are

$$u = c \cdot \sin(\sqrt{P}x),$$

where

$$u''(\ell) = 0 = -cP \sin(\sqrt{P}\ell).$$

Since  $c \neq 0$  for a bending, we must have  $\sin(\sqrt{P} \cdot \ell) = 0$ . This condition means that

$$\sqrt{P} \cdot \ell = n\pi, \quad \text{i.e. } P = \left(\frac{n\pi}{\ell}\right)^2, \quad n \in \mathbb{N}.$$

3) According to (2) the solution is only different from the zero function, if

$$P_n = \frac{\pi^2}{\ell^2} \cdot n^2, \quad n \in \mathbb{N}.$$

In this case,

$$u(x) = c \cdot \sin(\sqrt{P_n}x) = c \cdot \left(\frac{\pi}{\ell} \cdot nx\right), \quad x \in [0, \ell],$$

where  $c \in \mathbb{R}$  and  $n \in \mathbb{N}$ .

Note in particular that the arbitrary constant  $c \in \mathbb{R}$  *cannot* be fixed by the given conditions.

**Example 4.9** Consider a beam of length  $\ell$ , which is clamped at its left end point, while it at its right end point is under the influence of a pressure  $P$ . Let  $u(x)$  denote the bending of the beam, cf. the figure. Unlike Example 4.8 we here assume that the bending has a horizontal tangent at the left end point.

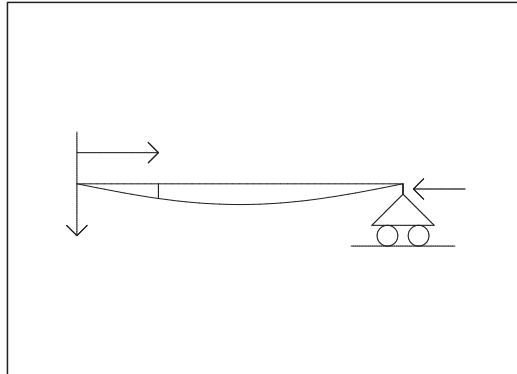

Figure 9: A clamped beam experiencing a pressure from the right.

We use as a mathematical model the differential equation

$$(32) \quad \frac{d^4 u}{dx^4} + P \frac{d^2 u}{dx^2} = 0, \quad 0 \leq x \leq \ell, \quad P > 0,$$

where for every bending  $u(x)$ ,

$$(33) \quad u(0) = 0, \quad u'(0) = 0, \quad u(\ell) = 0, \quad u''(\ell) = 0.$$

We shall take the above for granted in the following.

- 1) Find the complete solution of (32).
- 2) A real bending of the beam corresponds to a non-zero solution  $u(x)$  of (32), for which the conditions (33) are fulfilled. Prove that this only is possible, if

$$\tan(\sqrt{P} \ell) = \sqrt{P} \ell.$$

- 3) Find every possible bending of the beam.

**A.** Same differential equation as in Example 4.8, i.e. a linear homogeneous differential equation of fourth order and of constant coefficients. Only the boundary conditions have changed. There are given some guidelines.

**D.** Follow the guidelines.

**I.** 1) This is the same question as (1) in Example 4.8.

The characteristic polynomial

$$R^4 + PR^2 = R^2(R^2 + P)$$

has the roots

$$R = 0 \quad (\text{double root}) \quad \text{and} \quad R = \pm i\sqrt{P}.$$

Therefore, the complete solution is

$$x = c_1 + c_2 t + c_3 \cos(\sqrt{P} x) + c_4 \sin(\sqrt{P} x), \quad x \in [0, \ell],$$

where  $c_1, \dots, c_4 \in \mathbb{R}$  are arbitrary constants.

2) Let

$$u = c_1 + c_2 x + c_3 \cos(\sqrt{P} x) + c_4 \sin(\sqrt{P} x).$$

Then

$$\frac{du}{dx} = c_2 + c_4 \sqrt{P} \cos(\sqrt{P} x) - c_3 \sqrt{P} \sin(\sqrt{P} x),$$

$$\frac{u^2 u}{dx^2} = -c_3 P \cos(\sqrt{P} x) - c_4 P \sin(\sqrt{P} x).$$

Excellent Economics and Business programmes at:



**university of  
 groningen**



**“The perfect start  
 of a successful,  
 international career.”**

**CLICK HERE**  
 to discover why both socially  
 and academically the University  
 of Groningen is one of the best  
 places for a student to be

[www.rug.nl/feb/education](http://www.rug.nl/feb/education)



It follows from (33) that

$$\begin{cases} u(0) = 0 = c_1 + c_3, \\ u'(0) = 0 = c_2 + c_4\sqrt{P}, \\ u(\ell) = 0 = c_1 + c_2\ell + c_3 \cos(\sqrt{P}\ell) + c_4 \sin(\sqrt{P}\ell), \\ u''(\ell) = 0 = -P \{c_3 \cos(\sqrt{P}\ell) + c_4 \sin(\sqrt{P}\ell)\}, \end{cases}$$

from which immediately follows that  $c_1 + c_2\ell = c_1 + c_3 = 0$  and

$$c_3 \cos(\sqrt{P}\ell) + c_4 \sin(\sqrt{P}\ell) = 0.$$

Hence

$$\tan(\sqrt{P}\ell) = -\frac{c_3}{c_4},$$

and since  $c_4 = -\frac{c_2}{\sqrt{P}}$  and  $c_3 = c_2\ell$ , we get by insertion,

$$\tan(\sqrt{P}\ell) = -\frac{c_2\ell}{-\frac{c_2}{\sqrt{P}}} = \sqrt{P}\ell. \quad \text{Q.E.D.}$$

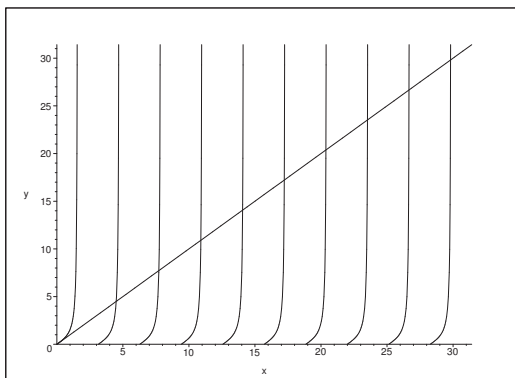

Figure 10: The intersection points  $x = \sqrt{P}\ell$  of the curves  $x$  and  $\tan x$ .

3) If we use  $c = c_2$  as our parameter, it follows from (2) that

$$c_1 = -c_3 = -c \cdot \ell, \quad c_2 = c, \quad c_3 = c \cdot \ell, \quad c_4 = -c,$$

and the solutions are

$$u(x) = c \left\{ \ell \cdot \cos(\sqrt{P}x) - \sin(\sqrt{P}x) - (\ell - x) \right\},$$

where  $\sqrt{P} \cdot \ell$  satisfies the equation

$$\tan(\sqrt{P}\ell) = \sqrt{P}\ell.$$

We note that  $c \in \mathbb{R}$  can be chosen arbitrarily, so the solution is not uniquely determined by these conditions.

**Example 4.10** Consider a disc, which rotates with a constant velocity of the the angle  $\Omega$ . An elastic rod is fastened in one of its end points to the periphery of the disc, while there in the other end point is a particle of mass 1. We shall furthermore assume that the length of the rod is 1. We denote by  $x(\ell)$  the deviation of the rod from the diameter of the disc (cf. the figure).

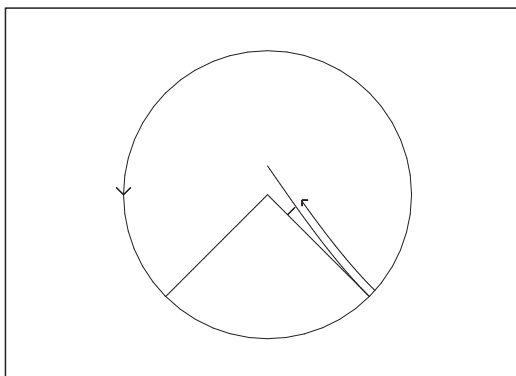

Figure 11: Rotating disc with an elastic rod fastened to its periphery.

The radius of the disc is  $r$ . When the disc rotates, the rod will (only) bend for some values of  $\Omega$ .

For simplicity we shall only consider that situation, where the bending  $x(\ell)$  fulfils  $x(1) = 0.1$ . As a mathematical model we shall use the differential equation

$$(34) \quad \frac{d^3x}{d\ell^3} + \Omega^2 (r - 1) \frac{dx}{d\ell} = \Omega^2 \cdot 0, 1, \quad 0 \leq \ell \leq 1,$$

and for a bending where  $x(1) = 0.1$  we shall also require that

$$(35) \quad x(0) = 0, \quad x'(0) = 0, \quad x''(1) = 0, \quad x(1) = 0, 1.$$

- 1) Find the complete solution of the differential equation (34) in each of the cases  $r < 1$ ,  $r = 1$  and  $r > 1$ .
- 2) Let us consider the case  $r < 1$ . First find the complete solution of (34) by means of the hyperbolic functions. Then prove that (34) has a solution which satisfies the conditions (35), only if the velocity of the angle  $\Omega$  satisfies

$$\tanh(\Omega\sqrt{1-r}) = r \Omega \sqrt{1-r}.$$

**A.** I found this example in some book on Calculus, and I must say for one that I feel quite uneasy with the physical model. In the original example the condition of the bending was  $x(1) = 1$ , which means that the rod is always perpendicular of the diameter! When I pointed this out to the authors, the condition was changed to  $x(1) = 0.1$ . This is still wrong, because we must assume that the bending is perpendicular to the diameter, and the most natural thing would be to place the coordinate system along the diameter. This violates the geometry of the problem! In fact, draw the cord between the particle and the point of the rod on the periphery. Then this cord is clearly shorter than the length 1 of the rod, and on the other hand it is also the hypotenuse of a rectangular triangle, in which one of the shorter sides (given by the projection of the particle onto the diameter) is 1. This is not possible in Euclidean geometry.



Finally, we must consider the possibility of the coordinate axis to follow the elastic rod. But then the condition  $x(1) = 0.1$  on the particle implies that it must move on a line parallel with the diameter in the distance of 0.1, so there must be a groove here. I can find nothing of the kind in the example, so this is an unhappy example of a mathematical model where the requirement of being solvable forces the authors to even violate the Euclidean geometry.

Let us forget the physical model, which apparently cannot be repaired in a reasonable way, and instead turn to the mathematical task which still has a well-defined meaning, and which can be solved. We have a linear inhomogeneous differential equation of third order and of constant coefficients.

**D.** Find the roots of the characteristic polynomial in the three cases  $r < 1$ ,  $r = 1$  and  $r > 1$ . Guess a solution.

**I.** 1) The characteristic polynomial is

$$R^3 + \Omega^2 \cdot (r - 1) R = R \{R^2 + \Omega^2 \cdot (r - 1)\}.$$

a) If  $0 < r < 1$ , then the roots are

$$R = 0 \quad \text{and} \quad R = \pm \Omega \sqrt{1 - r},$$

and the complete solution of the homogeneous equation is

$$x(\ell) = c_1 + c_2 \cosh(\Omega \sqrt{1 - r} \ell) + c_3 \sinh(\Omega \sqrt{1 - r} \ell), \quad \ell \in [0, 1],$$

where  $c_1, c_2, c_3 \in \mathbb{R}$  are arbitrary constants.

We immediately guess the particular solution  $x = \frac{\ell}{10(1 - r)}$ , so the complete solution is

$$x(\ell) = \frac{\ell}{10(1 - r)} + c_1 + c_2 \cosh(\Omega \sqrt{1 - r} \ell) + c_3 \sinh(\Omega \sqrt{1 - r} \ell).$$

b) If  $r = 1$ , then  $R = 0$  is a treble root, so the homogeneous equation has the complete solution

$$c_1 + c_2 \ell + c_3 \ell^2, \quad \ell \in [0, 1], \quad c_1, c_2, c_3 \in \mathbb{R}.$$

We guess the particular solution  $x = c \cdot \ell^3$ . Then it follows from (34) that  $6c = -0,1 \cdot \Omega^2$ , i.e.  $c = -\frac{1}{60} \Omega^2$ , and the complete solution is

$$x(\ell) = -\frac{1}{60} \Omega \ell^3 + c_1 + c_2 \ell + c_3 \ell^2, \quad \ell \in [0, 1], \quad c_1, c_2, c_3 \in \mathbb{R}.$$

c) If  $r > 1$ , then the roots are

$$R = 0 \quad R = \pm i \Omega \sqrt{r - 1},$$

and a particular solution is  $x = -\frac{\ell}{10(r - 1)}$ . Thus the complete solution is

$$x(\ell) = -\frac{\ell}{10(r - 1)} + c_1 + c_2 \cos(\Omega \sqrt{r - 1} \ell) + c_3 \sin(\Omega \sqrt{r - 1} \ell),$$

where  $\ell \in [0, 1]$ , and where  $c_1, c_2, c_3 \in \mathbb{R}$  are arbitrary constants.

2) Let  $r < 1$ . According to (1a) above, the complete solution of (34) is

$$x(\ell) = \frac{\ell}{10(1-r)} + c_1 + c_2 \cosh(\Omega \sqrt{1-r} \ell) + c_3 \sinh(\Omega \sqrt{1-r} \ell).$$

Hence

$$x'(\ell) = \frac{1}{10(1-r)} + c_3 \Omega \sqrt{1-r} \cosh(\Omega \sqrt{1-r} \ell) + c_2 \Omega \sqrt{1-r} \sinh(\Omega \sqrt{1-r} \ell),$$

$$x''(\ell) = c_2 \Omega^2 (1-r) \cosh(\Omega \sqrt{1-r} \ell) + c_3 \Omega^2 (1-r) \sinh(\Omega \sqrt{1-r} \ell).$$

We get from the boundary conditions (35) that

$$\begin{cases} x(0) &= 0 = c_1 + c_2, \\ x'(0) &= 0 = \frac{1}{10(1-r)} + c_3 \Omega \sqrt{1-r}, \\ x''(1) &= 0 = \Omega^2 (1-r) \{c_2 \cosh(\Omega \sqrt{1-r}) + c_3 \sinh(\Omega \sqrt{1-r})\}, \\ x(1) &= \frac{1}{10} = \frac{1}{10(1-r)} + c_1 + c_2 \cosh(\Omega \sqrt{1-r}) + c_3 \sinh(\Omega \sqrt{1-r}). \end{cases}$$



In the past four years we have drilled

# 89,000 km

That's more than **twice** around the world.

**Who are we?**  
We are the world's largest oilfield services company<sup>1</sup>. Working globally—often in remote and challenging locations—we invent, design, engineer, and apply technology to help our customers find and produce oil and gas safely.

**Who are we looking for?**  
Every year, we need thousands of graduates to begin dynamic careers in the following domains:

- Engineering, Research and Operations
- Geoscience and Petrotechnical
- Commercial and Business

**What will you be?**

[careers.slb.com](http://careers.slb.com)

**Schlumberger**

<sup>1</sup>Based on Fortune 500 ranking 2011. Copyright © 2015 Schlumberger. All rights reserved.

Then from the third equation,

$$\tanh(\Omega\sqrt{1-r}) = -\frac{c_2}{c_3}.$$

We conclude from the third and the fourth equation that

$$c_1 = \frac{1}{10} \left( 1 - \frac{1}{1-r} \right) = -\frac{1}{10} \cdot \frac{r}{1-r},$$

so

$$c_2 = \frac{1}{10} \cdot \frac{r}{1-r}$$

by the first equation.

Finally, it follows from the second equation that

$$c_3 = -\frac{1}{10} \cdot \frac{1}{\Omega(1-r)\sqrt{1-r}}.$$

Then by insertion,

$$\tanh(\Omega\sqrt{1-r}) = -\frac{c_1}{c_3} = -\frac{\frac{1}{10}}{\frac{1}{10}} \cdot \frac{r}{1-r} (-\Omega(1-r)\sqrt{1-r}) = r\Omega\sqrt{1-r}$$

as required.

**Example 4.11** We have for a pipe formed chemical reactor the differential equation

$$\frac{d^2c}{dx^2} - \frac{dc}{dx} - \frac{3}{4}c = -7\exp\left(-\frac{1}{4}x\right) - 6\exp\left(-\frac{1}{2}x\right),$$

where  $c$  denotes the concentration of some unspecified matter, and where  $x$  is a coordinate.

- 1) Find the complete solution.
- 2) Find the particular solution  $c(x)$ , for which

$$c(0) = 2 \quad \text{and} \quad \frac{dc}{dx}(0) = 6.$$

**A.** Linear inhomogeneous differential equation of second order and of constant coefficients.

**D.** Find the roots of the characteristic polynomial; then guess a particular solution.

**I.** 1) The characteristic polynomial

$$R^2 - R - \frac{3}{4} = \left(R - \frac{3}{2}\right) \left(R + \frac{1}{2}\right)$$

has the two simple roots  $R = -\frac{1}{2}$  and  $R = \frac{3}{2}$ . Therefore, the corresponding homogeneous equation has the complete solution

$$c_0(x) = k_1 \exp\left(-\frac{1}{2}x\right) + k_2 \exp\left(\frac{3}{2}x\right), \quad x \in \mathbb{R}, \quad k_1, k_2 \in \mathbb{R}.$$

Then guess on  $c_1(x) = k \exp\left(-\frac{1}{4}x\right)$ , which by insertion into the left hand side of the equation gives

$$\begin{aligned}\frac{d^2c}{dx^2} - \frac{dc}{dx} - \frac{3}{4}c &= k \left\{ \left(-\frac{1}{4}\right)^2 - \left(-\frac{1}{4}\right) - \frac{3}{4} \right\} \exp\left(-\frac{1}{4}x\right) \\ &= -\frac{7}{16}k \exp\left(-\frac{1}{4}x\right).\end{aligned}$$

This is equal to  $-7 \exp\left(-\frac{1}{4}x\right)$  for  $k = 16$ .

Since  $\exp\left(-\frac{1}{2}x\right)$  is a solution of the homogeneous equation, we change our guess to  $c_2(x) = k \cdot x \exp\left(-\frac{1}{2}x\right)$ . Then

$$\frac{dc}{dx} = k \left(-\frac{1}{2}\right) x \exp\left(-\frac{1}{2}x\right),$$

and

$$\frac{d^2c}{dx^2} = k \left(-\frac{1}{2}\right)^2 x \exp\left(-\frac{1}{2}x\right) - k \cdot \exp\left(-\frac{1}{2}x\right),$$

hence by insertion,

$$\begin{aligned}\frac{d^2c}{dx^2} - \frac{dc}{dx} - \frac{3}{4}c &= k \left\{ \frac{1}{4} + \frac{1}{2} - \frac{3}{4} \right\} x \exp\left(-\frac{1}{2}x\right) + k(-1 - 1) \exp\left(-\frac{1}{2}x\right) \\ &= -2k \exp\left(-\frac{1}{2}x\right).\end{aligned}$$

This is equal to  $-6 \exp\left(-\frac{1}{2}x\right)$  for  $k = 3$ .