

# Refrigeration: Theory And Applications

James K. Carson



Download free books at

[bookboon.com](http://bookboon.com)

James K. Carson

# Refrigeration: Theory And Applications

---

Refrigeration: Theory And Applications

1<sup>st</sup> edition

© 2013 James K. Carson & [bookboon.com](http://bookboon.com)

ISBN 978-87-403-0363-6

# Contents

<b>1</b>	<b>Introduction</b>	<b>8</b>
1.1	Importance of Refrigeration	8
1.2	A Brief History of Refrigeration	9
1.3	Scope and Outline of this Book	10
1.4	Bibliography for Chapter 1	10
	<b>Part 1: Theory</b>	<b>11</b>
<b>2</b>	<b>Thermodynamics</b>	<b>12</b>
2.1	Definitions	12
2.2	The First Law of Thermodynamics	16
2.3	The Second Law of Thermodynamics	17
2.4	Phase diagrams and refrigerant properties	22
2.5	Vapour Compression Cycles	26
2.6	Cascade and multi-stage vapour compression cycles	37
2.7	Sorption refrigeration	44
2.8	Summary of Chapter 2	47
2.9	Further Reading	48

www.sylvania.com

We do not reinvent  
the wheel we reinvent  
light.

Fascinating lighting offers an infinite spectrum of possibilities: Innovative technologies and new markets provide both opportunities and challenges. An environment in which your expertise is in high demand. Enjoy the supportive working atmosphere within our global group and benefit from international career paths. Implement sustainable ideas in close cooperation with other specialists and contribute to influencing our future. Come and join us in reinventing light every day.

Light is OSRAM



<b>3</b>	<b>Heat Transfer</b>	<b>49</b>
3.1	Modes of heat transfer	49
3.2	Steady state conduction and convection	49
3.3	Heat Exchangers	54
3.4	Transient Heat Transfer	59
3.5	Summary of Chapter 3	65
3.6	Further Reading	66
<b>4</b>	<b>Refrigerants</b>	<b>67</b>
4.1	Desirable Attributes of Refrigerants	67
4.2	Refrigerants after the Montreal and Kyoto Protocols	69
4.3	Summary of Chapter 4	71
4.4	Further Reading	71
<b>5</b>	<b>Refrigeration without a Refrigerant</b>	<b>72</b>
5.1	Evaporative cooling	72
5.2	Peltier-Seebeck effect (thermoelectric devices)	73
5.3	Magneto-Calorific Effect (Magnetic Refrigeration)	75
5.4	Thermo-acoustic effect (acoustic refrigeration)	76
5.6	Summary of Chapter 5	78
5.7	Further Reading	78



Discover the truth at [www.deloitte.ca/careers](http://www.deloitte.ca/careers)

**Deloitte.**

© Deloitte & Touche LLP and affiliated entities.



Click on the ad to read more

<b>Part 2: Applications</b>	<b>79</b>
<b>6 Chilling and Freezing</b>	<b>80</b>
6.1 Estimating Chilling times of food products	81
6.2 Estimating heat loads of food products	88
6.3 Freezing and Thawing Time Prediction	88
6.4 Summary of Chapter 6	93
6.5 Further Reading	93
<b>7 Food Refrigeration</b>	<b>95</b>
7.1 The Domestic Refrigerator	95
7.2 The Cold Chain	97
7.3 Typical examples of refrigerated facilities	98
7.4 Design Considerations	101
7.5 Refrigerated transport	104
7.6 Summary of Chapter 7	108
7.7 Further Reading	108

SIMPLY CLEVER

ŠKODA



**We will turn your CV into an opportunity of a lifetime**

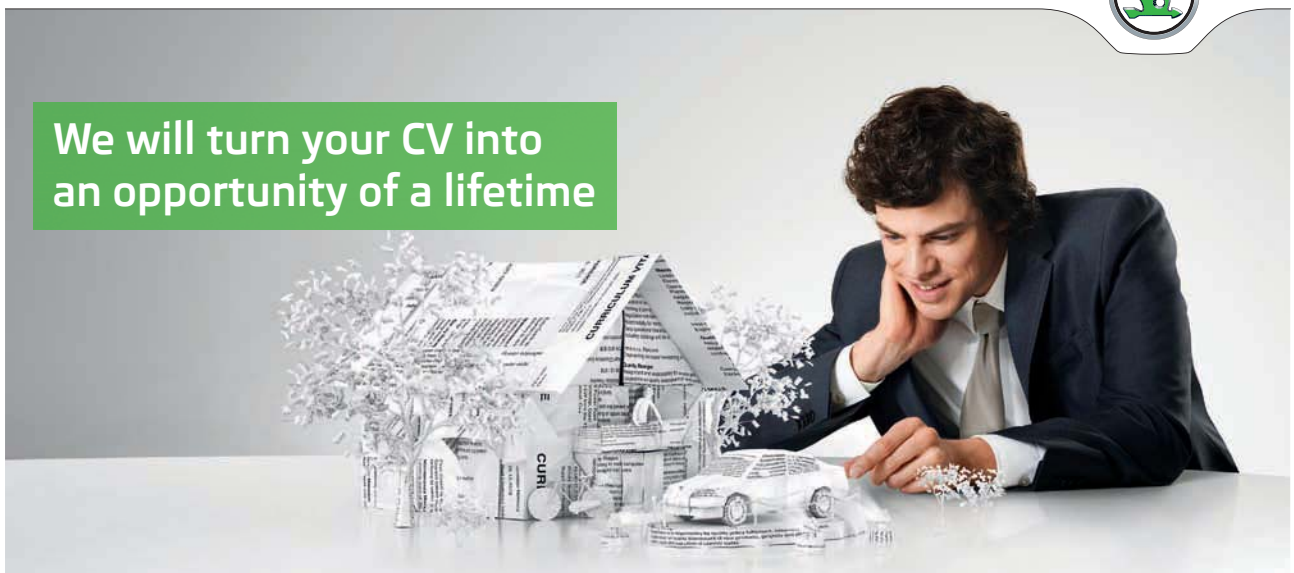

Do you like cars? Would you like to be a part of a successful brand? We will appreciate and reward both your enthusiasm and talent. Send us your CV. You will be surprised where it can take you.

Send us your CV on [www.employerforlife.com](http://www.employerforlife.com)



**Click on the ad to read more**

<b>8</b>	<b>Air Conditioning</b>	<b>110</b>
8.1	Air-conditioning Cooling Load Calculations	110
8.2	Domestic air-conditioning	113
8.3	Large-scale air-conditioning	115
8.4	Summary of Chapter 8	116
8.5	Further Reading	116
<b>9</b>	<b>Cryogenics and Gas Liquefaction</b>	<b>117</b>
9.1	Cryogenics	117
9.2	Gas Liquefaction	118
9.3	Summary of Chapter 9	119
9.4	Further Reading	119
<b>10</b>	<b>List of Symbols:</b>	<b>120</b>
<b>11</b>	<b>Appendix: Physical Properties of Refrigerant R134a</b>	<b>122</b>

I joined MITAS because  
I wanted **real responsibility**

The Graduate Programme  
for Engineers and Geoscientists  
[www.discovermitas.com](http://www.discovermitas.com)



**Month 16**

I was a construction  
supervisor in  
the North Sea  
advising and  
helping foremen  
solve problems

Real work  
International opportunities  
Three work placements



 **MAERSK**

# 1 Introduction

## 1.1 Importance of Refrigeration

For most people, certainly in the developed world, the word ‘refrigeration’ would probably evoke the image of a white or metallic-grey device in their homes which is used to keep food and beverages cool. These devices are generally reliable and low-maintenance and have a familiar, comforting quality, but do not solicit much thought or attention. However, refrigeration goes far beyond the domestic setting, or the supermarket or grocery store where ‘fridges’ are most commonly seen by the average person. The reality is that societies in the developed world depend on refrigeration to the point where it would be no exaggeration to say that many lives would be lost if all mechanical refrigerators were suddenly to fail.

In addition to keeping beer chilled, and ice cream frozen, refrigeration is vital for food supply and security, particularly for countries who import the majority of their food (more than 80% in some instances). Nature does not work according to humanity’s schedule; many fruits and vegetables are produced seasonally and refrigeration technology provides us with the ability to store perishable produce in order to balance the irregular supply with the much more steady demand. A number of countries which are significant food exporters (e.g. Australia, New Zealand, Chile and Argentina) are geographically isolated from the major food importers (particularly in Europe) and refrigeration provides the means for transporting foods large distances by the relatively slow mode of sea transport. Even within national borders, refrigerated transport is important since, in highly urbanised countries at least, much of the food produced in rural areas is destined to be consumed in the cities.

Estimates by the International Institute of Refrigeration suggest that on average 25% of food produced is wasted, due to spoilage during transportation and storage, and much of this (particularly in the Developing World) could be prevented by refrigeration. In fact there is a correlation between the number of refrigeration units per capita and rates of malnutrition. As we head further into the 21<sup>st</sup> Century, refrigeration is becoming more and more crucial to achieving the goal of feeding a growing population in a world where we have run out of room to expand our crops and pastures.

But the importance of refrigeration is not limited to food. Think of a typical hospital: many vaccines, anaesthetics, blood plasma and other forms of medication need to be kept refrigerated; some at temperatures significantly lower than that at which most food is stored. Although it has a different name, ‘air conditioning’ is mostly the same process as refrigeration. And it is not just human comfort that is at issue – in the 21<sup>st</sup> century air-conditioning is vital for keeping large computers and data-centres (i.e. file server banks) producing megawatts of heat, at operable temperatures. Modern society is so dependent on computers that failure in the air conditioning systems that cool the electronic systems that keep all our records, and control so much of the processes we rely on in everyday life, could be catastrophic.



And then there is cryogenics – the science of low temperatures. At low temperatures all sorts of interesting phenomena occur. CERN's Large Hadron Collider requires temperatures to be low in order for their experiments to be run. Refrigeration provides key support in the pursuit of knowledge about our universe and the workings of nature that we are yet to fully comprehend.

This picture of refrigeration has been painted with broad brush-strokes, but hopefully you will see that refrigeration goes beyond the mundane and commonplace role that is associated with the humble fridge, and that it truly is vital technology for our health, longevity and well-being in the modern age. So how did we get to the point where we rely on refrigeration so much? To answer, that question let us look very briefly at the development of refrigeration from ancient times. Subsequently we will adopt a definition of *refrigeration* as it is used in this book.

## 1.2 A Brief History of Refrigeration

It is difficult to put a date on the first ever usage of a cold environment to preserve food, but there is evidence to suggest that the practice is many thousands of years old. Caves appear to have been used to store food (particularly the hunter's animal prey) in primitive times, and that people in warmer climates were aware that by climbing high hills or mountains the air would be cooler and could be used for food storage. A Chinese poem of 1100 BC mentions a house where ice was stored, specifically for domestic use. In the 5<sup>th</sup> Century BC the Greek Protagoras reported that the Egyptians were capable of producing ice by placing water on their roofs when there was a clear night sky. Several hundred years later the Roman Emperor Nero Claudius is reported to have sent slaves to the mountains to fetch snow to be used specifically for cooling fruit drinks.

As time progressed, ice and snow began to be harvested and traded. During the time of the Roman Empire, citizens of Rome were supplied with ice from the Apennine Mountains. Caravans of camels were used to transport snow from the hills of Lebanon to the Caliphs in Baghdad and Damascus. By the 19<sup>th</sup> Century the trade in natural ice was intercontinental – in 1899 half a million tonnes of natural ice was imported from the United States and Norway to Great Britain.

But there is also clear evidence that these passive means of keeping food cool were not the only ones employed. An Egyptian frieze dated from some 5000 years ago depicts a man waving a fan in front of an earthenware jar, which, it is thought (with support from other sources), would have been filled with water in order to achieve cooling by evaporation. Later on, but possibly as early as the 4<sup>th</sup> Century AD in India people noticed that certain salts, such as sodium nitrate, when added to water caused cooling effects. By the 16<sup>th</sup> Century it was well-known that adding these salts to ice would result in temperatures that were lower than that of the ice or snow on its own. It was in 1550 that the first use of the expression 'to refrigerate' (essentially to 'make fresh') appears to have been used by Blas Villafranca, who published a text on the subject.

However, the real leap forward in terms of refrigeration technology came with the development of mechanical refrigeration during the 18<sup>th</sup> and 19<sup>th</sup> Centuries, which occurred largely as part of the movement to understand heat engines and the wider science of thermodynamics. People began to design devices operating in cycles using a *working fluid*, such as ammonia, to achieve cooling. Names such as Carrier and von Linde (major players in the development of refrigeration) are familiar to many today as brand names on modern refrigeration equipment. The 20<sup>th</sup> Century saw an explosion in the uptake of mechanical refrigeration, thanks to mass production and the progress in technology (interestingly CFC refrigerants, which until the end of last century were regarded as near perfect refrigerants, are often credited with a significant role in this ‘explosion’). The result, of course, is that refrigerators, air conditioners and heat pumps are common features in homes, shops, offices, hotels and other buildings all around the world.

### 1.3 Scope and Outline of this Book

This book is concerned with the active, mechanical production of ‘cold’ (note that we don’t really have an antonym for ‘heat’ in the English language). Therefore, when the term *refrigeration* is used, it is not meant to include the use of naturally occurring ‘cold’ from the environment. As a general term, refrigeration also includes air-conditioning technology; however, due to its similarity, heat pump technology will also be covered. The majority of the content of the book is concerned with devices based on the vapour compression cycle, since it is this technology that the vast majority of refrigerators, air conditioners and heat pumps employ. However, other techniques will also be covered, albeit in less detail (see Chapter 5 in particular).

The book is split into two parts. Part 1 deals with the underlying physics associated with refrigeration technology (thermodynamics and heat transfer in particular). Part 2 deals with the applications of refrigeration technology, in the fields of preservation (of biological material), human comfort and cryogenics.

The book is intended for use as a text for a third or fourth year elective paper (or possibly a taught Masters paper) for engineering students. Prior knowledge of (or at least exposure to) thermodynamics and heat transfer is assumed; however, only basic theory is covered, and some students may be capable of understanding the content without significant prior knowledge.

### 1.4 Bibliography for Chapter 1

Pearson, SF, Refrigerants Past, Present and Future, *Proceedings of the 21<sup>st</sup> International Congress of Refrigeration*, Washington DC, 2003

Thévenot, R. *A history of refrigeration throughout the world*, International Institute of Refrigeration, Paris, 1979

5th Informatory Note on Refrigeration and Food, International Institute of Refrigeration, Paris, 2009

# Part 1: Theory

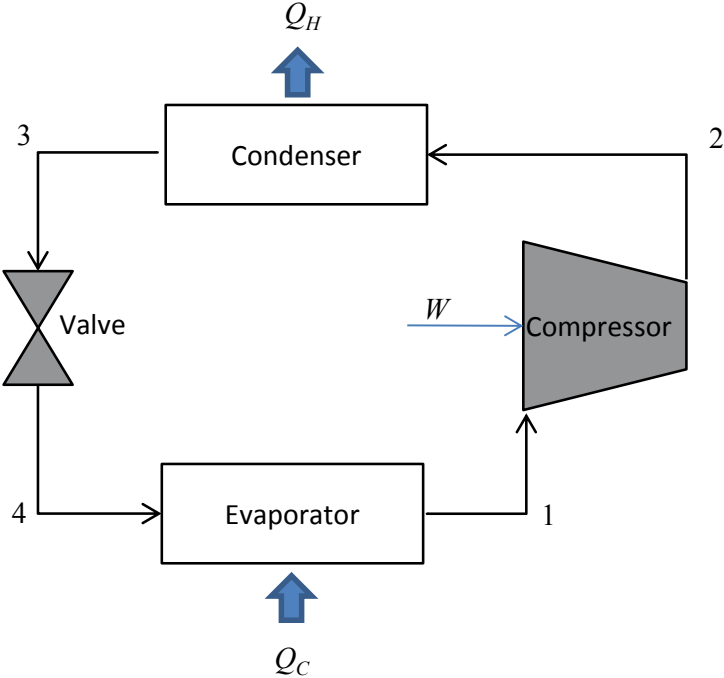

# 2 Thermodynamics

## 2.1 Definitions

It is assumed that the reader of this text is familiar with the definitions and concepts of pressure, temperature, enthalpy, entropy, heat and work (if not the reader is directed to Cengel & Boles 2007). However it is worth revising some of the important concepts of Classical Thermodynamics.

### 2.1.1 System and Surroundings

In classical thermodynamics we are typically interested in changes in, and exchanges of, energy and mass between certain bodies (e.g. a tank of water or quantity of gas etc.). To clarify discussions, we call the particular body of interest (or region of space) the *system*. The system is often (but not by necessity) contained within some physical boundary. Where the boundary of the system is such that matter (mass) is allowed to enter or leave the system, it is said to be an *open system*. Where the boundary of the system is such that mass is not allowed to enter or leave the system, but work and/or heat are allowed to be transferred across the boundary, the system is said to be a *closed system*. In the unusual case that the boundary of the system is such that neither mass nor energy (in the form of heat or work) is allowed to cross the boundary, the system is said to be an *isolated system*.

The distinction between open and closed systems is important since thermodynamic analyses of closed systems tend to be simpler, by virtue of the fact that we do not have to consider the changes in energy of a system brought about simply by the transfer of mass with its intrinsic energy into or out of the system. This is the case with the refrigerant in a refrigerator or heat pump (provided there are no leaks), and hence we only need to consider work and heat transfer effects.

Everything outside the system is known as the *surroundings*. There can be more than one system but typically we only talk about one 'surroundings'. Note that the surroundings of a system of interest may simply be one or more other system(s) in their own right. Typically we are interested in transfers between the system and its surroundings. The system and surroundings combined make up what is referred to as the *universe* (this latter definition is important when considering entropy changes).

### 2.1.2 Equilibrium

In classical thermodynamics equilibrium is a vital concept, because changes are expressed in terms of an initial state and a final state, *but changes are not considered with respect to time*. (i.e. there is no concern for rates of change with respect to time). In order for a system to be at equilibrium, all forces (or, more generally, drivers of change) acting on it need to be balanced such that there is no net change to any of the system's state variables with time.

2.1.3 State variables and path-dependent variables

Another important concept in classical thermodynamics is the concept of a state variable. To illustrate this concept, consider climbing the hill, as depicted in Figure 2.1.

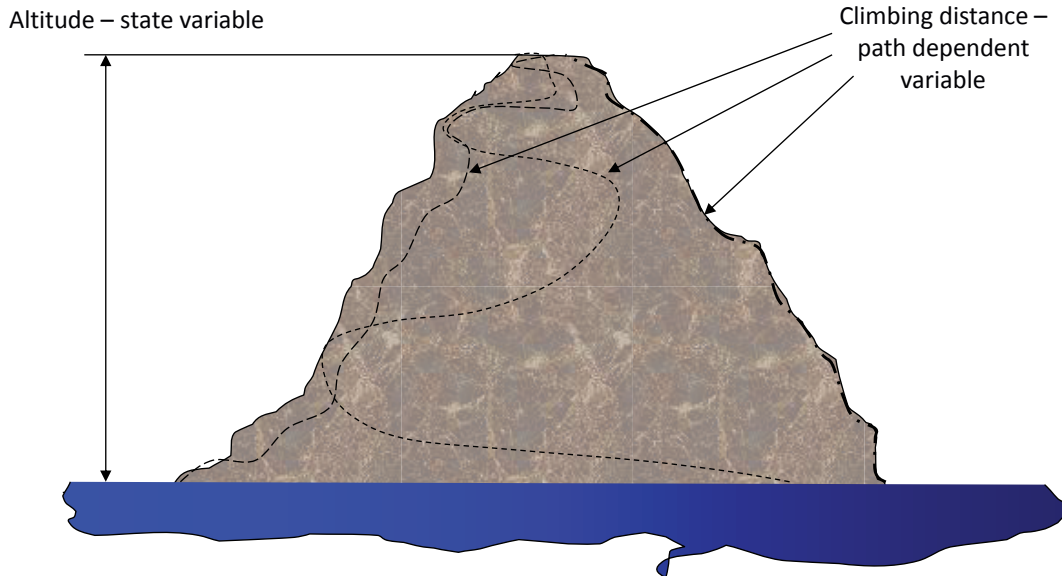

Figure 2.1: Illustration of the difference between state and path dependent variables

**ie business school**

#1 EUROPEAN BUSINESS SCHOOL  
FINANCIAL TIMES 2013

#gobeyond

**MASTER IN MANAGEMENT**

Because achieving your dreams is your greatest challenge. IE Business School's Master in Management taught in English, Spanish or bilingually, trains young high performance professionals at the beginning of their career through an innovative and stimulating program that will help them reach their full potential.

- Choose your area of specialization.
- Customize your master through the different options offered.
- Global Immersion Weeks in locations such as London, Silicon Valley or Shanghai.

*Because you change, we change with you.*

www.ie.edu/master-management | mim.admissions@ie.edu | f t in YouTube

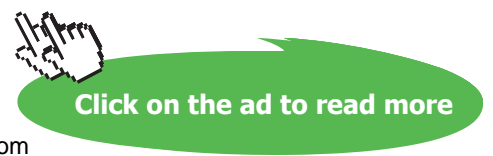

There may be a number of different trails you could follow to climb the hill, which will affect the *distance* that you travel; however, regardless of which path you take, your change in *altitude* (vertical displacement) depends only on your initial and final altitudes. In this example, the distance travelled is a *path-dependent variable*, whereas altitude is a *state variable*. In thermodynamics examples of path-dependent variables include heat and work, while examples of state variables include temperature, pressure, specific enthalpy, and specific entropy. The name ‘state’ refers to the fact that state variables characterise or describe the physical state (i.e. condition) of the system.

#### 2.1.4 Gibbs Phase Rule

You should be familiar with Gibb’s Phase Rule which allows us to determine the number of independent, intensive variables that need to be known in order for the system’s state to be specified completely:

$$F = C - N + 2 \quad (2.1)$$

Where:  $F$  is the number of degrees of freedom (i.e. the number of variables that need to be specified),  $C$  is the number of chemical components in the system and  $N$  is the number of phases in the system.

Many common refrigerants are essentially pure chemical species (i.e.  $C = 1$ ). If phase change is occurring then two phases are in equilibrium with each other (i.e.  $N = 2$ ) and hence  $F = 1$ . That is, when two species are in equilibrium (e.g. a liquid and vapour) there is only one degree of freedom, which means that if we specify one intensive state variable (e.g. temperature), then all the other intensive state variables (e.g. pressure, specific enthalpy, specific entropy) are fixed. If, however, only the liquid or vapour phases are present in the system, then we have  $N = 1$  and  $F = 2$ , and hence we need to specify two intensive state variables before all the others are fixed. This information will be useful when we analyse the performance of different refrigeration cycles later in the chapter.

#### 2.1.5 Reversibility and Irreversibility

Reversibility is yet another important concept in thermodynamics. In order for a process to be thermodynamically *reversible*, the following criteria must be met:

1. The system must be only infinitesimally removed from equilibrium at any stage of the process
2. The process must be able to be reversed at any stage of the process without leaving any impact on the surroundings (note that this second criterion is implied by the first)

Thermodynamic reversibility is more specific than simply referring to a process for which the opposite (or reverse) process is possible. Let’s illustrate from an every-day example. Consider the vertical window as depicted in Figure 2.2.

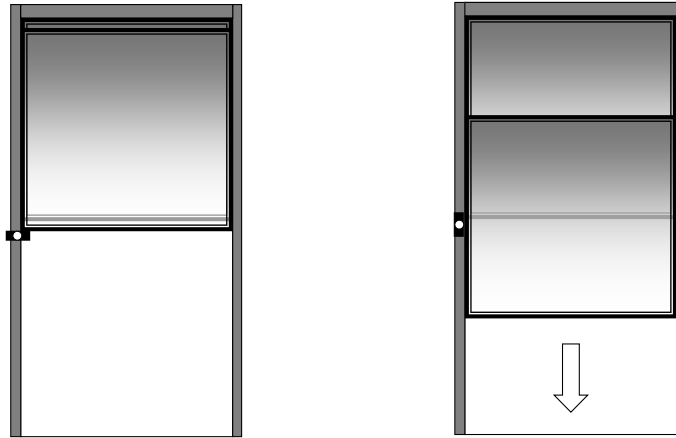

**Figure 2.2:** Closing a vertical window – irreversibly

The window is originally in its fully open position, held in place by the latch. If the latch is turned, releasing the window, it will lower itself spontaneously (probably with quite a crash!). We do not need to expend any energy in closing the window (other than turning the latch); however, we will need to do quite a lot of work to open the window (i.e. to return it to its original state).

Now consider the vertical window depicted in Figure 2.3. This time there are counterweights for the window. If it is originally in its fully open position, when we turn the latch nothing will happen; the window will not close itself spontaneously. In order for the window to be closed we will need to apply a small downward force (to overcome friction). We can halt the process halfway, and leave the window half open. We can return the window to its original position simply by applying a small upward force. When the window is fully closed, returning it to its fully open position requires much less work than the window without counterweights.

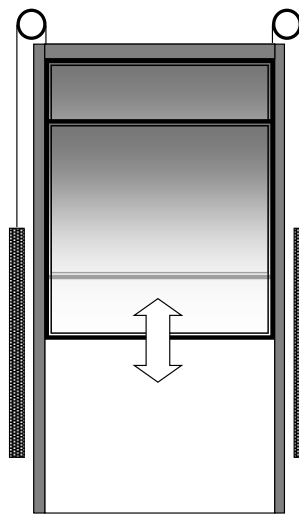

**Figure 2.2:** Closing (or opening) a vertical window – reversibly

The window example illustrates that reversible processes are not spontaneous and therefore spontaneous processes are necessarily irreversible. Although we do not provide the proof here, thermodynamically reversible processes are the most energy efficient processes possible (returning to the window illustration – in principle we could open the counter-weighted window with a little finger, whereas the un-weighted window would require both hands with a significant force). True thermodynamic reversibility cannot be attained by any real-life processes due to friction and similar factors; however, a number of real life processes approximate reversibility. Examples include equilibrium chemical reactions, isothermal heat transfer (e.g. involving phase change), and some compression processes (think of a compressing or expanding a gas by adding or removing a grain to/from a pile of sand used as the weight for the piston doing the compressing).

## 2.2 The First Law of Thermodynamics

You should be familiar with the famous First Law of thermodynamics, which states that energy is not created or destroyed by any process; rather its form is changed. Of practical value to engineers and scientists is the mathematical expression of this statement, shown below for a closed system at rest:

$$\Delta U = Q + W \quad (2.2)$$



**no.1**  
nine years  
in a row

Sydney  
Stockholm

## STUDY AT A TOP RANKED INTERNATIONAL BUSINESS SCHOOL

Reach your full potential at the Stockholm School of Economics, in one of the most innovative cities in the world. The School is ranked by the Financial Times as the number one business school in the Nordic and Baltic countries.

Visit us at [www.hhs.se](http://www.hhs.se)

STOCKHOLM SCHOOL OF ECONOMICS



(Note that the signs of  $Q$  and  $W$  in Eq. (2.2) depend on convention, but the important point to bear in mind is that work done on the system and heat transferred to it will increase  $U$ , and vice versa for work done by the system and heat transferred from it).

Most refrigeration and heat pump processes operate in a cyclic manner, periodically returning the refrigerant to a given state. We can, therefore, say that over the cycle the net change in internal energy is zero, i.e.:

$$\oint_{\text{cycle}} \Delta U = 0 \quad (2.3)$$

and therefore the first law for a closed, cyclic process can be written:

$$Q_{\text{net}} = W_{\text{net}} \quad (2.4)$$

In refrigeration and heat pump cycles work is only performed during one stage of the cycle, while heat is transferred during two stages, one at a low temperature and one at a high temperature (the temperatures are 'high' and 'low' relative to each other, rather than in absolute terms). Hence the form of the First Law that will be most useful for analysing refrigeration or heat pump cycles is:

$$W = Q_H - Q_C \quad (2.5)$$

where  $W$  is work done *on* the refrigerant, and the subscripts  $H$  and  $C$  refer to the hot (high) and cold (low) temperature heat transfer processes respectively.

## 2.3 The Second Law of Thermodynamics

### 2.3.1 Statements of the Second Law

The Second Law of Thermodynamics is perhaps slightly more abstract and harder to grasp than the First Law. To paraphrase Rudolf Clausius (1822 to 1888), the Second Law states that:

*It is impossible to construct a device operating in cyclic fashion whose sole purpose is to transfer heat from a low temperature reservoir to a higher temperature reservoir.*

At face value this statement might appear to suggest that refrigeration (which is a process having the net effect of transferring heat from a low temperature to a higher temperature) is a physical impossibility – more on this point later.

To get a mathematical expression of the Second Law, first we need to recall the definition of entropy (as used in classical thermodynamics) courtesy of Clausius:

$$\Delta S = \int \frac{Q_{rev}}{T} \quad (2.6)$$

Mathematically, the Second Law can be written as:

$$\Delta S_{universe} = \Delta S_{system} - \Delta S_{surrounding} \geq 0 \quad (2.7)$$

We can state Eq. (2.7) verbally by saying that for any process the entropy of the universe can only increase, or in the limiting case (reversible processes) can remain unchanged. The Second Law states that *the entropy of the universe can never decrease*. So how do we reconcile Eq. (2.7) with Clausius's statement? To answer this question, refer to Figure 2.4:

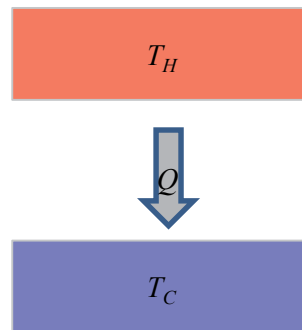

**Figure 2.4:** Heat flow between hot and cold reservoirs

A quantity of heat  $Q$  is transferred between the thermal reservoir at temperature  $T_H$  and another thermal reservoir at temperature  $T_C$  where  $T_H > T_C$  (Note that a *thermal reservoir* is a large thermal mass at an essentially uniform temperature such that adding or removing quantities of heat will have a negligible impact on the reservoir's temperature. Examples of thermal reservoirs include the atmosphere or large bodies of water such as lakes and seas).

If the heat is transferred from the high temperature reservoir to the low temperature reservoir, the entropy change for the high temperature reservoir ( $\Delta S_H$ ) is given by:

$$\Delta S_H = \frac{-Q}{T_H} \quad (2.9)$$

And similarly for the low temperature reservoir

$$\Delta S_C = \frac{Q}{T_C} \quad (2.10)$$

The total entropy change is therefore:

$$\Delta S_{universe} = \Delta S_H + \Delta S_C = \frac{-Q}{T_H} + \frac{Q}{T_C} \quad (2.11)$$

Since  $T_H > T_C$ ,  $\Delta S_H < \Delta S_C$ , and  $\Delta S_{\text{universe}}$  will be greater than 0, and therefore this process is allowable according to Eq. 2.7. By contrast, the reverse process is not permissible, which is where we get the statement that “heat only flows from hot to cold”, and demonstrates that Clausius’s statement of the Second Law is a necessary consequence of Eq. (2.7).

So then how can refrigeration be possible, if heat cannot flow from cold to hot? The answer is because the temperature of a body of mass can be raised or lowered without the transfer of heat, and this is how refrigeration works. There are a number of ways in which this can be achieved (and some of these will be discussed in Chapter 5); however, the vast majority of refrigeration and heat pump cycles in use today achieve the increase of temperature of the refrigerant by compressing it and the reduction of its temperature by expanding it adiabatically (thanks to the Joule-Thomson effect).

### 2.3.2 The Reversed Carnot Cycle and the COP

One of the key theories in the elucidation of the Second Law, was the Carnot Cycle. The Carnot Cycle is an ideal heat engine which operates according to four reversible processes: adiabatic expansion, isothermal compression, adiabatic compression, and isothermal expansion. During the first process work is produced by the system, during the second heat is absorbed by the system, during the third work is done on the system, and during the fourth heat is rejected by the system.



**#1**  
in eco-friendly  
attitude

**STUDY AT  
LINKÖPING UNIVERSITY, SWEDEN**  
RANKED AMONG TOP 50 UNIVERSITIES UNDER 50

Interested in Strategy and Management in International Organisations? Kick-start your career with a master's degree from Linköping University, Sweden.

→ **Click here!**

 **Linköping University**

Since the cycle involves only reversible processes, any Carnot engine should be able to be operated in reverse as a heat pump or refrigerator, in which case the four processes would be adiabatic expansion, isothermal expansion, adiabatic compression and isothermal compression. The reversed Carnot cycle is illustrated on a temperature versus entropy (TS) plot shown in Figure 2.5:

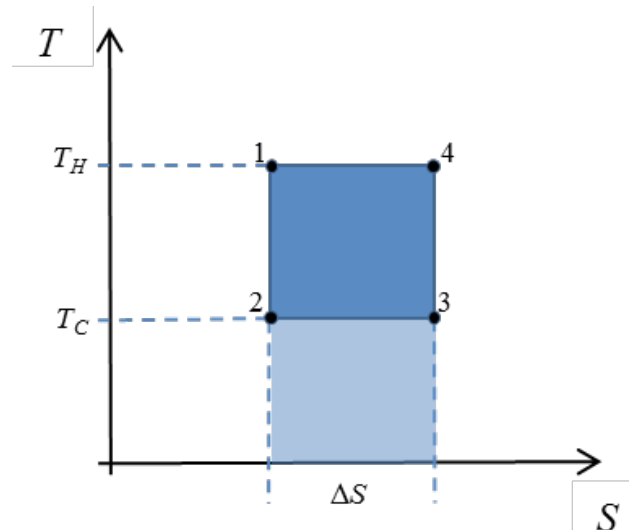

**Figure 2.5:** Reversed Carnot cycle on a temperature-entropy (T-S) plot;

The heat rejected by the system during the isothermal compression can be calculated by a rearrangement of Eq. (2.6):

$$Q_H = T_H \Delta S \quad (2.12)$$

And during the isothermal expansion the heat absorbed is:

$$Q_C = T_C \Delta S \quad (2.13)$$

The net work input to the system is given by the First Law (Eq. 2.5):

$$W = Q_H - Q_C \quad (2.14)$$

Note that the work required to drive the reversed Carnot cycle is equal to the area enclosed by the cycle (the darker shaded area in Fig. 2.5).

Combining Eqs. (2.12) to (2.14):

$$W = \Delta S (T_H - T_C) \quad (2.15)$$

In order to assess the performance of the reversed Carnot cycle we introduce the coefficient of performance (COP). For a refrigerator, where we are interested in removing heat at a low temperature the COP is defined as:

$$COP_R = \frac{Q_C}{W} \quad (2.16)$$

For a heat pump, where we are interested in the heat produced at the high temperature:

$$COP_{HP} = \frac{Q_H}{W} \quad (2.17)$$

(The COP is essentially the *efficiency* of the refrigeration or heat pump cycle; however, because ‘efficiencies’ are generally defined such that they have values between 0 and 1, and COP values are usually greater than 1, traditionally the more cumbersome term COP has been used to keep the purists happy).

Note that by substituting Eqs. (2.13 and 2.15 into Eq. 2.16) we can obtain simple expressions for the COPs of reversed Carnot cycles:

$$COP_R = \frac{Q_C}{W} = \frac{T_C \Delta S}{(T_H - T_C) \Delta S} = \frac{T_C}{T_H - T_C} \quad (2.18)$$

$$COP_{HP} = \frac{Q_H}{W} = \frac{T_H \Delta S}{(T_H - T_C) \Delta S} = \frac{T_H}{T_H - T_C} \quad (2.19)$$

Because the reversed Carnot cycle only employs reversible processes, it is the most efficient cycle possible (i.e. has the highest COP). Therefore the COPs calculated for Carnot cycle provide benchmarks for real refrigeration and heat pump cycles to be compared against.

By examining Eqs. (2.18) and (2.19) we see that the performance of the cycle is increased as we increase the target temperature ( $T_C$  for a refrigerator,  $T_H$  for a heat pump) and as we decrease the difference between the high and low temperatures. While these conclusions were derived for the idealised Carnot cycle, the conclusion is generally applicable for real refrigeration and heat pump cycles.

It is also worth noting that:

$$\begin{aligned} COP_{HP} &= \frac{T_H}{T_H - T_C} \\ &= \frac{T_H}{T_H - T_C} - \frac{T_C}{T_H - T_C} + \frac{T_C}{T_H - T_C} \\ &= \frac{T_H - T_C}{T_H - T_C} + \frac{T_C}{T_H - T_C} \\ &= 1 + COP_R \end{aligned} \quad (2.20)$$

Or, more generally:

$$\begin{aligned} COP_{HP} &= \frac{Q_H}{W} \\ &= \frac{W + Q_C}{W} \\ &= 1 + COP_R \end{aligned} \quad (2.21)$$

Hence a device (e.g. the invertible domestic heat pump described in Chapter 8) will perform better as a heat pump than as a refrigerator, when operating between any two given temperatures. The reason for this is that the ‘waste product’ of the compression process is heat (essentially equal to  $W$ ), which is included in  $Q_H$  but not in  $Q_C$ .

## 2.4 Phase diagrams and refrigerant properties

The reversed Carnot cycle involves adiabatic and isothermal compressions and expansions. Obviously there needs to be some substance that is expanded or compressed, and this substance is known as the *working fluid*, or, in the case of refrigeration specifically, the *refrigerant*. The desirable attributes of a refrigerant will be discussed in Chapter 4.



“I studied English for 16 years but...  
...I finally learned to speak it in just six lessons”  
Jane, Chinese architect

ENGLISH OUT THERE

Click to hear me talking before and after my unique course download

State variables are physical attributes of a substance, and since we can relate thermodynamic processes (including refrigeration and heat pump cycles) to changes in state variables, we need to have access to the thermodynamic data of the refrigerant in order to select an appropriate refrigerant for a given task, and to perform preliminary calculations.

The Gibbs Phase Rule tells us that if we have a pure substance we need to specify at most 2 state variables, in order for the remaining variables to be fixed. However, simply knowing the number of variables that need to be specified does not tell us what the mathematical dependencies of the remaining state variables are. Thankfully a lot of work has been performed over the years to measure, correlate and model these dependencies for a large number of working fluids. The data may then be tabulated or plotted on a chart (or, these days, entered into an electronic database). A variety of sources may be consulted for the data including the ASHRAE Handbook of Refrigeration\*, and the National Institute of Standards and Technology's internet website (<http://webbook.nist.gov>).

Thermodynamic property charts are often referred to as phase diagrams, because, typically the plots cover data over a number of different phases. In plotting a phase diagram, the choice of which variable to set on the abscissa ('x-axis') and which to set on the ordinate ('y-axis') will depend on its purpose. In the previous section the Carnot cycle was plotted on a TS or temperature entropy diagram, which was convenient because the Carnot Cycle involves isothermal and isentropic (i.e. the adiabatic compression and expansion) processes, and hence only lines parallel to an axis were required. Often the properties of water are plotted as HS (enthalpy vs. entropy) diagrams called Mollier diagrams. However, the most common plot for refrigerants is the PH (pressure vs. enthalpy) diagram, an example of which is shown in Fig. 2.6 for the refrigerant R-134a, whose chemical name is 1,1,1,2-tetrafluoroethane (if you are curious about the naming convention for refrigerants, refer to the *ASHRAE Handbook of Refrigeration*).

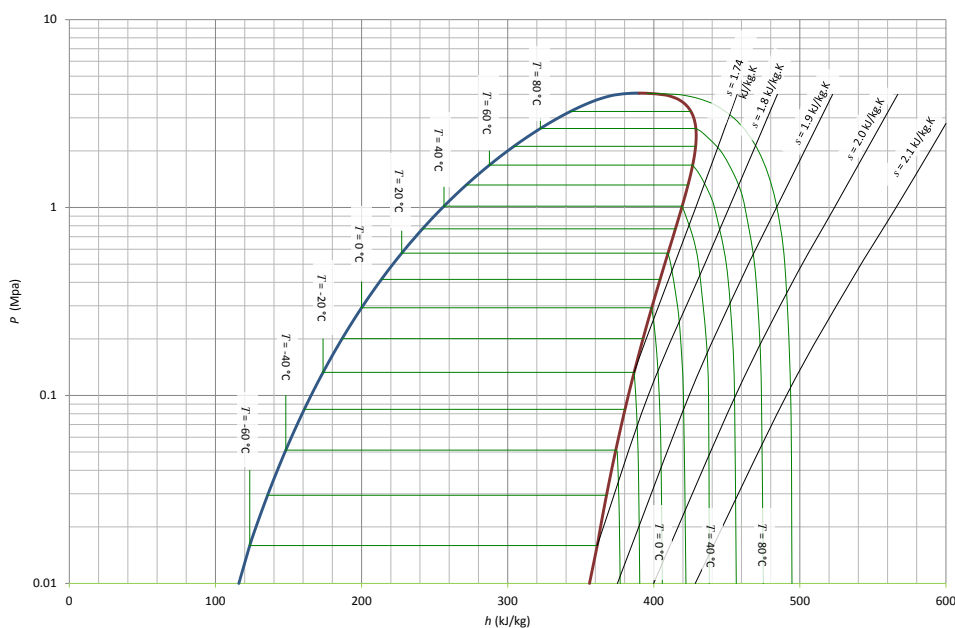

**Figure 2.6:** Pressure-enthalpy diagram for Refrigerants R-134a

(Note that a slightly larger version of this chart may be found in the Appendix – Figure A.1)

In Fig. 2.6, the blue line corresponds to the saturated liquid, the red line corresponds to the saturated vapour, the green lines correspond to isotherms (note the sharp change in the gradient of isotherms as they enter and exit the two-phase region) and the black lines correspond to lines of constant entropy ('isentropes'). The point where the saturated liquid and vapour lines meet is known as the critical point. Above the critical temperature and critical pressure of the fluid the distinction between liquid and gas is vague with density gradients rather than a sharply defined interface between phases, and the fluid is said to be *supercritical*.

Most PH diagrams include more isotherms and isentropes than are shown in Fig. 2.6, and also include lines of constant specific volume (the inverse of density). However, the more data included in the chart, the harder they are to read, so Fig. 2.6, is drawn specifically to contain sufficient data to perform the worked examples in this chapter. A larger version of Fig. 2.6 is provided in the Appendix (Figure A.1).

PH diagrams are useful for obtaining a visual representation of a refrigeration or heat pump cycle; however, since the precision of the data is limited by the size of the chart and the amount of data it contains, only the most basic calculations can be performed. For greater accuracy, tabulated data are more practical to use. The Appendix includes tabulated data for saturated R-134a and superheated R-134a (we do not often need to worry about sub-cooled liquid data, since in refrigeration cycles we do not tend to operate far away from saturation in the liquid phase).

**Example 2.1:** Use Fig. 2.6 the diagram to determine the enthalpy of saturated liquid R134a at 1 bar.

**Solution:**  $1 \text{ bar} = 10^5 \text{ Pa} = 0.1 \text{ MPa}$ . We locate 0.1 MPa on the pressure axis of Fig. 2.6 and then follow the line across to the intersection with the blue saturated liquid line, then read horizontally downward to the enthalpy axis, which yields an enthalpy of approximately  $165 \text{ kJ kg}^{-1}$ .

**Note:** Temperatures and pressures involved in plotting Fig. 2.6 are absolute; however, the data for enthalpy and entropy depend on the specification of a reference state, and hence different sources will give different values of the enthalpy of the saturated liquid R-134a at 1 bar. However, regardless of the source, any enthalpy *difference* determined from a PH diagram for a particular refrigerant should have a single result. The data in Fig. 2.6 and Table A1 were obtained from the same source, so all numbers including the enthalpy and entropy data will be the same.

**Example 2.2:** Use the data in Table A2 (Appendix) to determine the enthalpy of superheated refrigerant R-134a if the temperature is  $100 \text{ }^\circ\text{C}$  and the entropy is  $1.95 \text{ kJ kg}^{-1} \text{ K}^{-1}$ .



**Solution:** Find 100 °C in the temperature column in Table A2 and then read horizontally across until you come to the entry closest to  $1.95 \text{ kJ kg}^{-1} \text{ K}^{-1}$ , which occurs in the  $P = 0.6 \text{ MPa}$  section of the table. Then read the enthalpy value in the neighbouring column, i.e.  $487.6 \text{ kJ kg}^{-1}$ .

**Example 2.3:** Calculate the enthalpy difference between saturated liquid R134a at 40 °C and superheated R134a at 0.5 MPa and the same temperature.

**Solution:** This problem can be solved either by using Fig. 2.6 or by using Tables A1 and A2. However, since the point on the saturation curve has been specified in terms of its temperature, less interpolation or rounding will be required using the tables, since the independent variable in Table A1 is temperature (if the saturated liquid pressure was supplied then Fig. 2.6 might have been simpler to use). Let  $h_1$  refer to the specific enthalpy of the saturated liquid and  $h_2$  refer to the enthalpy of the superheated vapour. From the ' $h_f$ ' column in Table A1 at 40 °C,  $h_1 = 256.4 \text{ kJ kg}^{-1}$ ; from Table A2 at 40 °C and 0.5 MPa  $h_2 = 430.6 \text{ kJ kg}^{-1}$ . The difference is:

$$\Delta h = h_2 - h_1 = 430.6 - 256.4 = 174.2 \text{ kJ kg}^{-1}.$$

Excellent Economics and Business programmes at:



university of  
 groningen



“The perfect start  
 of a successful,  
 international career.”

**CLICK HERE**  
 to discover why both socially  
 and academically the University  
 of Groningen is one of the best  
 places for a student to be

[www.rug.nl/feb/education](http://www.rug.nl/feb/education)

## 2.5 Vapour Compression Cycles

Can we implement the reversed Carnot cycle in real life? There are, in fact, a number of hurdles that so far have prevented anyone from developing a genuine, practical Carnot refrigerator or heat pump. First of all, in order to achieve the isothermal processes, we would like to operate the cycle within the two-phase region of the refrigerant (i.e. under the saturation curves in Fig. 2.6) so that heat exchange causes phase-change rather than change in sensible heat. However, it is very difficult to manufacture turbines and particularly compressors that will cope with two-phase flows. If we operate in a single-phase region (most likely the gaseous region), our expansion and compression processes can, in principle approach reversibility, with practical mechanical designs; however, it is difficult to achieve the isothermal processes. So where should we make the compromise?

### 2.5.1 Ideal vapour compression cycles

The most commonly used refrigeration cycle is known as the vapour-compression cycle, and accounts for roughly 95% of the world's mechanical refrigerators and heat pumps. The ideal vapour compression cycle is illustrated in Fig. 2.7 on TS and PH diagrams, along with a schematic of the hardware. It consists of four processes: isentropic vapour compression, isobaric sub-cooling and condensation, isenthalpic liquid expansion, and isothermal (and isobaric) evaporation. As much as possible, the heat transfer processes occur within the two-phase region, in order to benefit from the efficiency of isothermal processes. Unlike the reversed Carnot cycle, however, the compression process occurs outside the two-phase region which causes the temperature of the refrigerant to rise significantly above the condensation temperature. This is done to avoid two-phase flow that would damage the compressor. The other key difference between the ideal vapour compression cycle and the reversed Carnot cycle is that we do not attempt to recover work during the expansion process, and simply throttle the refrigerant adiabatically. However, the adiabatic throttling causes some of the refrigerant to evaporate, reducing the quantity of heat that can be absorbed.

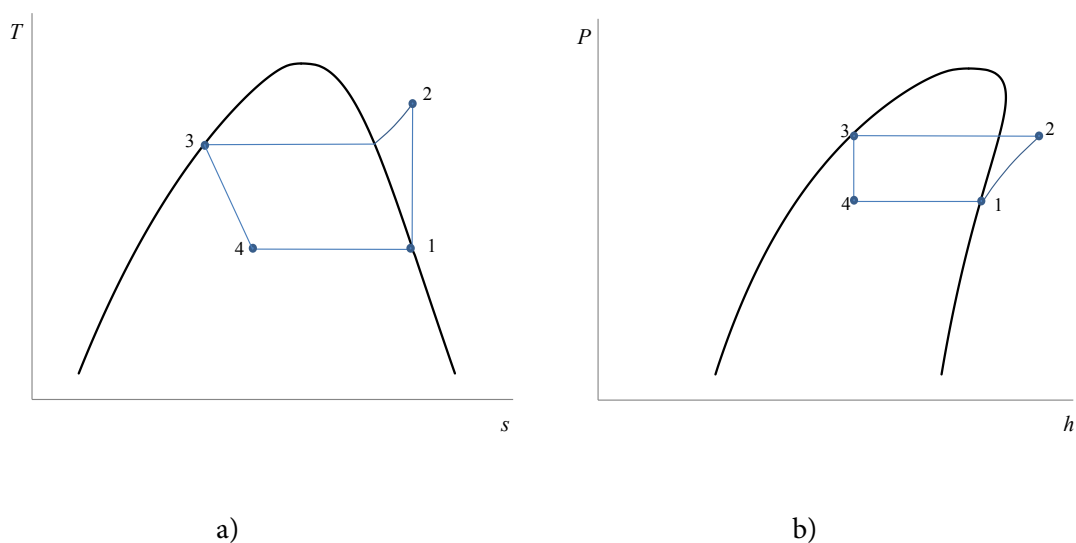

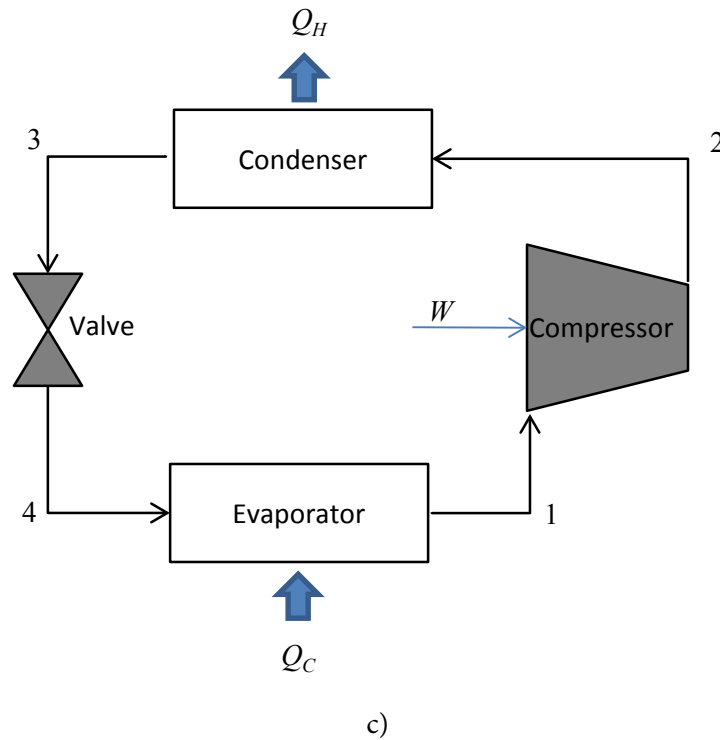

**Figure 2.7:** Ideal vapour-compression cycle: a) T-S diagram, b) P-H diagram, c) schematic

In practical refrigerators, PH diagrams are generally preferred to TS diagrams for plotting the cycle. By plotting an ideal-vapour compression cycle on a PH diagram we can perform relatively straightforward estimates of work, heat and COPs of the cycle. The work ( $W$ ) required to drive the cycle is equal to the enthalpy change of the refrigerant during the compression process, i.e. the work is equal to the enthalpy change between points 1 and 2 in Fig. 2.8. The heat absorbed by the refrigerant in the evaporator is equal to the difference in enthalpy between points 1 and 4 and the heat rejected ( $Q_H$ ) by the refrigerant in the condenser is equal to the difference in enthalpy between points 2 and 3. Once we know  $W$ ,  $Q_C$  and  $Q_H$  we are able to calculate  $COP_R$  and  $COP_{HP}$  using Eq. 2.16 or Eq. 2.17.

**Example 2.4:** Consider the ideal vapour compression cycle using R-134a as the refrigerant, and operating with a condenser temperature of  $40\text{ }^\circ\text{C}$  and an evaporator temperature of  $-20\text{ }^\circ\text{C}$ , as shown in Fig. 2.8. Calculate the amount of cooling ( $Q_C$ ) and the work ( $W$ ) input required.

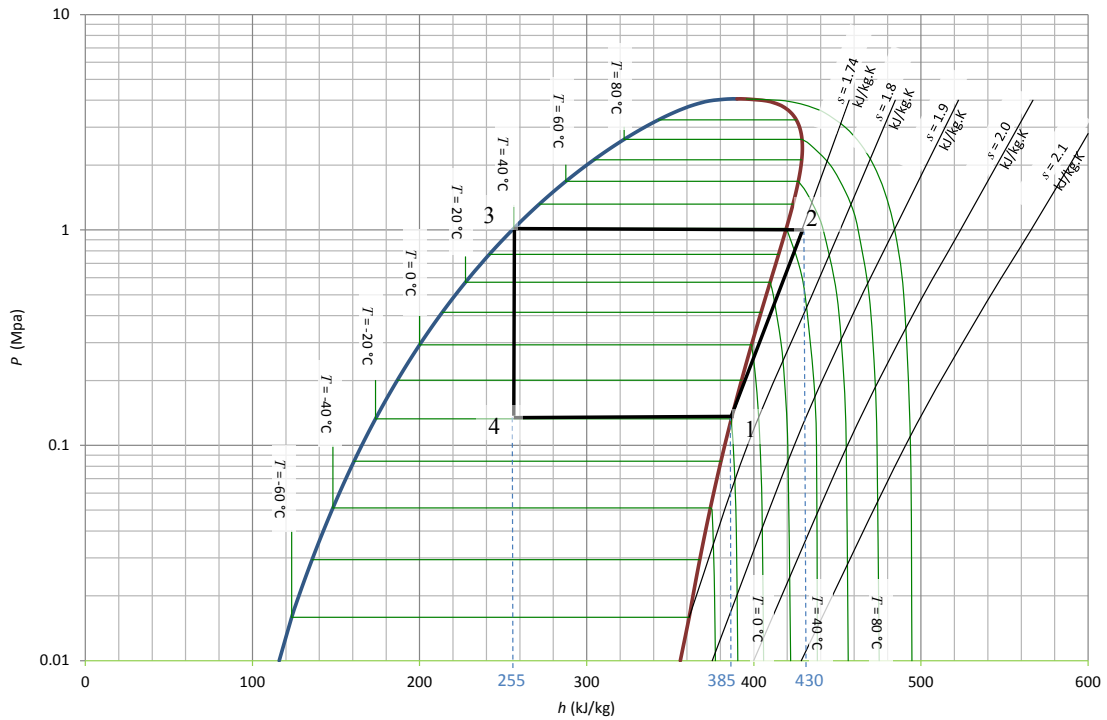



Figure 2.8: Refrigeration cycle based on R-134a for Examples 2.4 and 2.5



In the past four years we have drilled

# 89,000 km

That's more than **twice** around the world.

**Who are we?**  
We are the world's largest oilfield services company<sup>1</sup>. Working globally—often in remote and challenging locations—we invent, design, engineer, and apply technology to help our customers find and produce oil and gas safely.

**Who are we looking for?**  
Every year, we need thousands of graduates to begin dynamic careers in the following domains:

- Engineering, Research and Operations
- Geoscience and Pettechnical
- Commercial and Business

**What will you be?**



## Schlumberger

<sup>1</sup>Based on Fortune 500 ranking 2011. Copyright © 2015 Schlumberger. All rights reserved.



**Solution:** The amount of heat removed is equal to the difference in enthalpy of the refrigerant between the inlet and the outlet of the evaporator, i.e. the difference in enthalpy between State 1 and State 4. The specific enthalpy at State 1 can be obtained from Figure 2.8 by reading the 'x-coordinate' of point 1, i.e.  $h_1 = 385 \text{ kJ kg}^{-1}$ . Likewise  $h_4 = 255 \text{ kJ kg}^{-1}$ . Hence:

$$Q_C = h_1 - h_4 = 385 - 255 = 130 \text{ kJ kg}^{-1}$$

Similarly, the amount of work required is equal to the difference in enthalpy between the inlet and the outlet of the compressor, i.e.:

$$W = h_2 - h_1 = 430 - 385 = 45 \text{ kJ kg}^{-1}$$

Once we know  $Q_C$  and  $W$ , we can determine  $Q_H$  by using the First Law:

$$Q_H = Q_C + W = 130 + 45 = 175 \text{ kJ kg}^{-1}$$

Alternatively we could have read it from the chart:

$$Q_H = h_2 - h_4 = 430 - 255 = 175 \text{ kJ kg}^{-1}$$

**Example 2.5:** For the cycle depicted in Fig. 2.8 calculate  $COP_R$  and the mass flow-rate of refrigerant that would be required to achieve 2 kW of cooling.

**Solution:** The  $COP_R$  can be determined easily using Eq. 2.16 and the results from Example 2.4:

$$COP_R = \frac{Q_C}{W} = \frac{h_1 - h_4}{h_2 - h_1} = \frac{130}{45} = 2.9$$

In order to calculate the mass flow-rate of refrigerant required we recognise that the enthalpy, heat and work data that we have been using so far have units of  $\text{kJ kg}^{-1}$ . We want to know what mass *flow*-rate will give us heat *flow* with units of kW (i.e.  $\text{kJ s}^{-1}$ ). This should immediately suggest the following relationship:

$$\dot{W} \left( \frac{\text{kJ}}{\text{s}} \right) = \dot{m} \left( \frac{\text{kg}}{\text{s}} \right) W \left( \frac{\text{kJ}}{\text{kg}} \right)$$

Rearranging, we can solve for  $\dot{m}$  :

$$\dot{m} = \frac{\dot{W}}{W} = \frac{2}{130} = 0.0154 \text{ kg s}^{-1}$$

**Example 2.6:** An ideal vapour compression cycle using R-134a operates with a suction pressure of 0.2 MPa and a discharge pressure of 1.0 MPa. Using the thermodynamic property tables for R134a in the Appendix calculate: a) the evaporator and condenser temperatures, b) the temperature at the compressor discharge, c)  $COP_{HP}$

**Solution:** The ‘suction’ pressure refers to the pressure of the refrigerant at the inlet of the compressor, which corresponds to the pressure at States 1 and 4 in Fig. 2.7b. The ‘discharge’ pressure refers to the pressure of the refrigerant at the outlet of the compressor, which corresponds to the pressure at States 2 and 3.

a) Since States 1 and 3 lie on the saturation line, there is only one degree of freedom, so if we know one state variable (pressure, in this case) we can use Table A1 to find all the other state variables. Figure 2.7b shows that the State 1 is at the evaporator temperature, and State 3 is at the condenser temperature. From Table A1, the temperature of saturated R134a at 0.2 MPa (i.e.  $T_1$ , the evaporator temperature) is  $-10^\circ\text{C}$ . The temperature of saturated R134a at 1.0 MPa (i.e.  $T_3$ , the condenser temperature) is  $40^\circ\text{C}$ .

b) When the refrigerant exits the compressor it is in the superheated state (see Figures 2.7a and 2.7b), and therefore it has two degrees of freedom, and a variable in addition to the pressure needs to be specified in order for the state to be completely defined. In the case of the ideal vapour-compression cycle, we have assumed perfect, *isentropic compression*, i.e. the entropy of the refrigerant at the compressor discharge is assumed to be the same as the entropy at the suction, hence  $s_1 = s_2$  (this is shown in Figure 2.8 where the pathway between States 1 and 2 lies along an isentrope). Since State 1 is completely defined by specifying one state variable, we can determine  $s_1$  from Table A1 by finding the value in the ‘ $s_g$ ’ column which corresponds to  $P_1$  (i.e. 0.2 MPa), hence  $s_2 = s_1 = 1.73 \text{ kJ kg}^{-1} \text{ K}^{-1}$ .

To determine the temperature at State 2, we need to find the temperature which corresponds to a pressure of 1.0 MPa and an entropy of  $1.73 \text{ kJ kg}^{-1} \text{ K}^{-1}$  in Table A2. Locating the columns under the ‘ $P = 1.0 \text{ MPa}$ ’ heading in Table A2 we see that when  $s = 1.73 \text{ kJ kg}^{-1} \text{ K}^{-1}$  the refrigerant temperature is  $45^\circ\text{C}$ , i.e.  $T_2 = 45^\circ\text{C}$ .

c) To calculate  $COP_{HP}$ , we observe that for an ideal vapour-compression cycle:

$$COP_{HP} = \frac{Q_H}{W} = \frac{h_2 - h_3}{h_2 - h_1}$$

Since States 1 and 3 lie on the saturation curve, we can read  $h_1$  from the saturated *vapour* column ( $h_g$ ) of Table A1 when  $P = 0.2$  MPa, i.e.  $h_1 = 392.7$  kJ kg<sup>-1</sup>, and  $h_3$  from the saturated *liquid* column ( $h_f$ ) of Table A1 when  $P = 1.0$  MPa, i.e.  $h_3 = 256.4$  kJ kg<sup>-1</sup>. In the solution to part b) of this problem we determined that  $s_2 = 1.73$  kJ kg<sup>-1</sup> K<sup>-1</sup> in addition to  $P_2$  being given as 1.0 MPa. Therefore we can obtain  $h_2$  by locating the enthalpy value next to the  $s = 1.73$  kJ kg<sup>-1</sup> K<sup>-1</sup> entry in the ' $P = 1.0$  MPa' heading of Table A2, i.e.  $h_2 = 425.4$  kJ kg<sup>-1</sup>.

Hence:

$$COP_{HP} = \frac{h_2 - h_3}{h_2 - h_1} = \frac{425.4 - 256.4}{425.4 - 392.7} = \frac{169.0}{32.7} = 5.2$$

**Note:**  $COP_R$  can be calculated very simply from  $COP_{HP}$  by apply Eq. 2.20:

$$COP_R = COP_{HP} - 1 = 4.2$$

## American online

# LIGS University

is currently enrolling in the  
Interactive Online **BBA, MBA, MSc,**  
**DBA and PhD** programs:

- ▶ enroll **by September 30th, 2014** and
- ▶ **save up to 16%** on the tuition!
- ▶ pay in 10 installments / 2 years
- ▶ Interactive **Online education**
- ▶ visit [www.ligsuniversity.com](http://www.ligsuniversity.com) to find out more!

**Note:** LIGS University is not accredited by any nationally recognized accrediting agency listed by the US Secretary of Education. More info [here](http://www.ligsuniversity.com).





Click on the ad to read more

### 2.5.2 Practical vapour compression cycles

In the previous section we studied the ideal vapour compression cycle, in which the evaporation and condensation processes occurred isobarically, the compression occurred isentropically, and the expansion occurred adiabatically. In addition, it was assumed that the refrigerant was in the saturated vapour state when it entered the compressor, and in the saturated liquid state at the start of the expansion process. In real vapour-compression devices none of these assumptions is likely to be entirely accurate, and it is worth considering factors which prevent real vapour-compression devices from operating ideally.

*Non-isentropic compression process:* only a truly reversible compression process is isentropic (i.e. 100% efficient). In practice the compression process has an efficiency which is usually greater than 80% of the truly isentropic process.

*Non-isobaric operation:* the reader should also bear in mind that in refrigeration applications larger than the domestic setting, there may be a significant length of piping between the evaporator and the compressor, and the condenser and the expansion valve. Most systems also have a refrigerant filter/dryer in the line to prevent solid particles or water droplets entering and damaging the compressor. Friction between the refrigerant and the tubing, fittings and manifolds which contain it, along with bends, expansions and restrictions all serve to reduce the pressure of the refrigerant as it passes through the system.

*Condition of the refrigerant entering the compressor:* in practice, the risk of having liquid droplets in the compressor means that measures are taken to ensure that all the refrigerant has evaporated before it enters the compressor, which often means that it is super-heated slightly. In practice this is often achieved with the use of an *accumulator*, a simple device which uses gravity to separate vapour from any liquid.

*Condition of the refrigerant entering the expansion valve:* although expansion valves are not damaged by two-phase flow, it is difficult in practice to control the condensation process such that the refrigerant is a saturated liquid as it enters the expansion valve. Additionally, it is reasonably common practice to charge the system with an excess of refrigerant as a safety margin, to prevent poor performance or damage caused by too little refrigerant in the system (especially given that refrigerant may be lost from the system due to leakage). The excess refrigerant is usually stored in a device known as a *receiver*, which is commonly drum-shaped. For this reason, the refrigerant is usually sub-cooled when it enters the expansion valve.

*Adiabatic (isenthalpic) expansion process:* a well-insulated valve should produce an expansion that is very close to being truly isenthalpic; however, if there is no insulation around the valve, the refrigerant will absorb heat before it enters the evaporator, thereby reducing the cooling capacity of the system.

Figure 2.9 Shows a PH plot of a more realistic vapour compression cycle superimposed on the ideal vapour compression cycle shown in Figure 2.7b. The two cycles (realistic and ideal) have the same suction and discharge pressures. The following implications of the differences in the realistic and ideal cycles may be observed:



- The effects of the non-isentropic compression process are seen in the fact that compression pathway of the realistic cycle proceeds to the right of the pathway of the ideal compression process, and hence more work is required to achieve the same compression (i.e.  $h_2 - h_1$  for the realistic process is greater than it is for the ideal process)
- The non-isobaric nature of the passage of the refrigerant between the compressor and expansion valve mean that the average temperature in the condenser of the realistic system is lower than in the ideal system, and conversely the average temperature in the evaporator of the realistic system is higher than in the ideal system. This means that the compressor of the realistic system will need to have a higher compression ratio (i.e. will need to do more work) than the compressor in the ideal system to operate between the same load and ambient temperatures
- A well-insulated expansion valve should, in principle, approximate isenthalpic expansion; however, a poorly insulated valve will result in a reduced  $COP_R$ , since it reduces the amount of liquid refrigerant entering the evaporator, and hence reduces the enthalpy of vaporisation available for heat absorption. This can be seen in Figure 2.9a: the refrigerant passing through a well-insulated valve will follow the path from 3b to 4; whereas refrigerant passing through an un-insulated valve will follow the path from 3b to 4'. Clearly  $(h_{1a} - h_4)$  is greater than  $(h_{1a} - h_{4'})$ .

.....Alcatel-Lucent 

[www.alcatel-lucent.com/careers](http://www.alcatel-lucent.com/careers)

What if you could build your future and create the future?

One generation's transformation is the next's status quo. In the near future, people may soon think it's strange that devices ever had to be "plugged in." To obtain that status, there needs to be "The Shift".

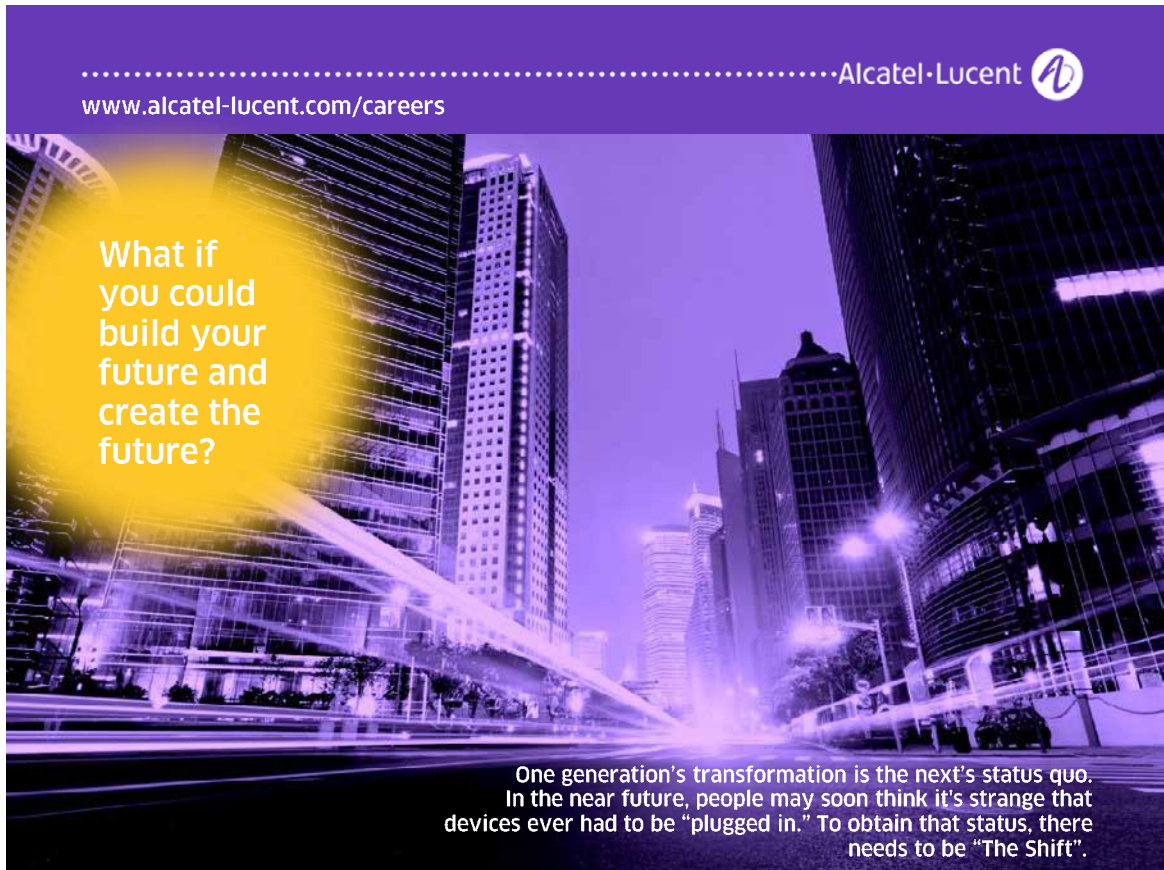

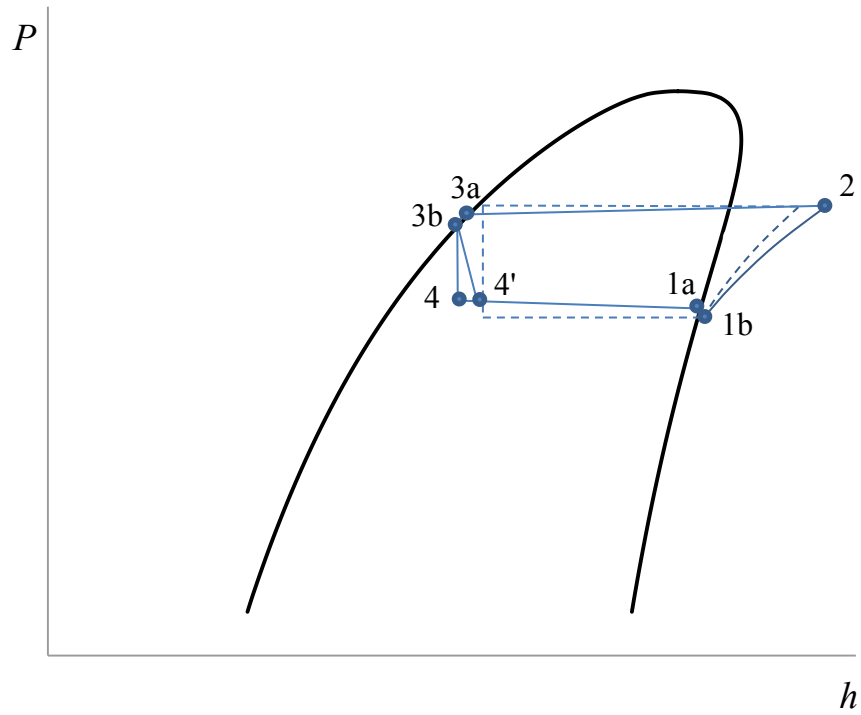

a)

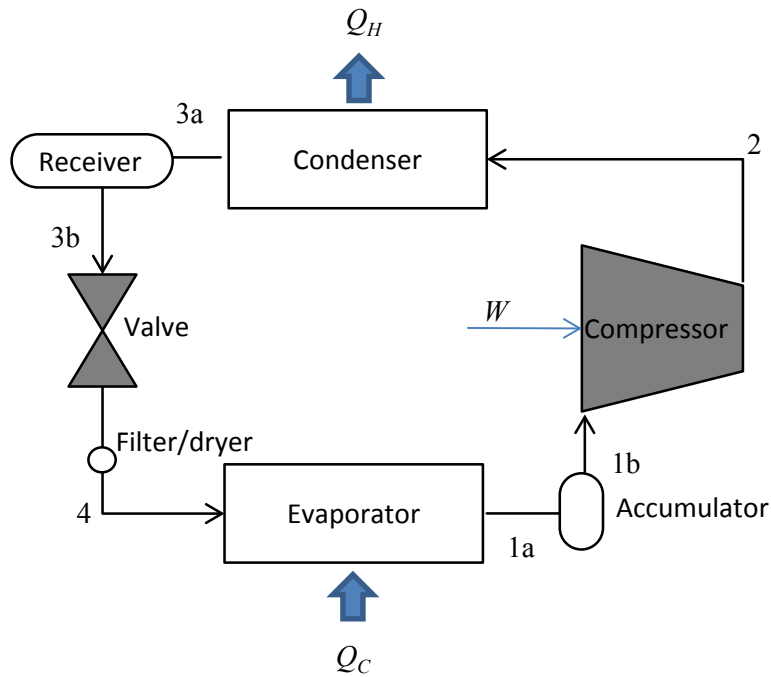

b)

**Figure 2.9:** a) Comparison of realistic (solid line) and ideal (dashed line) vapour compression cycles operating between the same suction and discharge pressures; b) schematic of realistic refrigeration apparatus with accumulator, receiver and filter-dryer

**Example 2.7:** A real vapour-compression refrigeration cycle operates with a suction pressure of 0.2 MPa and a compression ratio of 5. The refrigerant enters the compressor close to saturation and exits at 50 °C. At the start of the expansion process it is essentially saturated at 36 °C. Calculate:

a) isentropic efficiency of the compression process, where the isentropic efficiency is defined (with reference to figure 2.9b) by:

$$\eta = \frac{W_{isentropic}}{W_{actual}} = \frac{h_{isentropic} - h_{1b}}{h_2 - h_{1b}} \quad (2.22)$$

b) the  $COP_R$ , assuming that the system is sufficiently well-insulated that the only significant heat absorption occurs in the evaporator.

c) the cooling capacity of the system under these conditions if the refrigerant flow-rate is 0.05 kg s<sup>-1</sup>.

**Solution:** for this exercise it is most convenient to use the refrigerant property tables A1 and A2; however, it may be helpful for the reader to refer to Figure 2.9 to identify which states and processes are being discussed.

a) In order to calculate the isentropic efficiency using Eq. 2.22 we need to determine  $h_{1b}$ ,  $h_2$  and  $h_{isentropic}$ . Since the information given is that the refrigerant enters the compressor essentially as a saturated gas (i.e. there is negligible difference between  $h_{1a}$  and  $h_{1b}$ ) we can determine  $h_{1b}$  from finding the enthalpy of the saturated vapour at 0.2 MPa from Table A1, which is 392.7 kJ kg<sup>-1</sup> K<sup>-1</sup>. The compression ratio of 5 means that the outlet pressure is 1.0 MPa, and since the outlet temperature was given as 50 °C, we have the two state variables necessary for determining the state of the superheated refrigerant using Table A2, i.e.  $h_2 = 430.9$  kJ kg<sup>-1</sup> K<sup>-1</sup>.

$h_{isentropic}$  is the enthalpy of the refrigerant that would have resulted from an isentropic compression, and so we can determine its value by determining the entropy of the refrigerant at the inlet and using that entropy along with the exit pressure to determine  $h_{isentropic}$  from Table A2 (the same as for the calculation of  $h_2$  in Example 2.6c), i.e.  $s_{1a} = s_{1b} = 1.73$  kJ kg<sup>-1</sup> K<sup>-1</sup> (from Table A1 at 0.2 MPa), and therefore  $h_{isentropic} = 425.4$  kJ kg<sup>-1</sup> (from Table A2 with  $s = 1.73$  kJ kg<sup>-1</sup> K<sup>-1</sup> and  $P = 1.0$  MPa)

Hence:

$$\eta = \frac{h_{isentropic} - h_{1b}}{h_2 - h_{1b}} = \frac{425.4 - 392.7}{430.9 - 392.7} = 0.86 = 86\%$$

b) We can calculate  $COP_R$  in this example from:

$$COP_R = \frac{Q_C}{W_{actual}} = \frac{h_{1a} - h_4}{h_2 - h_{1b}}$$

Having determined  $h_{1a}$  and  $h_2$  in part a), and given that there is negligible difference between  $h_{1a}$  and  $h_{1b}$  it remains for us to determine  $h_4$ . Although State 4 lies within the saturation region, we cannot know its enthalpy simply from its temperature and/or pressure, without knowing what fraction of the refrigerant is in the liquid state, and what fraction is vapour. If we plotted the cycle accurately on a P-H or T-S diagram, we could use the Lever rule to estimate this fraction; however, since the problem states that the system is well insulated, it is reasonable to assume that the expansion occurs isenthalpically, and hence that  $h_4 = h_{3b}$ .  $h_{3b}$  is the enthalpy of the refrigerant at the start of the expansion process, which was given as saturated liquid at 36 °C, so  $h_{3b} = h_4 = 250.5 \text{ kJ kg}^{-1} \text{ K}^{-1}$  (from Table A1). Hence:

$$COP_R = \frac{h_{1a} - h_4}{h_2 - h_{1b}} = \frac{392.7 - 250.5}{430.9 - 392.7} = 3.7$$



**Maastricht University**

*Leading in Learning!*

**Join the best at  
the Maastricht University  
School of Business and  
Economics!**

**Top master's programmes**

- 33<sup>rd</sup> place Financial Times worldwide ranking: MSc International Business
- 1<sup>st</sup> place: MSc International Business
- 1<sup>st</sup> place: MSc Financial Economics
- 2<sup>nd</sup> place: MSc Management of Learning
- 2<sup>nd</sup> place: MSc Economics
- 2<sup>nd</sup> place: MSc Econometrics and Operations Research
- 2<sup>nd</sup> place: MSc Global Supply Chain Management and Change

Sources: Keuzegids Master ranking 2013; Elsevier 'Beste Studies' ranking 2012; Financial Times Global Masters in Management ranking 2012

**Maastricht University is the best specialist university in the Netherlands**  
(Elsevier)

**Visit us and find out why we are the best!**  
**Master's Open Day: 22 February 2014**

[www.mastersopenday.nl](http://www.mastersopenday.nl)



Click on the ad to read more

c) Calculating the cooling capacity of this refrigeration system under these conditions is straight-forward:

$$\dot{Q}_C = \dot{m}Q_C = \dot{m}(h_{1a} - h_4) = 0.04 \times (392.7 - 250.5) = 5.7 \text{ kW}$$

**Note:** Example 2.7 was essentially the more realistic version of the ideal scenario of Example 2.6. In Example 2.6 and  $COP_{R,ideal}$  was 4.2 and  $COP_{R,realistic}$  calculated in Example 2.7 was 3.7, which illustrates the effect irreversibilities have on performance. However, it should be pointed out that had we calculated the COP based on the total power drawn by the system it would have been lower, since power is required to run the control system and typically fans on one or both of the heat exchangers.

## 2.6 Cascade and multi-stage vapour compression cycles

The performance of an ordinary vapour compression cycle can be improved in a number of ways, at the expense of extra capital costs. Eq. 2.23 shows the work required for an adiabatic (isentropic) compression process:

$$w = \frac{RT_1}{\gamma - 1} \left[ \left( \frac{P_2}{P_1} \right)^{\frac{\gamma-1}{\gamma}} - 1 \right] \quad (2.23)$$

Where R is the Universal Gas Constant, and  $\gamma$  is the ratio of specific heat capacity at constant pressure to the specific heat capacity at constant volume.

Eq. 2.23 reveals that the work is required is directly proportional to the suction temperature (the temperature of the gas as it enters the compressor) and is also proportional to the compression ratio. Since the suction temperature will be set by the desired temperature in the evaporator, the single most effective way to reduce the work requirement for a given refrigeration load is to divide the compression process into stages with intercooling between stages.

### 2.6.1 Cascade refrigeration

Consider the ideal, single-stage vapour compression cycle shown by the dotted black line in Figure 2.10a (path 1→2'→7→4'). In this case the condensation and evaporation temperatures (and hence pressures) are relatively far apart and the liquid fraction of refrigerant which enters the evaporator is relatively low (hence the heat absorption potential is also relatively low). Now consider a modification to the single-stage vapour compression cycle as shown schematically in Figure 2.10b. In this modified refrigeration system, there are actually two cycles operating in two different pressure (and hence temperature) ranges.

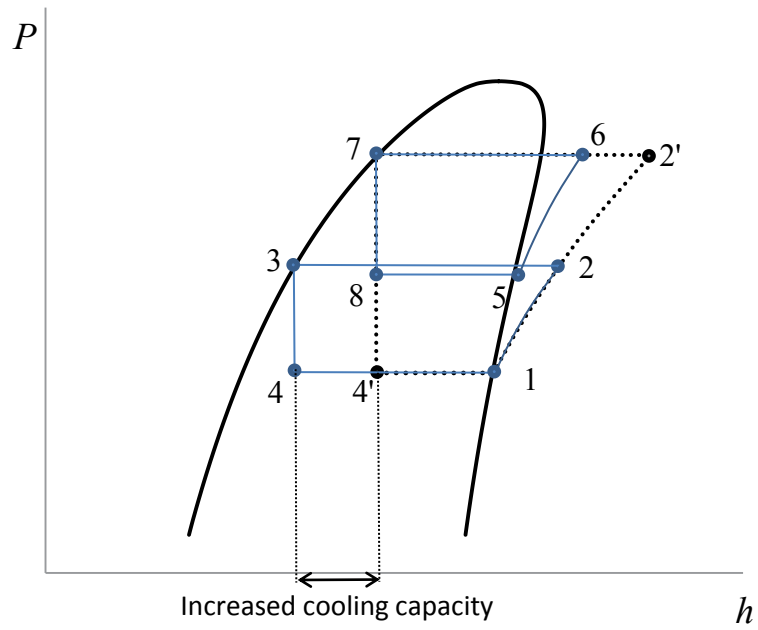

a)

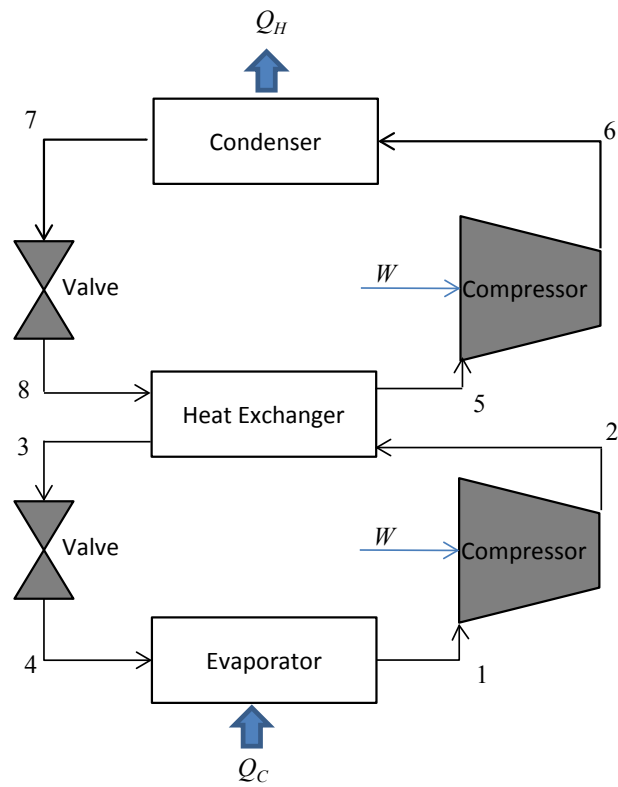

b)

**Figure 2.10:** Cascade refrigeration system

The heat exchanger that connects the two cycles serves as the evaporator for the high pressure cycle (depicted by the solid blue line following the path 5→6→7→8) and the condenser for the low pressure cycle (depicted by the solid blue line following the path 1→2→3→4).

The arrangement shown in Figure 2.10 is known as a cascade of refrigeration cycles, or *cascade refrigeration*. The advantages of cascade refrigeration over a single-stage cycle is that there is greater cooling potential (i.e.  $\Delta Q_C = h_{4'} - h_4$ ) when operating between the same condensation and evaporation temperatures, and for a given cooling load the compression work will be lower. This means that the COP of cascade refrigerators will be higher than single-stage refrigerators operating between the same temperatures. The penalty of the improved performance, though, is in more equipment and hence higher capital costs.

In addition to offering greater efficiency than single-stage refrigeration, cascade refrigeration will be able to perform some refrigeration tasks that single-stage refrigeration cannot. If the difference between the condensation and evaporation temperatures is large the compression ratio required to operate between the two temperatures may be too large for practical compressors. Using cascade refrigeration, the overall compression can be broken up into manageable compression ratios.



> **Apply now**

REDEFINE YOUR FUTURE  
**AXA GLOBAL GRADUATE  
PROGRAM 2015**

redefining / standards 

agence.cdg. © Photonistop

Note that refrigerant flow-rates will not necessarily be the same for each vapour compression cycle within a cascade. In order for the cascade refrigerator to function properly, there must be an enthalpy balance over the heat exchanger between the two cycles. Referring to the notation in Figure 2.10, the enthalpy balance is given by:

$$\dot{m}_H(h_5 - h_8) = \dot{m}_C(h_1 - h_4) \quad (2.24)$$

Were  $\dot{m}_H$  refers to the mass flow-rate of refrigerant in the top (higher temperature) cycle, and  $\dot{m}_C$  refers to the mass flow-rate in the bottom (lower temperature) cycle.

The cycles in a cascade refrigerator, need not employ the same refrigerant, which means that different refrigerants can be selected for the different cycles, depending on which refrigerant has the optimal thermodynamic properties (i.e. the refrigerant with optimal thermodynamic properties in the higher temperature range may not be the optimal refrigerant in the lower temperature range). However, if the same refrigerant is used in all cycles, a modification of cascade refrigeration known as *multi-stage refrigeration*, may work more efficiently.

### 2.6.2 Multi-stage refrigeration

Figure 2.11 shows an ideal multi-stage refrigeration cycle. The key difference between the multi-stage and cascade refrigeration cycles is the absence of the heat exchanger between separate vapour compression cycles. Instead, after the refrigerant is dropped from the condenser pressure to the intermediate pressure (path 7→8 in Figure 2.11), the gaseous fraction is separated from the liquid fraction using a *flash drum* (or *flash chamber*). The liquid fraction is then expanded again before it passes through the evaporator, and then the Compressor 1 (path 3→4→1→2 in Figure 2.11). The vapour coming from Compressor 1 (which is in the superheated state) is then mixed with the saturated vapour coming from the flash drum (path 8→9 in Figure 2.11), and the mixture is then compressed from the intermediate pressure to the higher pressure before it passes through the condenser, and the cycle is completed (path 5→6→7). Clearly this arrangement will only work if the same refrigerant is used throughout the cycle, and so it will not necessarily be more efficient than an optimised cascade refrigerator.



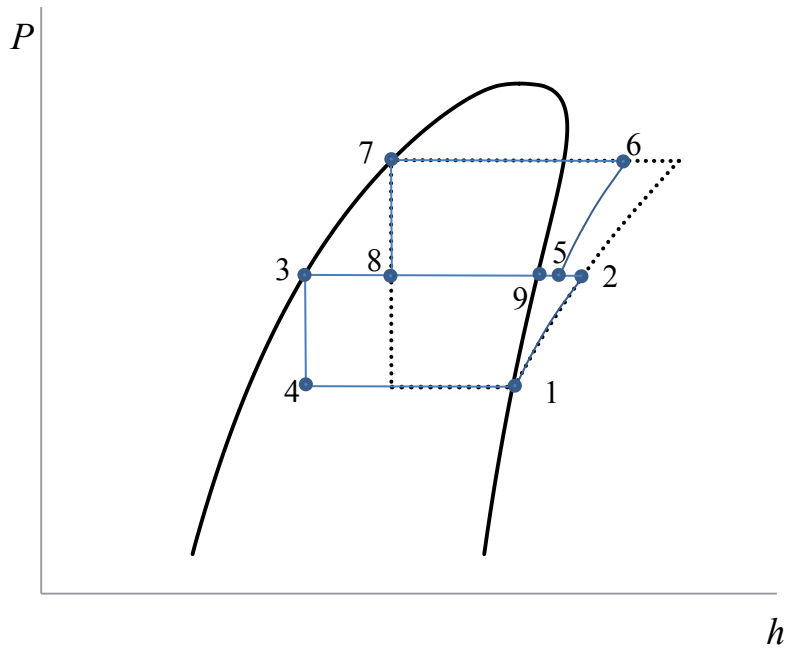

a)

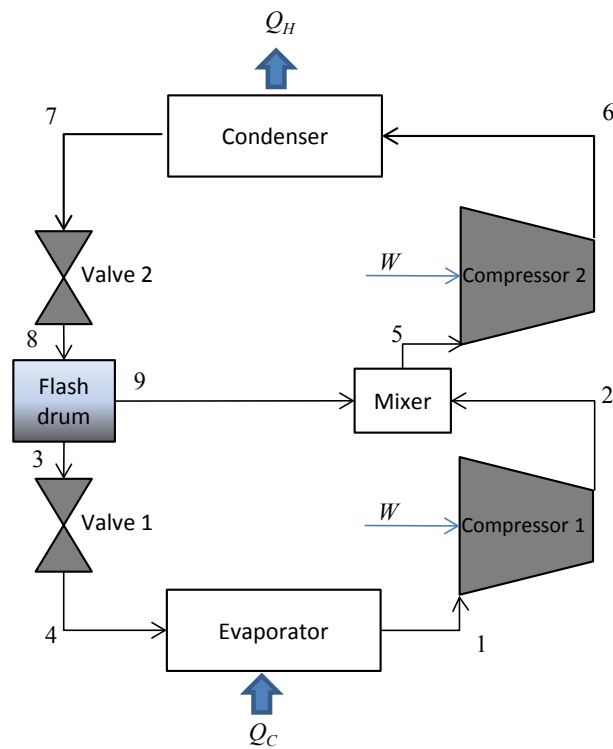

b)

**Figure 2.11:** Multi-stage refrigeration system

**Example 2.8:** Compare the  $COP_R$  values of a single-stage ideal vapour compression cycle with a two-stage, ideal cascade refrigerator both using R134a with a cooling load of 6 kW at an evaporator temperature of  $-26\text{ }^\circ\text{C}$ . The condenser pressure is 1.0 MPa, and for the sake of simplicity, you may assume that the evaporation and condensation processes in the heat exchanger both occur at a constant pressure of 0.3 MPa (although this would require infinite heat exchange area in reality). PH diagrams of the two systems are shown in Figure 2.12.

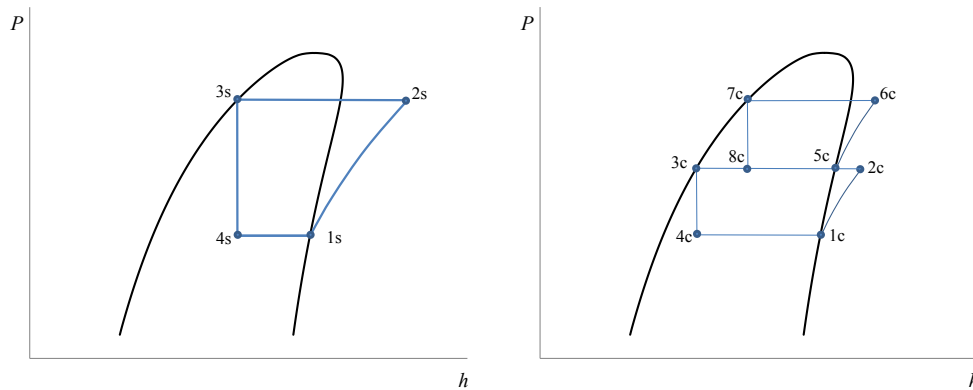

**Figure 2.12:** P-H diagrams for the single-stage and cascade refrigeration systems in Example 2.8



**BI**

- Business
- Strategic Marketing Management
- International Business
- Leadership & Organisational Psychology
- Shipping Management
- Financial Economics

**BI NORWEGIAN BUSINESS SCHOOL**

EFMD **EQUIS ACCREDITED**

## Empowering People. Improving Business.

BI Norwegian Business School is one of Europe's largest business schools welcoming more than 20,000 students. Our programmes provide a stimulating and multi-cultural learning environment with an international outlook ultimately providing students with professional skills to meet the increasing needs of businesses.

BI offers four different two-year, full-time Master of Science (MSc) programmes that are taught entirely in English and have been designed to provide professional skills to meet the increasing need of businesses. The MSc programmes provide a stimulating and multi-cultural learning environment to give you the best platform to launch into your career.

- MSc in Business
- MSc in Financial Economics
- MSc in Strategic Marketing Management
- MSc in Leadership and Organisational Psychology

[www.bi.edu/master](http://www.bi.edu/master)



**Solution:** The  $COP_R$  of the single-stage vapour compression process can be determined using the same steps as were used in Example 2.6. Using the information provided and Tables A1 and A2 (note that the subscript 's' refers to the single stage cycle, while the subscript 'c' refers to the cascade cycles):

$$P_{1s} = 0.1 \text{ MPa}, h_{1s} = 383 \text{ kJ kg}^{-1}, s_{1s} = 1.75 \text{ kJ kg}^{-1} \text{ K}^{-1} \quad (\text{Table A1})$$

$$P_{3s} = 1.0 \text{ MPa}, h_{3s} = 256 \text{ kJ kg}^{-1} = h_{4s} \quad (\text{Table A1})$$

$$P_{2s} = 1.0 \text{ MPa}, s_{2s} = s_{1s} = 1.75 \text{ kJ kg}^{-1} \text{ K}^{-1}, h_{2s} = 430 \text{ kJ kg}^{-1} \quad (\text{Table A2})$$

$$COP_{R,s} = \frac{h_1 - h_4}{h_2 - h_1} = \frac{383 - 256}{430 - 383} = 2.7$$

We can calculate the mass flow-rate of refrigerant required as follows:

$$\dot{m}_s = \frac{\dot{Q}_C}{Q_C} = \frac{\dot{Q}_C}{h_1 - h_4} = \frac{600 \text{ kW}}{(383 - 256) \text{ kJ kg}^{-1}} = 0.0472 \text{ kg s}^{-1}$$

For the cascade system:

$$P_{1c} = P_{1s} = 0.1 \text{ MPa}, h_{1c} = h_{1s} = 383 \text{ kJ kg}^{-1}, s_{1c} = s_{1s} = 1.75 \text{ kJ kg}^{-1} \text{ K}^{-1} \quad (\text{Table A1})$$

$$P_{3c} = 0.3 \text{ MPa}, h_{3c} = 200 \text{ kJ kg}^{-1} = h_{4c} \quad (\text{Table A1})$$

$$P_{2c} = 0.3 \text{ MPa}, s_{2c} = s_{1c} = 1.75 \text{ kJ kg}^{-1} \text{ K}^{-1}, h_{2c} = 405 \text{ kJ kg}^{-1} \quad (\text{Table A2})$$

$$P_{5c} = 0.3 \text{ MPa}, h_{5c} = 399 \text{ kJ kg}^{-1}, s_{5c} = 1.73 \text{ kJ kg}^{-1} \text{ K}^{-1} \quad (\text{Table A1})$$

$$P_{7c} = 1.0 \text{ MPa}, h_{7c} = 256 \text{ kJ kg}^{-1} = h_{8c} \quad (\text{Table A1})$$

$$P_{6c} = 1.0 \text{ MPa}, s_{6c} = s_{5c} = 1.73 \text{ kJ kg}^{-1} \text{ K}^{-1}, h_{6c} = 425 \text{ kJ kg}^{-1} \quad (\text{Table A2})$$

To calculate the  $COP_R$  of the cascade refrigerator, we will need to calculate flow-rates of refrigerant in the two loops as follows:

$$\dot{m}_C = \frac{\dot{Q}_C}{Q_C} = \frac{\dot{Q}_C}{h_{1c} - h_{4c}} = \frac{6}{383 - 200} = 0.0328 \text{ kg s}^{-1}$$

$$\dot{m}_H = \dot{m}_C \frac{(h_{2c} - h_{3c})}{(h_{5c} - h_{8c})} = 0.0328 \times \frac{405 - 200}{399 - 256} = 0.0470 \text{ kg s}^{-1}$$

The combined work input to the compressors in the cascade system is given by:

$$\begin{aligned}\dot{W}_c &= \dot{W}_C + \dot{W}_H = \dot{m}_C(h_{2c} - h_{1c}) + \dot{m}_H(h_{6c} - h_{5c}) \\ &= 0.0328 \times (405 - 383) + 0.0470 \times (425 - 399) \\ &= 1.94 \text{ kW}\end{aligned}$$

Hence:

$$COP_{R,c} = \frac{Q_C}{W_c} = \frac{6}{1.94} = 3.1$$

**Note:** The cascade refrigeration system requires less work for the same cooling load, but has a greater charge of refrigerant and requires more plant (i.e. extra compressor, heat exchanger and valve plus auxiliaries).

## 2.7 Sorption refrigeration

So far we have considered vapour compression cycles which make up the vast majority of commercial refrigeration, heat pump and air conditioning units. However there is a wide range of practical alternatives to vapour compression as a means of transferring heat from a low temperature to a high temperature. Many of these, such as the thermo-electric devices, magnetic refrigeration and acoustic refrigeration are currently limited to small-scale and niche applications, and these will be covered briefly in Chapter 5. Probably the only rival to vapour-compression on the medium to large scale is *sorption refrigeration*, a collective term for *absorption* and *adsorption* refrigeration. Sorption refrigeration cycles are similar in principle to vapour compression cycles, with the main difference being that vapour compression is replaced in a novel way such that the work input required to drive the cycle is very small, and instead the cycle is essentially driven by heat.

Consider the schematic of the absorption refrigeration cycle shown in Figure 2.13. Comparison of Figure 2.13 with Figure 2.7c illustrates that the condenser, expansion valve and evaporator are the same for both cycles. The difference occurs once the refrigerant vapour leaves the evaporator, where, in the case of absorption refrigeration, instead of entering a compressor it is dissolved in a liquid absorbent. The refrigerant/absorbent mixture is then pumped to the condenser pressure where the refrigerant vapour is liberated in the generator by heat from an external source such as industrial waste heat or solar energy.

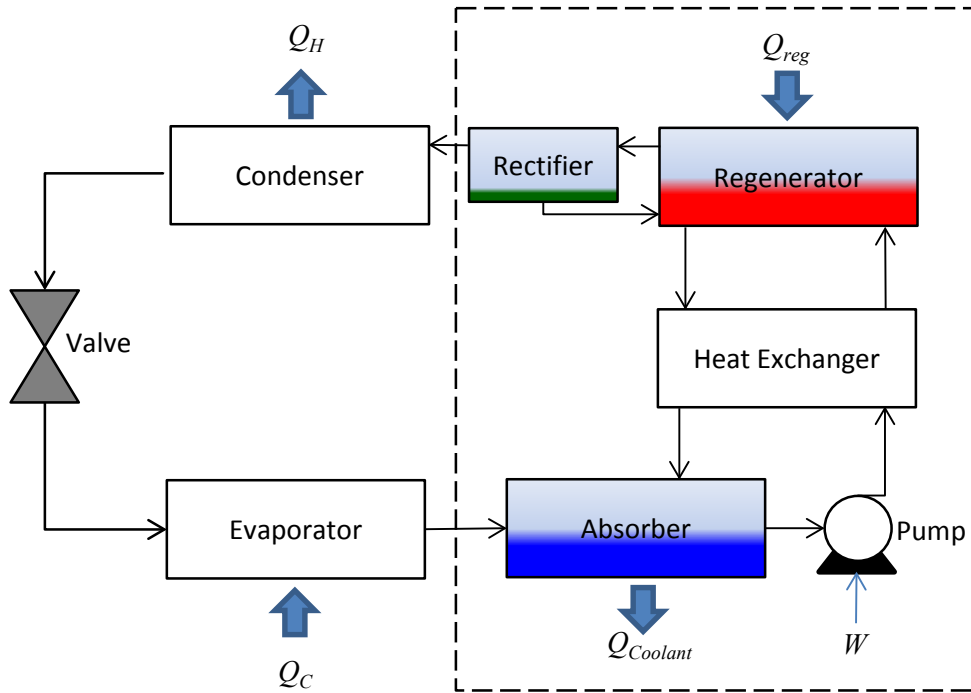

Figure 2.13: Schematic of an absorption refrigerator

# Need help with your dissertation?

Get in-depth feedback & advice from experts in your topic area. Find out what you can do to improve the quality of your dissertation!

**Get Help Now**



Go to [www.helpmyassignment.co.uk](http://www.helpmyassignment.co.uk) for more info



 **Click on the ad to read more**

The vapour stream from the regenerator is comprised mainly of refrigerant; however, it will most likely contain some entrained absorbent as well. The remaining absorbent is separated from the refrigerant in the rectifier, and then returned to the regenerator, while the refrigerant vapour enters the condenser and the cycle is repeated.

The liquid phase in the regenerator which is mainly made up of absorbent, but will most likely contain a small amount of un-liberated refrigerant is returned to the absorber. Since the liquid stream entering the absorber needs to be heated, and the liquid stream leaving the regenerator needs to be cooled, they are passed through a heat exchanger, which reduces the external heating and cooling duties. Generally speaking, the lower the temperature of the absorbent, the more refrigerant it will be able to dissolve, so there is an incentive to actively cool it, at least with cooling water (i.e. water at ambient temperature).

Clearly the interaction between the refrigerant and absorbent plays a key role in their selection. The refrigerant needs to be highly soluble in the absorbent at low temperature and pressure and only sparingly soluble at higher temperature and pressure. A common pairing is ammonia as the refrigerant and water as the absorbent. Ammonia, which is an excellent refrigerant in a vapour compression cycle, is highly soluble in water at low temperatures, but also has a much higher vapour pressure than water, so is easily liberated at higher temperature. The disadvantage of ammonia is that it is highly flammable and toxic, which means that it is best suited to industrial applications where proper maintenance and safety precautions are likely to be practiced. Another common pairing is water as the refrigerant and an aqueous solution of lithium bromide as the absorbent, although this system is limited by the relatively high freezing temperature of water, and the hazardous nature of lithium bromide.

A COP is essentially the ratio of the cooling output to the energy input. For a sorption refrigerator this means:

$$COP_{R,Abs} = \frac{Q_c}{Q_{reg} + W + Q_{cool}} \approx \frac{Q_c}{Q_{reg}}$$

Sorption refrigerators are more complex and require greater maintenance than vapour-compression refrigerators, and are significantly less efficient. Their advantage, however, is that under the right circumstances they are cheaper to run. Liquid pumping is far less energy intensive than vapour compression, and in terms of the absorption refrigerator, the work input is almost negligible. If the heat input comes from a solar thermal array or industrial waste heat then it is essentially 'cost-free' energy, in which case the lower efficiency of the system can easily be justified economically.

Since the work required to run the cycle is small, and the heat source is likely to be renewable (solar) or 'recycled' (waste heat), another factor in the absorption refrigerator's favour is that it can be argued that it has less impact on the environment, especially in countries where electricity is generated by non-renewable methods.

## 2.8 Summary of Chapter 2

The majority of refrigerators, air conditioners and heat pumps operate using the vapour compression cycle. The performance of these devices is measured by the ratio of the amount of cooling (in the case of refrigerators and air conditioners) or heating (in the case of heat pumps) delivered divided by the work required to run the cycle, which is mainly associated with the compression stage. This ratio is known as the *coefficient of performance*, or COP:

$$COP_R = \frac{Q_C}{W} \quad COP_{HP} = \frac{Q_H}{W}$$

The most efficient refrigerator or heat pump possible operates using the reversed Carnot cycle, and it was shown that the COPs for a reversed Carnot cycle are:

$$COP_{R,Carnot} = \frac{T_C}{T_H - T_C} \quad COP_{HP,Carnot} = \frac{T_H}{T_H - T_C}$$

The COPs of the reversed Carnot cycle illustrate principles that are generally true of real devices:

- The performance of refrigerators and heat pumps is increased by an increase in the target temperature ( $T_H$  or  $T_C$ ), and decreased by an increase in the difference between  $T_H$  and  $T_C$
- Any device that may be operated both as a heat pump and a refrigerator (e.g. the typical domestic heat pump) will have a higher COP when operated as a heat pump than as a refrigerator

For set values of  $T_H$  and  $T_C$ , the COPs for devices employing the vapour compression cycles may be increased by breaking the overall compression process into stages, by employing cascade or multi-stage refrigeration.

Sorption refrigeration offers the main alternative to vapour compression refrigeration, and can be thought of as being driven by heat rather than by work. Sorption refrigerators are generally less efficient than vapour compression refrigerators, but they can be cheaper to run and have the potential to have less impact on the environment.

## 2.9 Further Reading

*ASHRAE Handbook: Refrigeration*, American Society of Heating, Refrigeration and Air Conditioning Engineers, Atlanta, GA, 2010

Çengel, YA & Boles, MA, *Thermodynamics: An Engineering Approach*, 7<sup>th</sup> Ed., McGraw Hill, New York, 2011

Smith, JM, van Ness, HC & Abbott, MM., *Introduction to Chemical Engineering Thermodynamics*, 7<sup>th</sup> Ed., McGraw Hill, New York, 2005

Whitman, WC, Johnson, WM, Tomczyk, JA & Silberstein, E, *Refrigeration and Air Conditioning Technology*, 6<sup>th</sup> Ed., Delmar, New York, 2009



**Brain power**

By 2020, wind could provide one-tenth of our planet's electricity needs. Already today, SKF's innovative know-how is crucial to running a large proportion of the world's wind turbines.

Up to 25 % of the generating costs relate to maintenance. These can be reduced dramatically thanks to our systems for on-line condition monitoring and automatic lubrication. We help make it more economical to create cleaner, cheaper energy out of thin air.

By sharing our experience, expertise, and creativity, industries can boost performance beyond expectations. Therefore we need the best employees who can meet this challenge!

The Power of Knowledge Engineering

Plug into The Power of Knowledge Engineering.  
Visit us at [www.skf.com/knowledge](http://www.skf.com/knowledge)

**SKF**



# 3 Heat Transfer

Classical thermodynamics considers changes between thermodynamic states (i.e. changes in variables such as temperature, pressure, enthalpy etc.) but not the rate at which changes occur. However, rates of change are often important for practical purposes. High efficiency designs or processes, as identified by the Laws of Thermodynamics, may be too slow to be practical, and some compromise between energy efficiency and practicality will often be required. For this reason we need a separate, but related discipline known as 'heat transfer' (also known as 'heat transport' or 'heat transmission'), which is the science concerned with calculating heat flows and temperatures as a function of time and location.

## 3.1 Modes of heat transfer

Heat may be transferred by three different mechanisms:

- **Conduction** is the transfer of thermal energy from high-temperature regions of a substance to adjacent, lower-temperature regions as a result of physical interaction between atoms/molecules in the form of collisions and vibrations.
- **Convection** is the combined effect of conduction and fluid motion, from density differences (buoyancy), wind or natural water flows, or mechanical means
- **Thermal Radiation** is energy emitted by matter in the form of electromagnetic waves (or photons) over a range of wavelengths. It does not occur as the result of direct physical contact between atoms or molecules.

As a generalisation, we are concerned with conduction within solids, and convection within fluids and radiation between surfaces separated by a fluid. Radiation is the most difficult of the three modes to model mathematically and in refrigeration applications its influence is relatively minor (although certainly not negligible) and hence its effects may often be approximated simply or combined with the effects of convection, as will be assumed to be the case throughout the remainder of this chapter.

## 3.2 Steady state conduction and convection

Many of the heat transfer analyses involved in refrigeration can be performed with *steady state* models, i.e. models which assume there is no net change with time in the variables of interest (or at least no *significant* net change).

One dimensional steady state conduction is described by Fourier's Law:

$$\dot{Q}_x = -kA \frac{dT}{dx} \quad (3.1)$$

where:  $k$  is thermal conductivity ( $\text{W m}^{-1} \text{K}^{-1}$ ),  $A$  is the cross-sectional area in the direction of the heat flow ( $\text{m}^2$ ) and  $dT/dx$  is the temperature gradient in the  $x$ -direction ( $\text{K m}^{-1}$ ) and the subscript  $x$  is to indicate the heat flow in the  $x$ -direction. Note that the negative sign in Fourier's Law is to ensure that the heat flow is positive when heat flows from a higher temperature to a lower temperature (i.e. when the temperature gradient is negative), so that the Second Law of Thermodynamics is not violated. When rearranged to be explicit in terms of  $k$ , Eq. (3.1) actually serves as a definition of thermal conductivity. Data for thermal conductivity of different materials may be found in a wide variety of sources, including those listed at the end of this chapter.

For a plane wall Eq. (3.1) may be rewritten:

$$\dot{Q} = kA \frac{(T_2 - T_1)}{\Delta x} \quad (3.2)$$

where the subscripts 1 and 2 refer to either side of the plane wall and  $\Delta x$  is the thickness of the wall. In cylindrical polar coordinates Fourier's Law may be written:

$$\dot{Q}_r = -kA_r \frac{dT}{dr} \quad (3.3)$$

where  $r$  is the radial distance from the centreline (origin) and the subscript  $r$  indicates that heat flow is in the radial direction. Note that the cross sectional area in the radial direction depends on the radius:

$$A_r = 2\pi rL \quad (3.4)$$

where  $L$  is the length in the axial direction (m). To obtain an expression for heat flow through a pipe wall we must integrate Eq. (3.3) between suitable limits after substituting in Eq. (3.4):

$$\begin{aligned} \dot{Q}_r &= -2\pi kL \frac{dT}{dr} \\ \int_{r_i}^{r_o} \frac{dr}{r} &= \frac{-2\pi kL}{\dot{Q}_r} \int_{T_i}^{T_o} dt \\ \dot{Q}_r &= 2\pi kL \frac{(T_i - T_o)}{\ln(r_o / r_i)} \end{aligned} \quad (3.5)$$

where the subscripts  $o$  and  $i$  refer to the condition at the outside and inside respectively of the pipe wall.

Steady state convection is described very simply by Newton's Law of Cooling:

$$\dot{Q} = hA(T_2 - T_1) \quad (3.5)$$

where  $h$  is referred to as the heat transfer coefficient ( $W\ m^{-2}\ K^{-1}$ ), or the film heat transfer coefficient. As with thermal conductivity and Fourier’s Law, Newton’s Law of Cooling actually serves as the definition of  $h$ , i.e. the proportionality between a temperature difference and a heat flux. Experiments have shown that  $h$  is dependent on a large number of factors including the velocity and turbulence of the fluid over the surface of an object and the physical properties of the fluid. In practice heat transfer coefficients are often determined from correlations of experimental data. A large number of data for flow in pipes and ducts and over flat plates may be found in the literature (including the references listed at the end of this chapter). Table 3.1 gives a list of indicative values for heat transfer coefficients.

	$h$ ( $W\ m^{-2}\ K^{-1}$ )
Natural Convection of gases	1–50
Forced of Convection of gases	25–500
Natural Convection of liquids	10–1000
Forced Convection of liquids	50–10,000
Boiling and Condensation	2000–100,000

**Table 3.1:** Typical values of convection heat transfer coefficients

**What do you want to do?**

No matter what you want out of your future career, an employer with a broad range of operations in a load of countries will always be the ticket. Working within the Volvo Group means more than 100,000 friends and colleagues in more than 185 countries all over the world. We offer graduates great career opportunities – check out the Career section at our web site [www.volvogroup.com](http://www.volvogroup.com). We look forward to getting to know you!

**VOLVO**  
 AB Volvo (publ)  
[www.volvogroup.com](http://www.volvogroup.com)

VOLVO TRUCKS | RENAULT TRUCKS | MACK TRUCKS | VOLVO BUSES | VOLVO CONSTRUCTION EQUIPMENT | VOLVO PENTA | VOLVO AERO | VOLVO IT  
 VOLVO FINANCIAL SERVICES | VOLVO 3P | VOLVO POWERTRAIN | VOLVO PARTS | VOLVO TECHNOLOGY | VOLVO LOGISTICS | BUSINESS AREA ASIA

Click on the ad to read more

It is worth noting from Table 3.1 that heat transfer coefficients due to flowing liquids (i.e. forced convection) are typically orders of magnitudes higher than flowing gases, and that heat transfer coefficients due to condensation and boiling processes are typically orders of magnitudes higher than for flowing liquids. Hence the phase change processes that take place in the condenser and evaporator are beneficial not only because of the high energy storage capacity, but also because of the high rates of heat transfer that may occur.

Consider the diagram shown in Figure 3.1, of a plane wall separating two fluids in which the bulk fluid temperature on one side of the wall is kept constant at  $T_{\infty,i}$ , while the bulk fluid on the other side of the window is kept constant at some lower temperature  $T_{\infty,o}$  (e.g. a window in a room which has the air temperature thermostatically controlled during a period when the outside air temperature remains essentially constant).

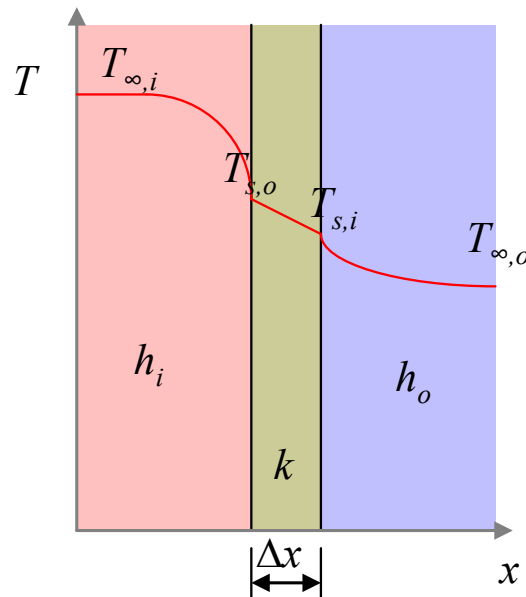

**Figure 3.1:** Schematic of a plane wall separating two fluids

Note that while the temperature of the fluid (say, air) a certain distance away from the window will have little dependence on  $x$ , there is a noticeable reduction in temperature as it approaches the surface of the wall, due to the presence of a boundary layer of air – a layer of air that is prevented from mixing as thoroughly with the air in the room due to friction against the surface of the window pane. Likewise there is a boundary layer on the outside of the window. A typical temperature profile of this situation is indicated by the red line in Figure 3.1.

According to Newton's Law of Cooling, the heat transferred from the air inside the room to the surface of the window is:

$$\dot{Q} = h_i A (T_{\infty,i} - T_{s,i}) \quad (3.6)$$

where the subscript  $s$  refers to the surface of the window. A similar expression may be obtained for the flow of heat between the outside surface of the window and the bulk air outside:

$$\dot{Q} = h_o A (T_{s,o} - T_{\infty,o}) \quad (3.6)$$

The heat flow through the window pane is given by Fourier's Law:

$$\dot{Q} = kA \frac{(T_{s,i} - T_{s,o})}{\Delta x} \quad (3.7)$$

Since the system is at steady state (i.e. temperatures and heat flows do not vary with time) the heat flow from the inside bulk air to the inside window surface must be equal to the heat flow through the window pane and also to the heat flow from the outside surface to the bulk air outside, i.e.:

$$\dot{Q} = h_i A (T_{\infty,i} - T_{s,i}) = kA \frac{(T_{s,i} - T_{s,o})}{\Delta x} = h_o A (T_{s,o} - T_{\infty,o}) \quad (3.8)$$

From the equalities in Eq. (3.8) we can eliminate  $T_{s,i}$  and  $T_{s,o}$  to give an expression for heat flow in terms of the bulk air temperatures inside and out:

$$\dot{Q} = \frac{A(T_{\infty,i} - T_{\infty,o})}{\frac{1}{h_i} + \frac{1}{k} + \frac{1}{h_o}} \quad (3.9)$$

We can combine the resistances to flow from the inside surface boundary layer, the pane of glass and the outside surface boundary layer in one variable called the Overall Heat Transfer Coefficient ( $U$ ):

$$U = \frac{1}{\frac{1}{h_i} + \frac{1}{k} + \frac{1}{h_o}} \quad (3.10)$$

and Eq. 3.9 may be simplified to

$$\dot{Q} = UA(T_{\infty,i} - T_{\infty,o}) \quad (3.11)$$

The overall heat transfer coefficient is a convenient parameter for characterising steady-state heat transfer, and is very useful for performing calculations and analyses in heat exchangers, such as a condenser or evaporator of a refrigeration system, and also for modelling heat infiltration into a refrigerator, from a variety of sources. Its value may be determined relatively simply by relatively straightforward experiments, as will be illustrated for a heat exchanger later in Example 3.1.

### 3.3 Heat Exchangers

The scenario depicted in Figure 3.1 assumes that the heat flow from one fluid to the other is small enough so as to have negligible impact on either bulk fluid temperature  $T_{\infty,i}$  or  $T_{\infty,o}$  (i.e. the two fluids behave as thermal reservoirs). This assumption allows us to assume the bulk fluid temperatures remain constant over prescribed time periods. This scenario is reasonable when considering heat loss through a window, for example, but is not accurate for heat exchangers, where the purpose of the heat exchanger is to change the fluid temperatures.

For heat exchangers we are typically interested in four temperatures, the inlet and outlet temperatures of the stream on the higher temperature side ( $T_{H,i}$  and  $T_{H,o}$ ) and the inlet and outlet temperatures on the lower temperature side ( $T_{C,i}$  and  $T_{C,o}$ ). Because the temperature of the hotter fluid is not constant, but varies between  $T_{H,i}$  and  $T_{H,o}$  (and similarly for the colder fluid) we cannot use a simple expression like Eq. (3.11), even if we know the heat transfer area and the overall heat transfer coefficient. What we need is an expression for the average temperature difference between the two fluids over the entire heat exchange surface, and the appropriate average in this case is the *logarithmic mean*, or more specifically in this context, the Logarithmic Mean Temperature Difference (LMTD or  $\Delta T_{LM}$ ) defined by Eq. (3.12) for *counter-current* flow (see Figure 3.2):

$$\Delta T_{LM} = \frac{(T_{H,i} - T_{C,o}) - (T_{H,o} - T_{C,i})}{\ln\left(\frac{T_{H,i} - T_{C,o}}{T_{H,o} - T_{C,i}}\right)} \quad (3.12)$$

**gaieteye**  
Challenge the way we run

**EXPERIENCE THE POWER OF FULL ENGAGEMENT...**

**RUN FASTER.  
RUN LONGER..  
RUN EASIER...**

**READ MORE & PRE-ORDER TODAY  
WWW.GAITEYE.COM**

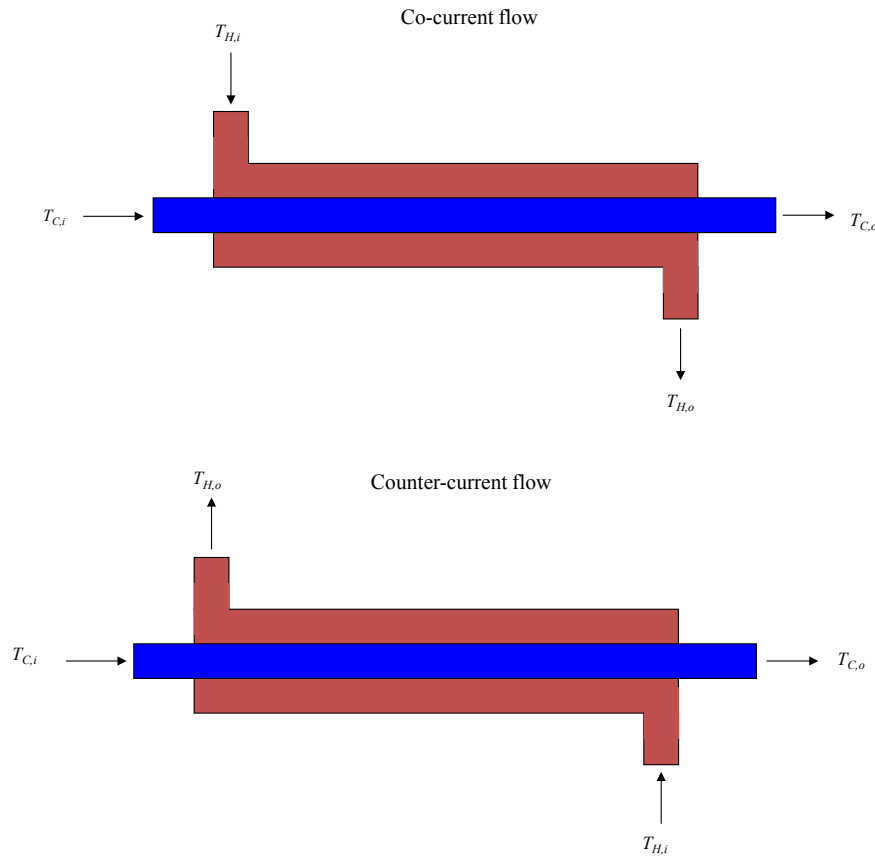

**Figure 3.2:** Illustration of co-current and counter-current flow in a heat exchanger

Counter-current flow, in which the fluids enter the exchanger at opposite ends is more efficient than co-current flow, in which the fluids enter the exchanger at the same end simply because the LMTD will be higher for given values of  $T_{H,i}$ ,  $T_{H,o}$ ,  $T_{C,i}$  and  $T_{C,o}$  [*Demonstrate this for yourself! To get the co-current form of the LMTD, simply switch the positions of  $T_{C,i}$  and  $T_{C,o}$  in Eq. (3.12)*].

By substituting the definition of the LMTD into Eq. (3.11) we get a more useful equation for heat exchangers:

$$\dot{Q} = UA\Delta T_{LM} \quad (3.13)$$

Equation 3.13 is sometimes referred to as the Heat Exchanger Equation.

In some cases the outlet temperatures of the two streams in a heat exchanger may not be known, and hence the LMTD cannot be determined. However, using a technique known as the *Effectiveness-NTU Method*, the heat transferred and outlet temperatures of both streams may be determined, provided the overall heat transfer coefficient, heat transfer area and heat capacities of both streams are known. The reader is directed to the references listed at the end of this chapter for more information of the Effectiveness-NTU method.

**Example 3.1.** A counter-current heat exchanger is used to cool a process stream from 80 °C to 35 °C, using water from a river at 15 °C. If the mass flow-rate of the process stream is 40 kg s<sup>-1</sup>, its specific heat capacity is 3.9 kJ kg<sup>-1</sup> K<sup>-1</sup> and the heat transfer area of the heat exchanger is 200 m<sup>2</sup>, calculate:

- a) the required flow-rate of cooling water if the exit temperature is not allowed to rise above 25 °C (assume the specific heat capacity of water is 4.18 kJ kg<sup>-1</sup> K<sup>-1</sup>)
- b) the overall heat transfer coefficient of heat exchanger.

**Solution: a)** The mass flow-rate of the cooling water may be found by performing an enthalpy balance on both fluid streams. From the process stream we can calculate the heat transferred from its change in enthalpy:

$$\begin{aligned}\dot{Q} &= \Delta H_H = \dot{m}_H C_{p,H} (T_{H,i} - T_{H,o}) \\ &= 40 \times 3.9 \times (80 - 35) \\ &= 7020 \text{ kW}\end{aligned}$$

The mass flow-rate of the cooling fluid may then be determined from the enthalpy balance on the cooling water

$$\begin{aligned}\dot{Q} &= \Delta H_C = \dot{m}_C C_{p,C} (T_{C,i} - T_{C,o}) \\ \dot{m}_C &= \frac{\dot{Q}}{C_{p,C} (T_{C,i} - T_{C,o})} \\ &= \frac{7020}{3.9 \times (25 - 15)} \\ &= 168 \text{ kg s}^{-1}\end{aligned}$$

- b) The overall heat transfer coefficient may be determined from Eq. 3.13 after first calculating the logarithmic mean temperature difference.



$$\begin{aligned}\Delta T_{LM} &= \frac{(T_{H,i} - T_{C,o}) - (T_{H,o} - T_{C,i})}{\ln\left(\frac{T_{H,i} - T_{C,o}}{T_{H,o} - T_{C,i}}\right)} \\ &= \frac{(80 - 25) - (35 - 15)}{\ln\left(\frac{80 - 25}{35 - 25}\right)} \\ &= 34.6^\circ\text{C}\end{aligned}$$

Hence:

$$\begin{aligned}\dot{Q} &= UA\Delta T_{LM} \\ U &= \frac{\dot{Q}}{A\Delta T_{LM}} \\ &= \frac{7020}{200 \times 34.6} \\ &= 1.01 \text{ kW m}^{-2} \text{ K}^{-1}\end{aligned}$$

This e-book  
is made with  
**SetaPDF**

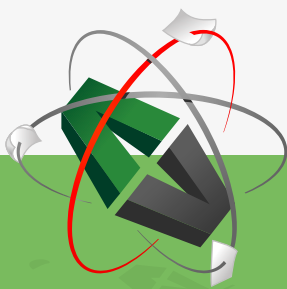

PDF components for PHP developers

[www.setasign.com](http://www.setasign.com)



In Example 3.1 the fluids on both sides of the heat exchange surface had temperatures varying continuously along the length of the heat exchanger; however, in the evaporator and condenser of a refrigeration system, the refrigerant temperature will not vary as significantly because of the phase change occurring. In fact, for first-approximation calculations it will be reasonable to assume that the refrigerant temperature is constant at the condensing temperature (as determined from the phase diagram or refrigerant property tables) or evaporating temperature, as appropriate.

Another point to note is that the need for a finite temperature difference across the heat exchange surface in a heat exchanger reduces the performance of a refrigeration system. This point is illustrated in Figure 3.3, and Example 3.2.

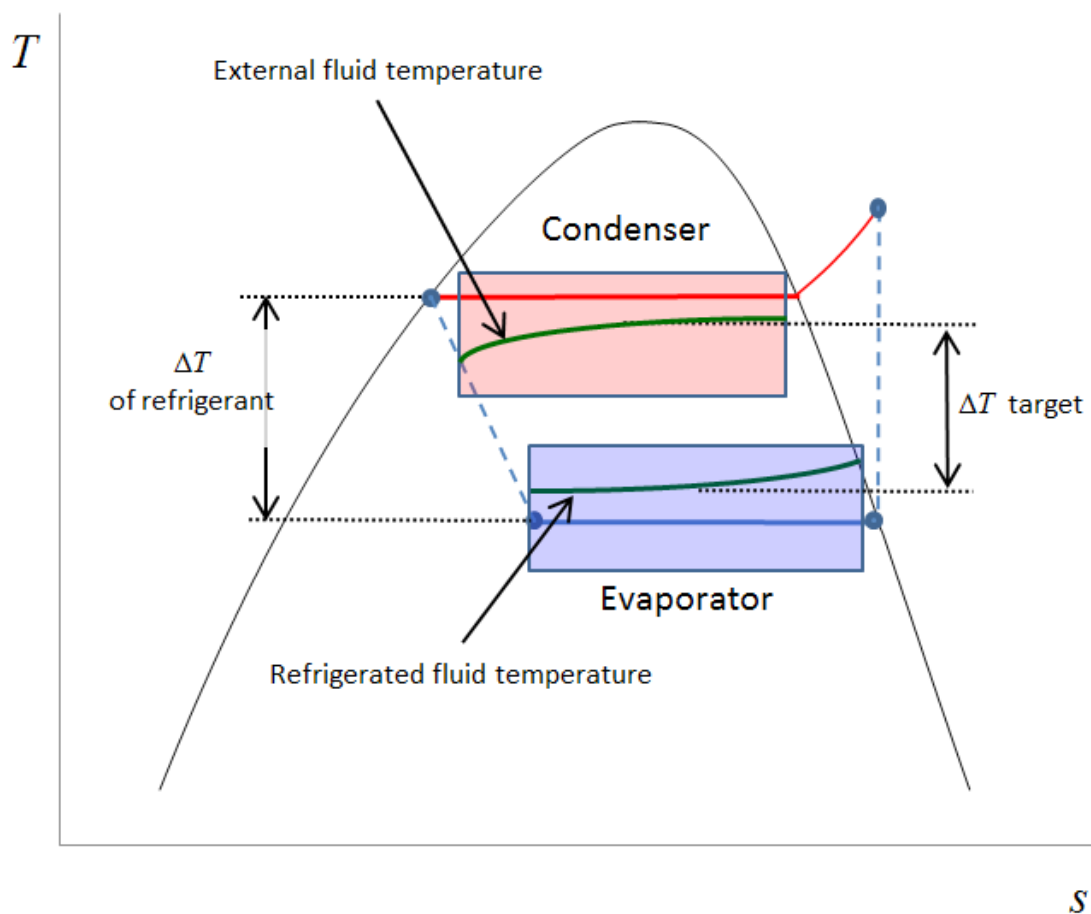

**Figure 3.3:** Schematic of the relative temperature differences between the evaporator and condenser, superimposed on a T-S diagram for a vapour compression cycle (c.f. Fig. 2.7a).

**Example 3.2:** If a refrigerator is being used to maintain a temperature of 4 °C, and is rejecting heat to air at 25 °C, calculate the difference in Carnot COP based on the refrigerant temperatures and the air-side temperatures, if the LMTD of each heat exchanger is a) 5 °C, b) 10 °C.

**Solution:** a) From Eq. 2.18, the COP based on the external and refrigerated air temperatures is:

$$COP_{R,Carnotair} = \frac{T_C}{T_H - T_C} = \frac{4 + 273.15}{25 - 4} = 13.2$$

The COP based on the refrigerant temperatures with an LMTD of 5 °C is:

$$COP_{R,Carnotrefrigerant} = \frac{T_C}{T_H - T_C} = \frac{(4 - 5) + 273.15}{(25 + 5) - (4 - 5)} = 8.8$$

b) With an LMTD of 10 °C the COP is:

$$COP_{R,Carnotrefrigerant} = \frac{T_C}{T_H - T_C} = \frac{(4 - 10) + 273.15}{(25 + 10) - (4 - 10)} = 6.5$$

Example 3.2 shows that the maximum performance of the refrigerator is decreased as the LMTD is increased. So why do we not choose to have minimal LMTD in condensers and evaporators, thereby maximising the COP? The answer can be seen by rearranging the heat exchanger equation (i.e. Eq. 3.13):

$$A = \frac{\dot{Q}}{U\Delta T_{LM}} \quad (3.14)$$

For a given heat duty and overall heat transfer coefficient, the required heat transfer area (and hence size and cost of the heat exchanger) is inversely proportional to the LMTD. The temperature difference across the heat exchanger is therefore a key design variable whose value will be determined by a trade-off between the greater energy efficiency of a small LMTD against the lower costs and size of a larger LMTD.

### 3.4 Transient Heat Transfer

When an object (e.g. a food product) is placed into a refrigerator, we are often interested in the time required for the object to cool to a specified temperature, and perhaps also the instantaneous rate of heat loss from the product. This is vitally important with temperature-sensitive materials, including most biological products, where there is a risk of spoilage if the rate of temperature change is either too slow or too fast. Since the temperature change and heat transfer rates are dependent on time, we cannot use the simple steady-state equations of Sections 3.2 and 3.3.

For liquids we can assume that, due to natural convection, the temperature within the liquid container is roughly uniform and therefore may be represented by one temperature. In this situation an enthalpy balance around the food product which is cooled at its surface by some medium (usually, but certainly not exclusively, air) is given by:

$$\rho V C_p \frac{dT}{dt} = hA(T - T_\infty) \quad (3.15)$$

Rearrangement and integration of Eq. (1) with  $T = T_0$  when  $t = 0$  and  $T = T(t)$  when  $t = t$  gives:

$$T(t) = T_\infty + (T_0 - T_c) \exp\left(-\frac{hA}{\rho V C_p} t\right) \quad (3.16)$$

Eq. (3.16) is often referred to as the 'lumped heat capacity model' and gives a simple exponential decay relationship between temperature and time. As well as being a realistic model for liquids, it can occasionally be used for solids, provided the size of the object is small (a thickness of a few millimetres) and it is being cooled in still air. The heat load for this problem can be determined from:

$$\dot{Q} = hA[T(t) - T_\infty] = hA(T_i - T_\infty) \exp\left(-\frac{hA}{\rho V C_p} t\right) \quad (3.17)$$

For solids (or for highly viscous liquids) the spatial temperature variation within the object must be accounted for and a simple enthalpy balance such as Eq. (3.15) will not be adequate. For a material having uniform composition and whose thermal properties are independent of temperature, conduction within the product is governed by Fourier's Second Law, which is a form of commonly occurring partial differential equation called the *Diffusion Equation*:

$$\rho C_p \frac{\partial T}{\partial t} = k \nabla^2 T \quad (3.18)$$



www.sylvania.com

We do not reinvent the wheel we reinvent light.

Fascinating lighting offers an infinite spectrum of possibilities: Innovative technologies and new markets provide both opportunities and challenges. An environment in which your expertise is in high demand. Enjoy the supportive working atmosphere within our global group and benefit from international career paths. Implement sustainable ideas in close cooperation with other specialists and contribute to influencing our future. Come and join us in reinventing light every day.

Light is OSRAM

OSRAM SYLVANIA

Assuming convection at the surface and symmetrical heat transfer, we have the following boundary conditions:

$$k \frac{\partial T}{\partial r} \Big|_{r=0} = 0 \quad \text{and} \quad k \frac{\partial T}{\partial r} \Big|_{r=R} = h(T - T_\infty) \quad (3.19)$$

Note that an 'apparent heat transfer coefficient' may be used which will include the effects of radiation (and in some cases evaporation or packaging) in addition to convection.

For regular geometries in which heat transfer is only significant in one dimension (e.g. the sphere, the long cylinder and the plane wall) and objects being initially at some uniform temperature ( $T_0$ ), the solution of Eq. (3.18) with convection boundary conditions may be written generally as:

$$\theta(r, t) \equiv \frac{T(r, t) - T_\infty}{T_0 - T_\infty} = \sum_{n=1}^{\infty} \psi_n(\lambda_n) \exp(-\lambda_n^2 Fo) \zeta_n(\lambda_n, r) \quad (3.20)$$

where:

$$Fo = \frac{kt}{\rho C_p R^2} \quad (3.21)$$

and the  $\lambda_n$  parameters are functions of the the object's geometry and the Biot number:

$$Bi = \frac{hR}{k} \quad (3.22)$$

For a sphere of radius  $R$ :

$$1 - \lambda_n \cot \lambda_n = Bi \quad (3.23)$$

$$\psi_n(\lambda_n) = \frac{4(\sin \lambda_n - \lambda_n \cos \lambda_n)}{2\lambda_n - \sin(2\lambda_n)} \quad (3.24)$$

$$\zeta_n(\lambda_n, r) = \frac{\sin(\lambda_n r / R)}{\lambda_n r / R} \quad (3.25)$$

The Biot number is a very important parameter in any transient heat transfer problem involving conduction because it is the ratio of internal to external heat transfer resistance. A high  $Bi$  (e.g.  $Bi > 10$ ) indicates that the heat transfer process is dominated by conduction within the product, while a low  $Bi$  (e.g.  $Bi < 0.1$ ) indicates that resistance to heat transfer is dominated by resistance between the product's surface and the cooling fluid (and Eq. 3.16 may therefore be applied). Most cooling models are dependent on  $Bi$ .

After a certain time has elapsed such that  $Fo > 0.2$ , only the first term in the infinite series in Eq. (3.20) is significant, hence for a sphere:

$$\theta_{sph}(r,t) = \frac{T(r,t) - T_\infty}{T_i - T_\infty} = \frac{4(\sin \lambda_1 - \lambda_1 \cos \lambda_1)}{2\lambda_1 - \sin(2\lambda_1)} \exp(-\lambda_1^2 Fo) \frac{\sin(\lambda_1 r / R)}{\lambda_1 r / R} \quad (3.26)$$

Often (particularly with refrigeration) we are interested in the centre temperature (i.e. when  $r = 0$ ). In this case Eq. (3.26) reduces to:

$$\theta_{sph}(0,t) = \frac{T(0,t) - T_\infty}{T_i - T_\infty} = \frac{4(\sin \lambda_1 - \lambda_1 \cos \lambda_1)}{2\lambda_1 - \sin(2\lambda_1)} \exp(-\lambda_1^2 Fo) \quad (3.27)$$

Comparison of Eqs. (3.26) and (3.27) indicates that any off-centre temperature may simply be related to the centre temperature by the factor  $\zeta_1$  (Eq. 3.25) which is independent of time. This is illustrated in Figure 3.4 which shows the cooling curves at the surface, mid-radius and centre of a sphere.

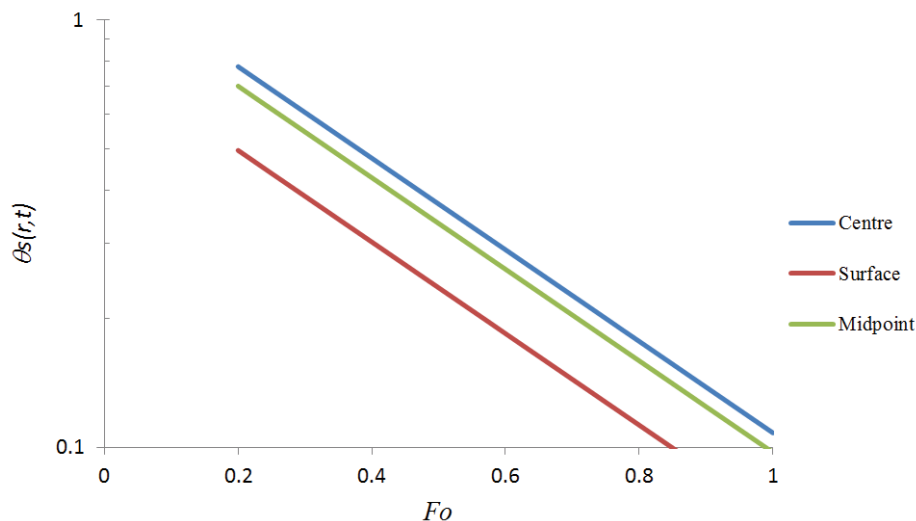

**Figure 3.4.** Cooling curves at the centre, mid-radius and surface of a sphere with  $Bi = 1$ .

Figure 3.4 shows that when the cooling curves at different positions are plotted as  $\ln \theta$  vs.  $t$ , they are parallel lines with different  $y$ -intercepts. The effect of the  $\zeta$  function in Eq. 3.20 is to move the cooling curve up or down, depending on how far off centre the point of interest is.

**Example 3.3:** An orange may be approximated as a perfect sphere having the thermal properties of water and a radius of 40 mm. If the orange is initially at a uniform temperature of 25 °C and it is placed in a refrigerator in which the air is maintained at 4 °C calculate:

- the time for the temperature at the centre of the orange to reach 10 °C
- the temperature at the surface at this time. Use the following data:  $h = 45 \text{ W m}^{-2} \text{ K}^{-1}$ ,  $k = 0.6 \text{ W m}^{-1} \text{ K}^{-1}$ ,  $\rho = 999 \text{ kg m}^{-3}$ ,  $C_p = 4180 \text{ J kg}^{-1}$ .

**Solution: a)** To determine the time required for the centre temperature to reach 10 °C, we use Eq. 3.27 where  $Fo$  (effectively the dimensionless time) is the unknown value. We can then solve for  $t$  from the definition of  $Fo$  (Eq. 3.21). However, in order to use Eq. 3.27 we will need to know the value of  $\lambda_1$ , which we can obtain from the  $Bi$  number via Eq. 3.23.

$$Bi = \frac{hR}{k} = \frac{45 \times 0.04}{0.6} = 3$$

$$\Rightarrow \lambda_1 = 2.8895 \text{ (Eq. 3.23 via iteration)}$$

From the temperature data supplied

$$\theta_{sph}(0,t) = \frac{T(0,t) - T_\infty}{T_i - T_\infty} = \frac{10 - 4}{25 - 4} = 0.2857$$

From Eq. 3.24

$$\psi_1(\lambda_1) = \frac{4(\sin 2.8895 - 2.8895 \cos 2.8895)}{2 \times 2.8895 - \sin(2 \times 2.8895)} = 1.6227$$



Discover the truth at [www.deloitte.ca/careers](http://www.deloitte.ca/careers)

**Deloitte.**

© Deloitte & Touche LLP and affiliated entities.



Rearranging Eq. 3.27:

$$Fo = \frac{-1}{\lambda_1^2} \ln\left(\frac{\theta(0,t)}{\psi_1}\right) = \frac{-1}{2.8895^2} \ln\left(\frac{0.2857}{1.6227}\right) = 0.3315$$

Rearranging Eq.3.21:

$$\begin{aligned} t &= \frac{\rho C_p R^2 Fo}{k} = \frac{999 \times 4180 \times 0.04^2 \times 0.3315}{0.6} \\ &= 3691 \text{ s} \\ &\approx 1 \text{ hour} \end{aligned}$$

Hence we predict that it will take about an hour for the centre of the orange to reach 10 °C. Note that the fact that  $Fo > 0.2$  in this problem validates our use of Eq. 3.27 rather than Eq. 3.20, and has saved us the trouble of calculating  $\lambda_2, \lambda_3, \dots, \psi_2, \psi_3, \dots$  etc.

**b).** To calculate the temperature at the surface (i.e. when  $r = R$ ) of the orange after 3691 s we observe that:

$$\theta_{sph}(R,t) = \theta_{sph}(0,t) \frac{\sin(\lambda_1 R/R)}{\lambda_1 R/R} = \theta_{sph}(0,t) \frac{\sin(\lambda_1)}{\lambda_1} = 0.2857 \times \frac{\sin 2.889}{2.889} = 0.0940$$

Hence:

$$\begin{aligned} \theta_{sph}(R,t) &= \frac{T(R,t) - T_\infty}{T_0 - T_\infty} = 0.0940 \\ \therefore T(R,t) &= \theta_{sph}(R,t)(T_0 - T_\infty) + T_\infty = 0.0940 \times (25 - 4) + 4 = 5.97^\circ\text{C} \end{aligned}$$

The heat load for a cooling sphere without phase change and for  $Fo > 0.2$  is given by:

$$\dot{Q}_{sph}(t) = \left[ 1 - 3\theta_{sph}(0,t) \frac{\sin \lambda_1 - \lambda_1 \cos \lambda_1}{\lambda_1^3} \right] \frac{4\pi R^3}{3} \rho C_p (T_i - T_\infty) \quad (3.28)$$

Similar expressions for dimensionless temperature and heat flow may be obtained for the long cylinder and the plane wall, and may be found in the sources cited at the end of the chapter.



While some items that might be placed in a refrigerated environment might be approximately spherical or cylindrical, most of them will have irregular geometries. The mathematics that would be required for analytical models of the cooling process would be excessively complex to be worthwhile; however, it is actually possible to treat the effects of geometry empirically, and independently of the effects of time. This may be seen by plotting the cooling curves of the three simple geometries (sphere, long cylinder and plane wall) for  $Bi = 1$  (i.e. same dimensions, physical properties and heat transfer coefficient for each shape), as shown in Figure 3.5.

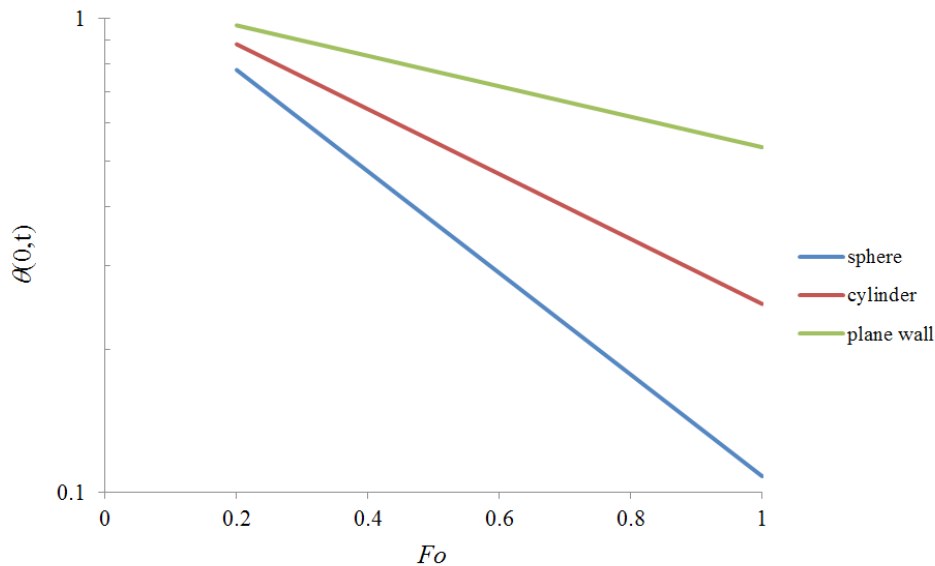

**Figure 3.5.** Cooling curves for sphere, long cylinder and plane wall with  $Bi = 1$ .

Figure 3.5 illustrates that the cooling curve for a long cylinder or plane wall could be obtained by applying a constant ‘shape factor’ to the cooling curve of the sphere (and, in fact, another factor applied to the  $y$ -intercept) provided the radius of the cylinder and the half-thickness of the wall are the same as the radius of the sphere. Hence, any geometry can have empirical shape factors determined by relatively simple experimentation; a point that will be expanded on in Chapter 6.

### 3.5 Summary of Chapter 3

While Thermodynamics allows us to perform calculations about the necessary temperatures pressures and heat flows in refrigeration problems, we need the separate discipline of Heat Transfer to allow us to size the heat exchangers of a refrigeration system, and also to determine the transient temperatures and heat loads of products being placed in the refrigeration system to be cooled.

For the former problem we used steady-state heat transfer analyses and arrived at the heat exchanger equation:

$$\dot{Q} = UA\Delta T_{LM}$$

(Similar expressions to the heat exchanger equation may also be used to model heat infiltration into the refrigerated environment.)

For the latter problem we used transient heat transfer analysis and arrived at the following expression:

$$\theta(r,t) \equiv \frac{T(r,t) - T_\infty}{T_0 - T_\infty} = \sum_{n=1}^{\infty} \psi_n(\lambda_n) \exp(-\lambda_n^2 Fo) \zeta_n(\lambda_n, r)$$

which may be greatly simplified by a number of assumptions, and where  $\psi$  and  $\zeta$  (if needed) may be determined empirically. More details about the use of these models may be found in the Further Reading section.

### 3.6 Further Reading

*ASHRAE Handbook: Refrigeration*, American Society of Heating, Refrigeration and Air Conditioning Engineers, Atlanta, 2010

Çengel, YA & Ghajar, AJ, *Heat and Mass Transfer: fundamentals and applications*, 4<sup>th</sup> Ed., McGraw Hill, New York, 2011

Hundy, GF, Trott, AR & Welch, TC, *Refrigeration and Air Conditioning*, 4<sup>th</sup> Ed., Butterworth Heinemann, Oxford, 2008

Stoecker, WF & Jones, JW, *Refrigeration and Air Conditioning*, 2<sup>nd</sup> Ed., McGraw Hill, New York, 1986

# 4 Refrigerants

The vast majority of refrigerators, heat pumps and air conditioners use the vapour compression cycle – the vapour that gives its name to the cycle is a *working fluid* called the *refrigerant* (even for heat pumps and air conditioners). Of course it is possible to achieve mechanical cooling without a refrigerant, but these devices make up only a very small percentage of all refrigerators, and will be dealt with in a Chapter 5.

So what is required for a substance to be a refrigerant? It turns out that almost any fluid can be used in a mechanical refrigeration cycle, including common-place ones such as air, water and carbon dioxide. However, some perform better than others; and of course most readers will be aware of environmental considerations such as the ozone layer and the greenhouse effect. So how does one select the best refrigerant for a task?

## 4.1 Desirable Attributes of Refrigerants

Generally speaking there are three basic categories of attributes we desire of our refrigerants:

1. Performance (efficiency, compatibility, cost)
2. Safety
3. Minimal environmental impact

SIMPLY CLEVER

ŠKODA



We will turn your CV into  
an opportunity of a lifetime



Do you like cars? Would you like to be a part of a successful brand?  
We will appreciate and reward both your enthusiasm and talent.  
Send us your CV. You will be surprised where it can take you.

Send us your CV on  
[www.employerforlife.com](http://www.employerforlife.com)



Click on the ad to read more

#### 4.1.1 Performance

The first aspect of performance is thermodynamic efficiency; we would like the refrigerant to have a high critical point and low triple point so that it can operate within the vapour-liquid region of the phase diagram (and hence have sufficient phase change in both the condenser and evaporator), and high enthalpies of vaporisation so that each gram of refrigerant can transport large quantities of heat. These two criteria might lead us to look at small, polar molecules: small for large specific enthalpies of vaporisation, and polar for higher critical points. One such molecule that fits this description is ammonia, which is indeed one of the most efficient refrigerants, and has been used consistently almost since the dawn of mechanical refrigeration. However, it does not do so well in the safety criteria, as will be discussed later.

But there other desirable physical attributes: we want a relatively high density of the vapour at the compressor inlet to minimise the work requirement, we would like high thermal conductivity for heat transfer, and we typically require miscibility with the lubricating oil of the compressor. We also need the refrigerant to be chemically stable so that its performance doesn't change over time, or worse still, produce detrimental by-products. We want it to be non-corrosive, so that we do not need to pay for expensive, corrosion-resistant materials of construction for our refrigerator. Finally, of course, we need the refrigerant itself to be relatively cheap.

#### 4.1.2 Refrigerant Safety

Ammonia performs excellently in a wide range of refrigeration applications; however, it is highly flammable and toxic, which means it is not suitable in domestic settings, or in devices which are susceptible to leakage, such as automobile air-conditioners. Clearly we would prefer non-flammable, non-toxic refrigerants. In the 1930s Thomas Midgley discovered that a class of compounds containing one or two carbon atoms, with varying numbers of chlorine and fluorine atoms attached were very effective refrigerants. These chemicals, later to be referred to as chloro-fluoro-carbons, or CFCs seemed to be ideal; they had desirable thermodynamic properties, and they were non-toxic, non-flammable and non-corrosive. For 50 years or so they were used abundantly, particularly R11 (trichlorofluoromethane  $\text{CCl}_3\text{F}_2$ ), R12 (dichlorodifluoro-methane  $\text{CCl}_2\text{F}_2$ ) and R22 (Chlorodifluoromethane,  $\text{CHClF}_2$ ). In the late 1970s, however, scientists Rowland and Molina argued that the chlorine in CFCs was destroying ozone in the stratosphere. After some initial opposition, this theory was accepted as being correct and Rowland and Molina shared the Nobel Prize in 1995 for their work. Clearly while being efficient and safe in terms of direct exposure to humans, CFCs have a negative environmental impact.

### 4.1.3 Environmental Impact

There are two aspects of the environmental impact of a refrigerant; firstly there is the direct impact of the refrigerant leaking from a system and escaping to the atmosphere; secondly there is also the impact from the extra carbon load on the environment from the extra fossil-fuel that needs to be burned by a less-efficient refrigerant compared to a more efficient refrigerant. There are two major measures of the environment impact of a refrigerant: the ozone depleting potential (ODP) and the Global Warming Potential (GWP). The ODP is based solely on the impact of the release of the refrigerant into the atmosphere; however the GWP is based not only on the direct release of the refrigerant into the atmosphere, but also the energy consumption for a given refrigeration load by that particular refrigerant. Sometimes the term Total Equivalent Warming Impact (TEWI) is used in GWP calculations.

In 1987 the Montreal Protocol was signed by a large number of countries, and the phase-out of refrigerants containing chlorine began in order to protect the ozone layer, and has continued successfully, to the point that CFCs have almost disappeared from use in the Developed World. How could they be replaced? Ideally, 'drop-in' replacements could be found such that an existing refrigeration system could be drained of its old, CFC refrigerant and be replaced by a non-CFC. One highly successful example was R134a (1,1,1,2-Tetrafluoroethane,  $\text{CH}_2\text{FCF}_3$ ) as a drop-in replacement for R12; however being a compound containing fluorine (a so-called 'F-gas'), which have direct GWP values of several thousand times that of carbon dioxide, its use has been scheduled for phase-out by signatories of the Kyoto Protocol. So what's left? Ammonia is efficient and environmentally friendly, but hazardous. CFC's are efficient and safe but destroy the ozone. F-gases such as R134a are efficient and safe but apparently contribute significantly to global warming. Which refrigerants are suitable in the modern age?

## 4.2 Refrigerants after the Montreal and Kyoto Protocols

To date no single refrigerant has been discovered that satisfies all the criteria desired of the ideal refrigerant. Perhaps R12 came the closest to being the ideal refrigerant before its environmental impacts were discovered, but since then no single compound can claim to be as dominant as it once was. Instead different refrigerants tend to be used for different tasks; the common ones are discussed briefly here.

### 4.2.1 Ammonia

Ammonia, as mentioned previously, was one of the very first refrigerants to be used with the vapour compression cycle. It has been in continuous use since then, although its popularity saw a decline in the middle of the 20<sup>th</sup> century due to the widespread use of CFCs. Since the signing of the Montreal Protocol, however, its use has recovered. As discussed above, it fares very well against the performance criteria but poorly in the safety criteria. However, given that it is part of the nitrogen cycle it performs excellently again against the environmental criteria, having both zero ODP and zero GWP.

Today it is the dominant refrigerant on the industrial scale, thanks to its high efficiency, low cost and minimal environmental impact. With advances in the design of refrigeration components, leakage is less of a problem. In addition, the use of non-flammable secondary refrigerants (i.e. refrigerants that are cooled by the primary refrigerant, before in turn cooling the load) has reduced safety concerns where flammability is a significant risk.

#### 4.2.2 Carbon Dioxide

Like ammonia, carbon dioxide was one of the first refrigerants to be used in the vapour-compression cycle; however it is not as efficient as ammonia, having quite a low critical point. It performs better than ammonia against the safety criteria, being non-flammable and less toxic (although it may still cause fatal poisoning), and has zero ODP and relatively low (some would argue zero) direct GWP. It disappeared from widespread use after the advent of the CFCs in the 1930s, but in recent years has made a strong recovery with the development of the trans-critical vapour-compression cycle. Its use is predicted to increase, both for low temperatures on the industrial scale, and also for commercial use, such as in supermarket display cabinets.

I joined MITAS because  
I wanted **real responsibility**

The Graduate Programme  
for Engineers and Geoscientists  
[www.discovermitas.com](http://www.discovermitas.com)





**Month 16**  
I was a construction  
supervisor in  
the North Sea  
advising and  
helping foremen  
solve problems

Real work  
International opportunities  
Three work placements





### 4.2.3 Hydrocarbons

Like carbon dioxide, hydrocarbons were tested as refrigerants before the introduction of CFCs, but their high flammability saw them fall out of favour. They too have seen more widespread use since the Montreal and Kyoto Protocols to the point where iso-butane (R600a,  $\text{CH}(\text{CH}_3)_3$ ) in particular is widely used in domestic refrigeration in Northern Europe. It has been predicted that the use of hydrocarbon refrigerants will increase in the future as safety features of refrigeration systems are improved.

### 4.2.4 Hydro-fluorocarbons (HFCs)

As the chosen successor to R12, R134a is still in widespread use, particularly for smaller applications such as domestic refrigerators and domestic and automobile air conditioners. Because it has high GWP, there has been pressure for its phase-out by signatories of the Kyoto Protocol, but since there are many countries who are not signatories, its use (along with other HFCs) looks set to continue for several years to come.

### 4.2.5 Blends

Refrigerant blends have been used since the time of CFCs, as people attempted to tailor the performance and safety of the refrigerant to meet a desired task. For example, an efficient but flammable refrigerant may be blended with a slightly less-efficient, non-flammable refrigerant to reduce the overall flammability of the mixture.

Ideally azeotropic mixtures (i.e. those whose composition does not vary between the liquid and vapour phases) should be used, since their properties are not altered as a result of leakage. Common examples of blended refrigerants are R502, which is a blend of the CFCs R22 and R115 ( $\text{CClF}_2\text{CF}_3$ ) and R404A, which is a blend of the HFCs R134a, R143a ( $\text{CH}_3\text{CF}_3$ ) and R125 ( $\text{CHCF}_3$ ). HFC blends continue to be used in commercial refrigeration, but are subject to political pressure for their phase-out.

## 4.3 Summary of Chapter 4

The ideal refrigerant has a high critical point, high enthalpy of vaporisation, is miscible with lubricating oil, is cheap, is non-flammable, is non-toxic, has zero ODP and GDP, amongst other desirable criteria. Unsurprisingly, perhaps, no single refrigerant satisfies all these desirable criteria. Since the signing of the Montreal and Kyoto Protocols, the trend has been away from the synthetic, chlorine and fluorine-containing refrigerants towards natural refrigerants such as ammonia, carbon dioxide and hydrocarbons. Some synthetics, R134a in particular, look set to remain in widespread use for the foreseeable future.

## 4.4 Further Reading

Hundy, GF, Trott, AR & Welch, TC, *Refrigeration and Air Conditioning*, 4<sup>th</sup> Ed., Butterworth Heinemann, Oxford, 2008

Pearson, SF, *Refrigerants Past, Present and Future, Proceedings of the 21<sup>st</sup> International Congress of Refrigeration*, Washington DC, 2003

# 5 Refrigeration without a Refrigerant

If a sufficiently cold natural environment is not available to cool an object, then in order to achieve a cooling effect one has to be able to change a body's temperature without the transfer of heat (since heat will only flow from a higher temperature to a colder temperature). The vapour compression and sorption refrigeration cycles rely on gas expansion to reduce the temperature of the refrigerant. However, there are several other options.

## 5.1 Evaporative cooling

The human body is cooled by water (sweat) evaporating from the skin. This same principle may be applied to achieve air cooling, and is particularly effective in dry climates. There are indications from ancient paintings that as early as the time of the Pharaohs in Egypt evaporative cooling was used in homes, as earthenware pitchers were filled with water which saturated the clay and evaporated from the surface. Today there is a thriving commercial market for evaporative coolers, particularly for people who live on or near a desert.

Obviously, evaporative cooling is limited to a relatively narrow range of temperatures, and is most effective for air-conditioning applications. The cooling effect is directly proportional to the difference in humidity between the air before and after it is sprayed with water, so evaporative cooling will not be feasible in humid climates. The reader might argue that the water used in evaporative cooling *is* a refrigerant; however, it is not a working fluid in the common sense of the term, which is why it is included in this chapter.

In a dry climate, all that is needed for an evaporative cooling system is water source, a small pump to pass the water through an atomising nozzle, and a fan to circulate the cooled air. Misting fans are an example of a very simple, portable evaporative cooling device.

In very dry climates the increased humidity of the air from the water spray adds to human comfort. In climates that are not particularly dry the air will most likely need to be dehumidified prior to being sprayed with water in order that there is a sufficient driving force for the evaporation process, and also to prevent the need to humidify the air above 85%, which would make it uncomfortable to humans. Often desiccant systems are used for dehumidification, sometimes in the form of wheels, and sometimes in the form of stationary beds. The addition of the dehumidifying process increases the power requirement of the fan, since the pressure drop through the desiccant will be significant. Also, the desiccant will need to be regenerated, typically by heating. A number of prototype devices have been developed which use photovoltaics to drive the pump and fan, and solar thermal energy to regenerate the desiccant, thereby producing a stand-alone system, even in climates with moderate humidity.



The advantage of evaporative cooling over vapour-compression air-conditioning is the relatively low running cost, since no gas is being compressed (the water pump and fan use orders of magnitude less energy than a compressor), and often very low installation and maintenance cost.

The disadvantages, apart from the requirement of low humidity and a narrow range of temperatures, are that warm, still water is an ideal breeding environment place for insects, such as mosquitoes and bacteria, such as legionella which causes Legionnaires Disease. For this reason a number of systems use indirect cooling, enclosing the sprayed water via a heat exchanger so that any potential contaminants won't be breathed in by humans. Indirect systems are less efficient and more complex, which is the trade-off for their increased safety.

## 5.2 Peltier-Seebeck effect (thermoelectric devices)

The Peltier-Seebeck effect describes the relationship between temperature and voltage that occurs when two dissimilar conductors (typically metals) are connected at two separate junctions. If the two junctions are held at dissimilar temperatures then a voltage difference will exist between the two junctions, and this phenomenon is known as the *Seebeck* effect. The Seebeck effect may be used to measure temperature since the voltage generated is proportional to the temperature difference between the two junctions. Temperature sensors that make use of the Seebeck effect are known as *thermocouples*, and they are typically cheap and very versatile; although are not as accurate as resistance thermometers.

**ie business school**

#1 EUROPEAN BUSINESS SCHOOL  
FINANCIAL TIMES 2013

**#gobeyond**

**MASTER IN MANAGEMENT**

**Because achieving your dreams is your greatest challenge.** IE Business School's Master in Management taught in English, Spanish or bilingually, trains young high performance professionals at the beginning of their career through an innovative and stimulating program that will help them reach their full potential.

- Choose your area of specialization.
- Customize your master through the different options offered.
- Global Immersion Weeks in locations such as London, Silicon Valley or Shanghai.

**Because you change, we change with you.**

www.ie.edu/master-management | mim.admissions@ie.edu |

Alternatively the voltage generated by the Seebeck effect may be used to run a motor. A large number of thermocouples grouped together and operating between the same temperatures is known as a *thermopile*, and may be used to measure temperatures, or as a *thermo-electric engine*. A thermo-electric engine is one which employs the Seebeck effect to generate work from a sustained temperature difference. For example, if a thermal hot spring exists close to a cold river, a thermo-electric engine might be used to power a fan simply by having one junction in the hot spring and the other junction in the cold river.

The *Peltier effect* is essentially the Seebeck effect in reverse. If a voltage difference is applied between the two junctions of a thermocouple, one junction will increase in temperature while the other junction will decrease in temperature. The low temperature junction of the Peltier cooling is maintained by the continuous supply of power, even as it absorbs heat from its surroundings. Thus the Peltier effect offers us an incredibly simple cooling method, and allows us to produce cooling devices having no moving parts, which can be of any size or shape. Peltier coolers have a wide range of niche applications, particularly in electronics and in research laboratories.

Figure 5.1 shows a demonstration model of a thermo-electric device at the University of Waikato. The thermo-electric unit (thermocouple) is sandwiched between two aluminium legs. If the device is switched to the 'engine' setting, then the fan will run if one leg is placed in ice water and the other is placed in boiling water. If the device is switched to the 'Peltier' setting and a DC power supply (up to 5V for this device) is attached to the electrodes, then one of its legs will increase in temperature, while the other will decrease.

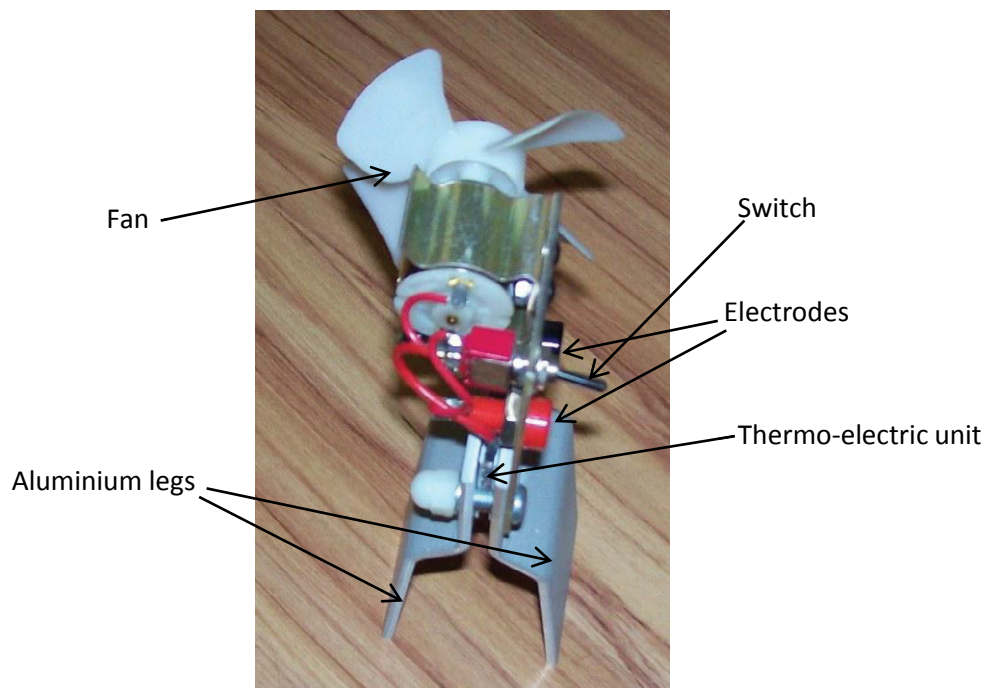

**Figure 5.1:** Thermo-electric device

So why are Peltier coolers not in more common use? The simple answer is they have very low thermodynamic efficiency – of the order of 10–15 % of Carnot efficiency. This limits their application to the small scale, where their inefficiency is more than compensated by their practicality. Some commercial units are available and research efforts are continuing with the goal of increasing their efficiency, but in the foreseeable future, they will be limited to small, niche applications.

### 5.3 Magneto-Calorific Effect (Magnetic Refrigeration)

The magneto-calorific effect describes changes in the temperature of a (solid) medium when it is placed in a changing magnetic field. The temperature change occurs as a result of the entropy reduction that is caused by the magnetic dipoles of the atoms in the solid coming into alignment as a result of the applied magnetic field. Alloys of the element gadolinium (Gd) show a particularly noticeable temperature change when a magnetic field is applied.

To exploit the magneto-calorific effect in a refrigeration cycle, the magneto-calorific material (often in the form of a rotor) is successively exposed to magnetic fields and heat exchange environments in an analogous manner to the vapour compression cycle. Beginning with the rotor in an unmagnetised state at low temperature, the rotor is magnetised adiabatically (i.e. in an insulated environment) such that its temperature increases (analogous to the adiabatic compression process). At the end of the magnetisation process the rotor enters a heat exchanger where it rejects its heat in an isomagnetic state (analogous to the condensation process). Subsequently it is de-magnetised adiabatically, which lowers its temperature (analogous to the expansion process). Finally it absorbs heat at the lower temperature (analogous to the evaporation process), before the cycle is repeated.

Magnetic refrigeration saw its earliest practical use in low-temperature (cryogenic) applications; however, more recently a lot more effort has been put into developing units for room-temperature. By contrast with thermo-electric devices, magnetic refrigerators can be very thermodynamically efficient, provided the heat absorption and heat rejection temperatures do not vary too significantly. This efficiency, along with the fact that there is no refrigerant vapour to escape into the atmosphere means that magnetic refrigeration is a very environmentally friendly option. It is also very quiet, since there is no compressor, and like thermo-electric devices has relatively few moving parts. For these reasons there are hopes that the technology will continue to be developed to the point that it may one day become the standard method of refrigeration in small-scale applications such as in domestic settings or automobile air-conditioning.

However, the magnetic refrigerator does suffer disadvantages, particularly when compared to the vapour compression cycle. The temperature difference between magnetised and unmagnetised states is limited which means that if there is a significant difference between the heat absorption and heat rejection temperatures then a cascade design may have to be employed. Permanent magnets also have limited field strength, which imposes a relatively low upper limit to the rate at which heat may be absorbed, since electro-magnets would make the overall cost restrictive. But perhaps the biggest restriction is due to the low rates of heat transfer that occur in the heat exchangers, where rates are orders of magnitude lower than rates encountered with evaporating liquids and condensing vapours. Also the heat is not transferred isothermally, as is mostly the case in evaporators and condensers, which greatly reduces the logarithmic mean temperature difference of each exchanger. For these reasons, even if magnetic refrigeration devices come in to common usage, it is probable that they will be limited to small applications.

#### 5.4 Thermo-acoustic effect (acoustic refrigeration)

Inasmuch as sound waves are fluctuations in pressure within a fluid medium (usually a gas), there will be temperature fluctuations associated with these pressure fluctuations. If the pressure fluctuations can be made to be large enough, the accompanying temperature fluctuations may be exploited to achieve refrigeration.



## STUDY AT A TOP RANKED INTERNATIONAL BUSINESS SCHOOL

Reach your full potential at the Stockholm School of Economics, in one of the most innovative cities in the world. The School is ranked by the Financial Times as the number one business school in the Nordic and Baltic countries.

Visit us at [www.hhs.se](http://www.hhs.se)





A schematic of an acoustic refrigerator is shown in Figure 5.2. An ultrasonic, high-amplitude sound generator (essentially an audio speaker) is placed at one end of a pressurised resonator tube and is used to generate a standing wave. The length of the resonator tube is designed to be one half-wavelength of the generated sound wave at the desired frequency (hence the effect is analogous to plucking a guitar string). Near the sound generator end of the tube is a stack of parallel, low-conductivity plates that make up the *regenerator*.

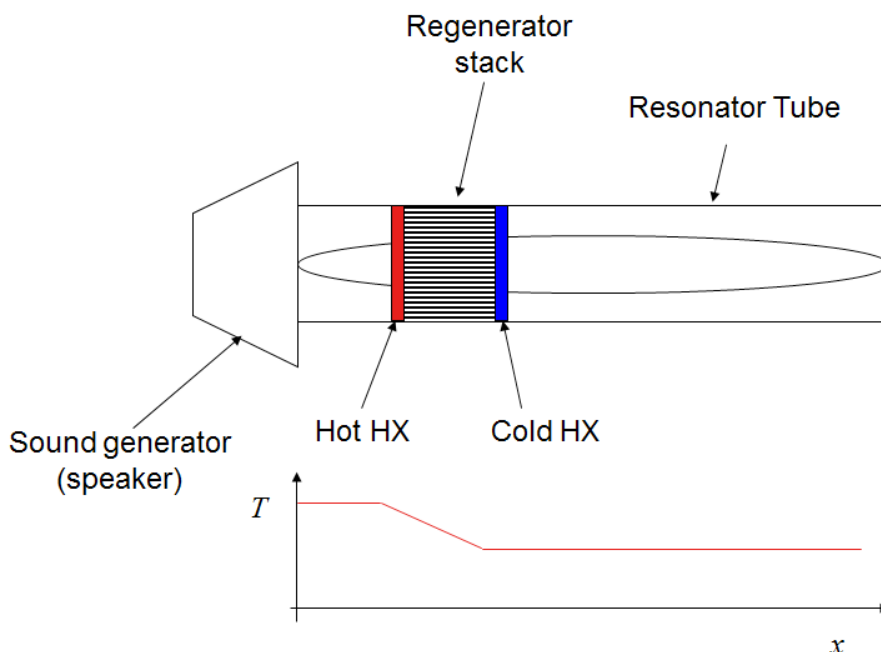

Figure 5.3: Schematic of an acoustic refrigerator

Let us consider what happens to a small volume of gas as it travels between the regenerator plates. As the soundwave moves the volume from the cold side of the stack to the hot side it is compressed adiabatically, and so its temperature increases so that it can exchange heat with the fluid in the hot heat exchanger at constant pressure (isobarically but not isothermally), but with a loss in temperature. The gas is then moved back from the hot side to the cold side and expands adiabatically so that it is at a lower temperature than the heat exchange fluid in the cold heat exchanger, where again it transfers heat isobarically, and the cycle repeats.

In principle, the thermodynamic efficiency of acoustic refrigerators could be very high, and like Peltier coolers and magnetic refrigerators they have few moving parts and have no refrigerant to cause ozone depletion or global warming. However, in practice their performance is greatly limited by the efficiency of the heat exchangers, which, similar to magnetic refrigerators, suffers from low heat transfer rates and low logarithmic mean temperature differences, and so its application would be limited to the small scale. Currently it is not considered to be as promising an alternative to vapour compression as magnetic refrigeration.

## 5.6 Summary of Chapter 5

There are alternatives to refrigerants for achieving cooling effects; however, none can compete with the vapour compression cycle for medium to large scale application or for wide temperature ranges. Evaporative cooling and thermo-electric devices each have their niche and magnetic refrigeration is expected to gain popularity in the near future. Thermo-acoustic devices are largely only at the development stage.

## 5.7 Further Reading

Paek, I, Braun, JE & Mongeau, L, Evaluation of standing-wave thermoacoustic cycles for cooling applications, *International Journal of Refrigeration*, 30, 1059–1071, 2007

Qureshi, BA & Zubair, SM, A comprehensive design and rating study of evaporative coolers and condensers. Part I. Performance evaluation, *International Journal of Refrigeration*, 29, 645–658, 2006

Vasile, C & Muller, C, Innovative design of a magnetocaloric system, *International Journal of Refrigeration*, 29, 1318–1326, 2006

Wetzel, M & Herman C, Design optimization of thermoacoustic refrigerators, *International Journal of Refrigeration*, 20, 3–21, 1997

Yu, BF, Gao, Q, Zhang, B, Meng, XZ, & Chen Z, Review on research of room temperature magnetic refrigeration, *International Journal of Refrigeration*, 26, 622–636, 2003

Zhang, HY, A general approach in evaluating and optimizing thermoelectric coolers, *International Journal of Refrigeration*, 33, 1187–1196, 2010

# Part 2: Applications



(  
Photo Courtesy of Fisher & Paykel Appliances Ltd)

## 6 Chilling and Freezing

Food preservation is required due to the fact that there is typically a time lag between when a food is harvested and when it is consumed. Grains, fruits and vegetables, and animal products tend to be produced seasonally, while their consumption is relatively steady year-round. And even if production was steady, due to urbanisation time is required for the food to be transported from the rural areas where it is produced to the cities where the majority of it is consumed. Without some means of preservation, foods, particularly those with high moisture contents, are susceptible to contamination from micro-organisms including yeasts, moulds, fungi, bacteria and viruses. Even in the absence of foreign microbes, foods may still spoil due to the activity of enzymes and other biochemical processes within the food itself.

Worldwide, refrigeration and drying are probably the most common methods for preserving food. Refrigeration achieves preservation by lowering the temperature such that microbial populations do not grow at significant rates, and biochemical processes are slowed. Drying achieves preservation by lowering the moisture content to a point at which most microbes cannot survive. Of these two techniques, however, refrigeration has much less impact on the colour, structure and flavour of the food, and is therefore preferred as a preservation means for most foods, particularly in the Developed World. Drying (particularly sun-drying) is a lower-cost alternative for Developing Countries, particularly in rural settings.



**#1**  
in eco-friendly  
attitude

**STUDY AT  
LINKÖPING UNIVERSITY, SWEDEN**  
RANKED AMONG TOP 50 UNIVERSITIES UNDER 50

Interested in Strategy and Management in International Organisations? Kick-start your career with a master's degree from Linköping University, Sweden.

→ **Click here!**

 **Linköping University**



It has been estimated in that in the first decade of the 21<sup>st</sup> Century about 360 million tonnes of perishable food was lost every year due to insufficient use of refrigeration, or poorly designed refrigeration systems. With the world's population continuing to increase, and all the available arable land currently being used, refrigeration is going to be relied on more and more to reduce wastage and ensure the world's population is sufficiently nourished.

Food refrigeration is typically separated into two categories depending on whether any ice forms. Refrigeration to temperatures above the initial freezing point of food is called chilling; refrigeration below the initial temperature of the food is called freezing. The reason for this distinction is that it is often vital for the quality of the food that it is treated properly, e.g. most fruits and vegetables will suffer irreversible tissue damage if ice crystals are formed, and hence they must not be frozen. The physical mechanisms involved in chilling and freezing are also quite different, which is a further reason to analyse them separately.

By contrast with the domestic situation, industrially, the process of temperature reduction ('chilling' or 'freezing') is often (but not always) performed in a different device/room than the process of temperature maintenance ('cool' or 'cold storage'). Typically a devoted chiller/ freezer will have a relatively small product space, and relatively large refrigeration unit, while the cool/cold store will have a higher product space and comparatively small refrigeration unit.

## 6.1 Estimating Chilling times of food products

Once raw foods have been harvested (here 'harvesting' is used as an inclusive term for all foods meaning the process of extracting them from their natural environment) there is usually a relatively narrow window during which time they must be cooled from their harvested temperature to the storage or further processing temperature. Generally the cooling process is as fast as possible; however, the biochemical/ physiological make up of some foods places an upper limit on the rates at which they may be cooled. As will be discussed in Chapter 7, different foods have different requirements, and it is important that each type of food is cooled optimally in order to reduce product wastage, and maximise profit for the producer. It is helpful if we have some way to predict how long a food product will take to cool under certain conditions since this will help us to design or select a suitable cooling regime.

Recall that in Chapter 3 we discussed the cooling of regularly shaped objects, and mentioned that irregularly shaped objects could be modelled in a similar manner. For liquid foods we may simply use Eq. 3.16 (Chapter 3), provided we can determine the value of  $h$  (which may often be measured by performing a relatively straightforward experiment). For highly viscous or solid foods we use modified forms of Eq. 3.20 or, preferably, only the first term of the infinite series:

$$\theta(r,t) \equiv \frac{T(r,t) - T_\infty}{T_0 - T_\infty} = \psi_1(\lambda_1) \exp(-\lambda_1^2 Fo) \zeta_1(\lambda_1, r) \quad (6.1)$$

If we plot  $\ln\theta$  vs.  $t$  for  $Fo > 0.2$ , as we did in Figures 3.4 and 3.5, we will get straight lines, which may be modelled by:

$$\ln[\theta(r,t)] = a - b \cdot t \quad (6.2)$$

where  $a$  and  $b$ , the intercept and slope of the cooling curve, are functions of  $\lambda_1$ , i.e.

$$a = \ln(\psi_1) + \ln(\zeta_1) \quad (6.3)$$

$$b = -\frac{\lambda_1^2 k}{\rho C_p R^2} \quad (6.4)$$

From Eq. (6.2) we see that the influence of the object's shape (manifested by the parameters  $a$  and  $b$ ) can be treated independently from the effect of time. Hence for any shape, if we are able to determine these shape-related factors, we can use Eq. (6.2) as the cooling model, provided there is no phase change (i.e. chilling processes only).

The factors  $a$  and  $b$  can be determined empirically as a function of  $Bi$ , and this may be the simplest method for their determination for some shapes. Recall from Chapter 3 that the Biot number measures the relative resistance of heat transfer to or from the surface to the resistance to heat transfer from the centre of the object to its surface. It is a function of the product's thickness, its thermal conductivity and the heat transfer coefficient at the product's surface. Therefore, the range of  $Bi$  considered when measuring  $a$  and  $b$  should reflect the range of cooling conditions likely to be encountered (i.e. if the product is to be chilled in air, the range of  $Bi$  should reflect the range of air velocities likely to be encountered).

The cooling trials that would be required to determine  $a$  and  $b$  are relatively simple to perform; however, given the need to perform measurements over a range of  $Bi$ , a large number would need to be performed for a single product, which would be time-consuming and therefore expensive in a commercial setting. Fortunately, in many situations the slope and intercept of the cooling curve may be predicted. In practice a modified form of Eq. (6.2) is used:

$$\ln \theta(0,t) = \ln j_0 - 2.303t / f \quad (6.5)$$

The physical interpretation of the parameter  $f$  (often referred to as the ' $f$ -factor') is that it is the time required for the dimensionless temperature to decrease by a factor of 10 (which is why the factor 2.303, which is equal to  $\ln(10)$ , is present in Eq. (6.5)). Note that the  $j$ -factor is given a subscript '0' to indicate that it relates to the centre temperature, and a different factor will be required for off-centre temperatures. The  $f$ -factor applies regardless of position within the object, as is illustrated by the parallel slopes of the cooling curves at different positions in a sphere which is shown in Figure 3.4.

For the centre of a sphere, the  $f$  and  $j_0$  parameters may be determined by comparing Eq. (6.5) with Eq. (3.27):

$$j_0 = \frac{4(\sin \lambda_1 - \lambda_1 \cos \lambda_1)}{2\lambda_1 - \sin(2\lambda_1)} \quad (6.6)$$

$$f = \frac{2.303\rho C_p R^2}{k\lambda_1^2} \quad (6.7)$$

The  $f$  and  $j_0$  parameters for the long cylinder and plane wall may be determined in a similar manner; however, for more complex shapes the determination of  $f$  and  $j_0$  will not be as trivial an exercise. The literature contains several methods for predicting their values. The relatively simple procedure of Hayakawa and Villalobos for determining the centre and/or mass average temperature is outlined here (and is also covered in the ASHRAE Handbook of Refrigeration).

Firstly the object must be analysed in such a manner that the shortest distance ( $L$ ) between the centre and the surface is identified (the radius in the case of the sphere) and from this a factor  $P_1$  is defined:

$$P_1 = \frac{S_1}{\pi L^2} \quad (6.8)$$



"I studied English for 16 years but...  
...I finally learned to speak it in just six lessons"  
Jane, Chinese architect

ENGLISH OUT THERE

Click to hear me talking before and after my unique course download

where  $S_1$  is the cross-sectional area containing  $L$ . Next the area  $S_2$  containing  $L$  orthogonal to  $S_1$  is used to determine  $P_2$ :

$$P_2 = \frac{S_2}{\pi L^2} \quad (6.9)$$

In some situations it may be simpler to use an alternative definition for  $P_2$ :

$$P_2 = \frac{3V}{4\pi P_1 L^3} \quad (6.10)$$

Note that the values of  $P_1$  and  $P_2$  will be unity for a sphere. In essence this process seeks to compare the cooling rate of a particular shape with that of a sphere by introducing the appropriate shape factors. From  $P_1$  and  $P_2$  a geometry factor  $G$  is calculated:

$$G = 0.25 + \frac{3}{8P_1^2} + \frac{3}{8P_2^2} \quad (6.11)$$

The  $\lambda_1$  parameter may then be approximated from:

$$\begin{aligned} \ln(\lambda_1^2) = & 0.92083090 + 0.83409651 \ln(G) - 0.78765739 \ln(1/Bi) \\ & - 0.04821784 \ln(G) \ln(1/Bi) - 0.04088987 \ln(G)^2 - 0.10045526 \ln(1/Bi)^2 \\ & + 0.01521388 \ln(G)^3 + 0.00119941 \ln(G) \ln(1/Bi)^3 + 0.00129982 \ln(1/Bi)^4 \end{aligned} \quad (6.12)$$

Equation (6.12) applies for  $0.25 \leq G \leq 1.0$  and  $0.01 \leq Bi \leq 100$ . The  $j_m$  factor (the  $j$ -factor for the mass average temperature) can be estimated from Eq. (6.13):

$$j_m = 0.892 \exp(-0.0388 \lambda_1^2) \quad (6.13)$$

An estimate of the  $j_0$  may be obtained from  $j_m$  and vice versa.

To summarise this method the following steps should be taken to estimate the chilling time of a complex, or irregularly shaped food (provided  $0.01 \leq Bi \leq 100$ ):

1. Obtain thermal properties of food product and heat transfer coefficient of cooling fluid
2. Calculate  $Bi$  from Eq. (3.22) with  $R = L$  (the shortest distance between centre and surface)
3. Estimate  $S_1$  and  $S_2$  and calculate  $P_1$  and  $P_2$  from Eqs. (6.8) and (6.9)
4. Determine  $G$  from Eq. (6.11) and then  $\lambda_1^2$  from Eq. (6.12)
5. Calculate  $f$  from Eq. (6.7) with  $R = L$  and use Eq. (6.13) to calculate  $j$
6. Finally use a rearranged form of Eq. (6.5) to calculate the chilling time:

$$t = -\frac{f}{2.303} \ln\left(\frac{\theta}{j}\right) \quad (6.14)$$

An alternative approach which will not be presented here is to employ the *equivalent heat transfer dimensionality* (refer the ASHRAE Handbook of Refrigeration listed in the Further Reading Section) which is slightly more elaborate, but is based on parameters that may, in some cases, be easier to identify than  $L$ ,  $S_1$  and  $S_2$ .

For greater accuracy than may be expected from these semi-empirical methods for estimating chilling times, numerical methods are required. As might be expected, there are several software packages that have been developed specifically for calculating cooling times and heat loads. An example is the *Food Product Modeller*<sup>™</sup> package that has been developed by *AgResearch Ltd* in New Zealand.

**Example 6.1:** Estimate the time required for a cucumber which has a diameter of 70 mm and a length of 200 mm, to cool from an initial uniform temperature of 35 °C to a *mass average temperature* of 4 °C when placed in a refrigerator set to maintain an air temperature of 2 °C, assuming a heat transfer coefficient of 50 W m<sup>-2</sup> K<sup>-1</sup>.

**Solution:** It is useful in any transient heat transfer problem to calculate  $Bi$  initially. For irregular shapes the  $Bi$  is based on the shortest path from the centre to the surface of the object, and in this case is simply the radius. However, first we need to know the thermal conductivity of cucumber. Data for thermal properties of foods is available from a number of sources, including the *ASHRAE Handbook of Refrigeration* and the *Food Properties Handbook* (see Further Reading) especially for fruit vegetables, meat, poultry and dairy products. Where data are not available for a food (i.e. for a processed food), its thermal properties may be predicted from composition data, using models that are typically available from the same sources as the data. For high water-content foods such as fruits and vegetables, using the properties of water will often be suitable for a first approximation. In the case of cucumbers, data from the sources mentioned above are as follows:  $k = 0.59$  W m<sup>-1</sup> K<sup>-1</sup>,  $\rho = 950$  kg m<sup>-3</sup>,  $C_p = 4090$  J kg<sup>-1</sup> K<sup>-1</sup>. Hence:

$$Bi = \frac{hR}{k} = \frac{50 \times 0.035}{0.59} = 2.97$$

A schematic of the cucumber is shown in Figure 6.1, in which the areas  $S_1$  and  $S_2$  are indicated. We can assume that the cucumber has a perfectly circular cross-section in which case  $S_1$  will be equal to the cross-section area of a circle with a radius of 0.035 m, and  $P_1$  will be unity (by inspection of Eq. 6.8).

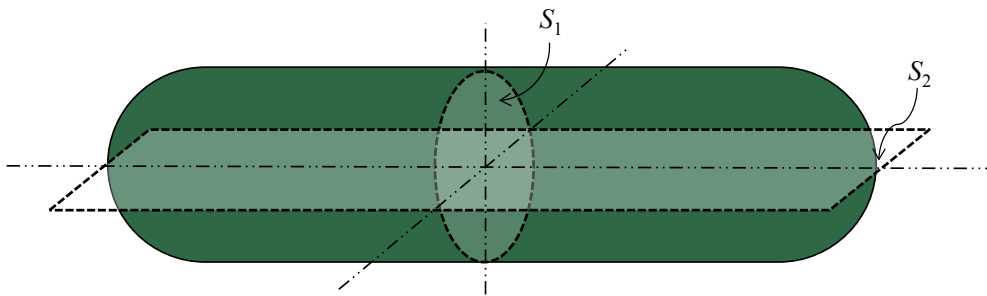

Figure 6.1: Schematic of the cucumber in Example 6.1

Cucumbers have rounded ends; however, since the length of the cucumber is several times greater than the diameter, the rate of heat transfer down the axis of the cucumber will not be as great as in the radial direction, so it will be sufficient for this sort of estimate to assume that the cross sectional area orthogonal to the cross-sectional area in the direction of the radius is simply the length of the cucumber multiplied by the diameter, i.e.:

$$S_2 = 0.25 \times 0.07 = 0.0175 \text{ m}^2$$

Excellent Economics and Business programmes at:



university of groningen



“The perfect start of a successful, international career.”

**CLICK HERE** to discover why both socially and academically the University of Groningen is one of the best places for a student to be

[www.rug.nl/feb/education](http://www.rug.nl/feb/education)

Hence, from Eq. 6.9:

$$P_2 = \frac{S_2}{\pi L^2} = \frac{0.0175}{\pi 0.035^2} = 4.55$$

From Eq. 6.11:

$$G = 0.25 + \frac{3}{8P_1^2} + \frac{3}{8P_2^2} = 0.25 + \frac{3}{8 \times 1^2} + \frac{3}{8 \times 4.55^2} = 0.643$$

From Eq. 6.12,  $\lambda_1^2 = 3.53$ .

From Eq. 6.7:

$$f = \frac{2.303 \rho C_p R^2}{k \lambda_1^2} = \frac{2.303 \times 950 \times 4090 \times 0.035^2}{0.59 \times 3.53} = 5270 \text{ s}$$

From Eq. 6.13:

$$j_m = 0.892 \exp(-0.0388 \lambda_1^2) = 0.892 \exp(-0.0388 \times 3.53) = 0.778$$

The dimensionless temperature is:

$$\theta = \frac{T(t) - T_\infty}{T_0 - T_\infty} = \frac{4 - 2}{35 - 2} = 0.0606$$

From Eq. 6.14:

$$t = -\frac{f}{2.303} \ln\left(\frac{\theta}{j}\right) = -\frac{5270}{2.303} \ln\left(\frac{0.0606}{0.778}\right) = 5840 \text{ s}$$

Hence we would expect the cucumber to take approximately 1½ hours to cool. Note that in this problem we considered a single cucumber being chilled. In reality cucumbers would be cooled in bulk, and the physical (i.e.  $k$ ,  $\rho$  and  $C_p$ ) and transport (i.e.  $h$ ) properties involved require more attention, but are beyond the scope of this text

## 6.2 Estimating heat loads of food products

Calculation of the heat load of a refrigeration process depends to some extent on the design of the refrigerator and in particular whether it is run under batch or continuous operation. For a continuous process (e.g. tunnel chiller where product passes through the chiller on a conveyer belt), it will probably be sufficient to divide the enthalpy change between the inlet and outlet by the residence time of the product in order to determine the average load:

$$\dot{Q} = \frac{\rho V C_p (T_i - T_\infty)}{t} \quad (6.15)$$

In reality the cooling load will vary along the length of the tunnel, but Eq. (6.15) will often be sufficient as an estimate.

For a batch process (e.g. a carcass chiller, where the carcasses are placed in a refrigerated room, left there for a length of time), it is helpful to be able to model time-variable load. This may be achieved based on parameters calculated when estimating the chilling time. The time-variable heating load up to the point in time where:

$$t = f \log_{10}(j_m / 0.7) \quad (6.16)$$

may be calculated from:

$$\dot{Q} = \rho V C_p (T_i - T_\infty) \frac{0.3}{f \log_{10}(j_m / 0.7)} \quad (6.17)$$

after which time:

$$\dot{Q} = \rho V C_p (T_i - T_\infty) 2.303 \exp\left(-\frac{2.303}{f}\right) \quad (6.18)$$

## 6.3 Freezing and Thawing Time Prediction

A standard temperature history (i.e. cooling curve) of a chilling process follows a relatively simple exponential decay curve, as illustrated in Figures 3.4 and 3.5. By contrast, the temperature history of a freezing process has cusps and cannot be modeled simply by a continuous function. Figure 6.2 shows the freezing curves at three different positions in a pail of strawberry pulp.



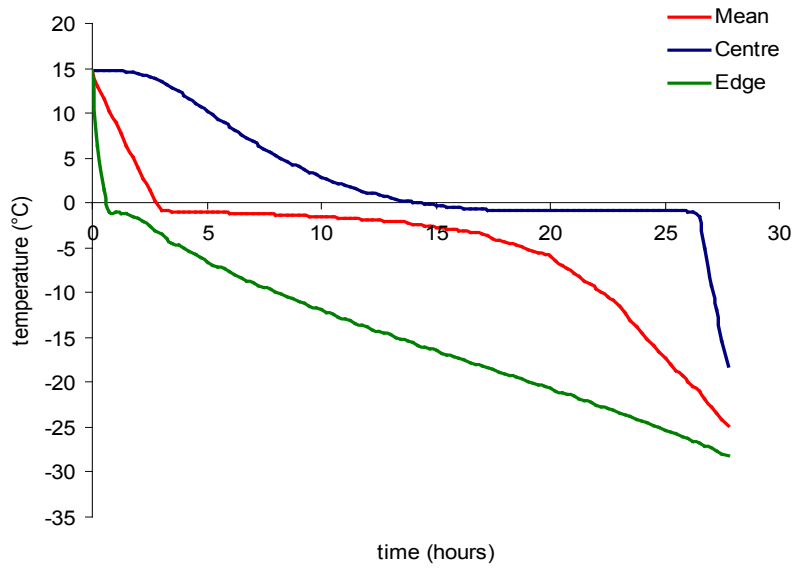



Figure 6.2: Temperature histories at three different locations in a pail of strawberry pulp

Initially, the freezing curves follow an exponential decay, since above the initial freezing temperature it is simply a chilling process. Note that unlike pure water which has a distinct freezing temperature above which water is in the liquid state and below which water is in the frozen state, the freezing point of a solution only has a distinct starting point. Below the initial freezing point water still may exist in the liquid state, while water elsewhere has crystallised



In the past four years we have drilled

# 89,000 km

That's more than **twice** around the world.

**Who are we?**  
 We are the world's largest oilfield services company<sup>1</sup>. Working globally—often in remote and challenging locations—we invent, design, engineer, and apply technology to help our customers find and produce oil and gas safely.

**Who are we looking for?**  
 Every year, we need thousands of graduates to begin dynamic careers in the following domains:

- Engineering, Research and Operations
- Geoscience and Petrotechnical
- Commercial and Business

**What will you be?**



<sup>1</sup>Based on Fortune 500 ranking 2011. Copyright © 2015 Schlumberger. All rights reserved.

## Schlumberger



At the initial freezing temperature there is a noticeable temperature plateau at the centre and mass average positions, while the absolute magnitude of the slope of the surface (edge) temperature is significantly less than for the slope above the initial freezing temperature. These effects are due to the release of latent heat (or, more properly, enthalpy of fusion) as the ice crystals form.

The latent heat effects accompanying the formation of ice in a food product complicate the heat transfer analysis when compared to a chilling process; nevertheless a similar empirical approach to the one outlined in Section 6.1 may be employed. There are many freezing models within the literature, most of which have been based on Plank's method from the early 20<sup>th</sup> Century; however, several studies have recommended that Pham's method provides the greatest accuracy for a range of shapes and hence will be outlined here. The freezing time ( $t_f$ ) may be calculated from:

$$t_f = \frac{L}{E_f h} \left( \frac{\Delta H_1}{\Delta T_1} + \frac{\Delta H_2}{\Delta T_2} \right) \left( 1 + \frac{Bi}{2} \right) \quad (6.19)$$

where  $E_f$  is the equivalent heat transfer dimensionality for freezing, which has values of 1, 2 and 3 for the plane wall, long cylinder and sphere respectively. Note that the plane wall and sphere represent the lower and upper limits respectively (can you see why?), and any irregular shape should have an  $E$  value between 1 and 3.  $\Delta H_1$  and  $\Delta T_1$  represent the contributions from the sensible heat above freezing, given by Eq. 6.20 and 6.21 respectively and  $\Delta H_2$  and  $\Delta T_2$  represent the latent heat contributions, given by Eq. 6.22 and 6.23:

$$\Delta H_1 = \rho_u C_{p,u} (T_i - T_{fm}) \quad (6.20)$$

$$\Delta T_1 = \frac{T_i - T_{fm}}{2} - T_\infty \quad (6.21)$$

$$\Delta H_2 = \rho_f [\Delta H_f + C_{p,f} (T_{fm} - T_c)] \quad (6.22)$$

$$\Delta T_2 = T_{fm} - T_\infty \quad (6.23)$$

The subscript  $u$  refers to the properties of the unfrozen product and  $T_{fm}$  is essentially the mid-point of the freezing process, and may be estimated by:

$$T_{fm} = 1.8 + 0.263T_c + 0.105T_\infty \quad (6.24)$$

Where  $T_c$  is the final temperature of the product, and  $T_\infty$  is the temperature of the cooling medium. For irregularly shaped objects  $E_f$  may be estimated by:

$$E_f = 1 + \frac{1 + 2/Bi}{P_1^2 + \frac{2P_1}{Bi}} + \frac{1 + 2/Bi}{P_2^2 + \frac{2P_2}{Bi}} \quad (6.25)$$

where  $P_1$  and  $P_2$  were defined by Eqs. (6.9) and (6.10).

It is worth noting that thawing is not simply the reverse process of freezing since the formation of ice crystals often has an irreversible effect on the food's structure. Cleland et al. developed a simple, semi-empirical method for predicting thawing times:

$$t_t = \frac{L\Delta H_{10}(\xi_1 + \xi_2 Bi)}{E_f h(T_\infty - T_f)} \quad (6.26)$$

where:

$$\xi_1 = 0.7754 + 2.2828\xi_3\xi_4 \quad (6.27)$$

$$\xi_2 = 0.5(0.4271 + 2.1220\xi_3 - 1.4847\xi_3^2) \quad (6.28)$$

$$\xi_3 = \rho_u C_{p,u}(T_\infty - T_f) / \Delta H_{10} \quad (6.29)$$

$$\xi_4 = \rho_f C_{p,f}(T_f - T_i) / \Delta H_{10} \quad (6.30)$$

and  $\Delta H_{10}$  is the volumetric enthalpy change of the product between 0 and  $-10^\circ\text{C}$  (which is significant, because it is the temperature range during which the fraction of ice in the food changes most rapidly).

The average heat load for a freezing process may be determined by the total heat load divided by the freezing time:

$$\dot{Q}_f = \frac{V}{t_f}(\Delta H_1 + \Delta H_2) \quad (6.31)$$

Where  $\Delta H_1$  and  $\Delta H_2$  were defined by Eqs. 6.20 and 6.22. Methods for estimating time-variable heat loads during freezing may be found in the ASHRAE Handbook of Refrigeration.

**Example 6.2:** The frozen contents of a carton of lean beef cuts,  $400 \text{ mm} \times 600 \text{ mm} \times 120 \text{ mm}$  is thawed in still air. The uniform, initial temperature of the beef is  $-40^\circ\text{C}$  and the thawing air is at  $10^\circ\text{C}$ , while the heat transfer coefficient is  $15 \text{ W m}^{-2} \text{ K}^{-1}$ . Calculate the time required for the mass average temperature of the block to reach  $5^\circ\text{C}$ .

**Solution:** Obtaining data from the ASHRAE Handbook of Refrigeration, we have:  $\rho_u = 1075 \text{ kg m}^{-3}$ ,  $\rho_f = 1018 \text{ kg m}^{-3}$ ,  $C_{p,u} = 3520 \text{ J kg}^{-1} \text{ K}^{-1}$ ,  $C_{p,f} = 2110 \text{ J kg}^{-1} \text{ K}^{-1}$ ;  $k_u = 0.49 \text{ W m}^{-1} \text{ K}^{-1}$ ,  $k_f = 1.6 \text{ W m}^{-1} \text{ K}^{-1}$ ,  $T_f = -2^\circ\text{C}$ ,  $\Delta H_{10} = 210 \text{ MJ m}^{-3}$ .

Next we calculate  $Bi$ . The shortest distance between the centre and the surface is  $60 \text{ mm}$  (i.e. half the smallest of the three dimensions of the block). The thermal conductivity of the beef is quite different depending on its state; however, we will chose the frozen beef thermal conductivity, since the majority of the warming process occurs while there is at least some ice. Hence:

$$Bi = \frac{hL}{k} = \frac{15 \times 0.06}{1.6} = 0.5625$$

In order to calculate the equivalent heat transfer dimensionality, we need to determine the parameters  $S_1$ ,  $S_2$ ,  $P_1$  and  $P_2$  in the same manner that we did in Example 6.1. For a rectangular parallelepiped (i.e. a 'brick' or 'block' shape) the areas  $S_1$  and  $S_2$  are easy to calculate:  $S_1 = 0.12 \times 0.4 = 0.024 \text{ m}^2$ , and  $S_2 = 0.12 \times 0.6 = 0.048 \text{ m}^2$ . Hence:

$$P_1 = \frac{S_1}{\pi L^2} = \frac{0.048}{\pi \times 0.06^2} = 4.24$$

$$P_2 = \frac{S_2}{\pi L^2} = \frac{0.072}{\pi \times 0.06^2} = 6.37$$

We can now use Eq. 6.25 to determine  $E_f$ :

$$E_f = 1 + \frac{1 + 2/Bi}{P_1^2 + \frac{2P_1}{Bi}} + \frac{1 + 2/Bi}{P_2^2 + \frac{2P_2}{Bi}} = 1 + \frac{1 + 2/0.5625}{4.24^2 + \frac{2 \times 4.24}{0.5625}} + \frac{1 + 2/0.5625}{6.37^2 + \frac{2 \times 6.37}{0.5625}} = 1.21$$

## American online LIGS University

is currently enrolling in the  
Interactive Online **BBA, MBA, MSc,**  
**DBA and PhD** programs:

- ▶ enroll **by September 30th, 2014** and
- ▶ **save up to 16%** on the tuition!
- ▶ pay in 10 installments / 2 years
- ▶ Interactive **Online** education
- ▶ visit [www.ligsuniversity.com](http://www.ligsuniversity.com) to  
find out more!

Note: LIGS University is not accredited by any nationally recognized accrediting agency listed by the US Secretary of Education. More info [here](#).



Click on the ad to read more

Next we calculate  $\xi_3$  and  $\xi_4$  from Eqs. 6.29 and 6.30:

$$\xi_3 = \rho_u C_{p,u} (T_\infty - T_f) / \Delta H_{10} = \frac{1075 \times 3520 \times (10 - (-2))}{2.1 \times 10^8} = 0.216$$

$$\xi_4 = \rho_f C_{p,f} (T_f - T_i) / \Delta H_{10} = \frac{1018 \times 2110 \times (-2 - (-40))}{2.1 \times 10^8} = 0.389$$

From which we can calculate  $\xi_1$  and  $\xi_2$  from Eqs. 6.27 and 6.28:

$$\xi_1 = 0.7754 + 2.2828 \xi_3 \xi_4 = 0.967$$

$$\xi_2 = 0.5(0.4271 + 2.1220 \xi_3 - 1.4847 \xi_3^2) = 0.407$$

Finally we calculate  $t_f$  from Eq. 6.26:

$$\begin{aligned} t_i &= \frac{L \Delta H_{10} (\xi_1 + \xi_2 Bi)}{E_f h (T_\infty - T_f)} = \frac{0.06 \times 2.1 \times 10^8 \times (0.967 + 0.407 \times 0.5625)}{1.21 \times 15 \times (10 - (-2))} \\ &= 69.2 \times 10^3 \text{ s} \approx 19 \text{ hours} \end{aligned}$$

## 6.4 Summary of Chapter 6

In order to design suitable refrigerated facilities, one needs to know the chilling or freezing times of the product; this will then allow for the calculation of heat loads, and finally will allow the necessary refrigeration capacity to be determined. As first approximations, relatively simple, semi-empirical calculation procedures may be employed, provided the necessary input data (e.g. thermal properties, heat transfer coefficients, initial, target, and cooling medium temperatures) are available. For greater accuracy, numerical methods may be employed, and commercial software packages especially for this purpose have been developed.

## 6.5 Further Reading

*ASHRAE Handbook: Refrigeration*, American Society of Heating, Refrigeration and Air Conditioning Engineers, Atlanta, 2010

Hayakawa, K, Villalobos, G, Formulas for estimating Smith et al. parameters to determine the mass average temperature of irregularly shaped bodies, *Journal of Food Process Engineering*, 11, 237–256, 1989

Rahman, MS, *Food Properties Handbook 2<sup>nd</sup> Ed.*, CRC Press, Boca Raton, Florida, 2009

Pham, QT, Cooling/Freezing/Thawing Time and Heat Load, in: Sun, D-W, *Advances in Food Refrigeration*, Leatherhead Publishing, Surrey, 2001

Pham, QT, Trujillo FJ, Davey, LM, McPhail, N, Cooling curves for the preliminary design of beef chillers, *International Journal of Refrigeration*, 32. 1944–1953, 2009

# 7 Food Refrigeration

Most people probably associate the term 'refrigeration' with the domestic refrigerator, which is reliable and simple to use, and is bought as a single unit containing both the chiller and the freezer. Industrially and commercially the situation is quite different. Not only will chillers and freezers often be entirely separate units, but the components of a refrigerator (compressor, condenser, expansion device and evaporator) will not necessarily be purchased at the same time, or necessarily from the same supplier. A single compressor may service multiple evaporators in different refrigerated environments; or alternatively multiple compressors may be required for a single chiller or freezer, if it has a large heat load. In fact, for a large refrigerated facility such as may be found at abattoirs there may be a number of compressors, condensers, expansions and evaporators all connected in a network, so that varying cooling capacity may be applied to different rooms as required.

On the industrial scale it is convenient to separate refrigeration applications into four categories: cooling a product to above its initial freezing temperature is known as 'chilling'; maintaining it at temperatures above the initial freezing point, is known as 'cool storage'; cooling a product below its initial freezing temperature is known as 'freezing'; maintaining its temperature below its initial freezing temperature is known as 'cold storage'. While these definitions are not always used, they are useful to bear in mind. In this chapter, 'refrigerated environment' is used as a general term to cover all four of these classes.

## 7.1 The Domestic Refrigerator

Every reader of this book will be familiar with the ubiquitous domestic refrigerator. Modern 'fridges' are simple to use, durable and reliable. The most widely used model is the upright fridge/freezer, although units which only serve as 'fridges' or only as freezers are also common. The domestic fridge is almost invariably based on the vapour compression cycle; however, for a fridge/freezer unit the basic design is slightly different to the standard vapour compression cycle illustrated schematically in Figure 2.7c. This is because in order for the two compartments to be maintained at different temperatures (the fridge compartment typically at 4 °C and the freezer compartment typically at -18 °C), the expansion process needs to be separated into two stages. However, since typically only a single compressor is employed, the energy savings of multi-stage compression (as described in Chapter 2) are not possible. A schematic of the domestic refrigerator components is shown in Figure 7.1a with the corresponding PH diagram in Figure 7.1b.

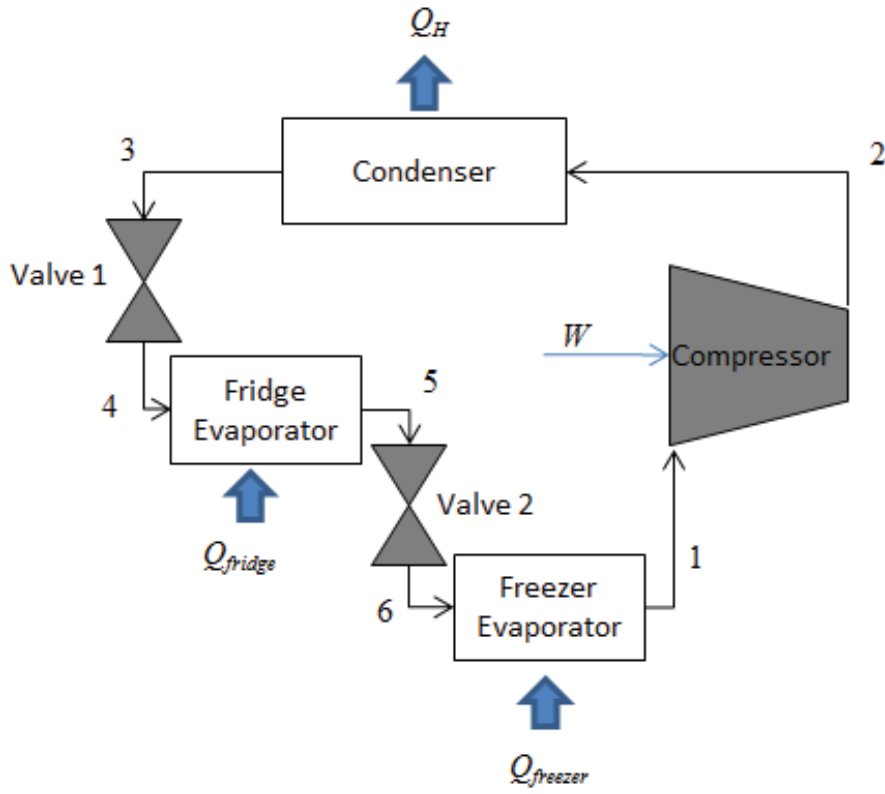

Figure 7.1a: Schematic of the essential components of the domestic fridge/freezer

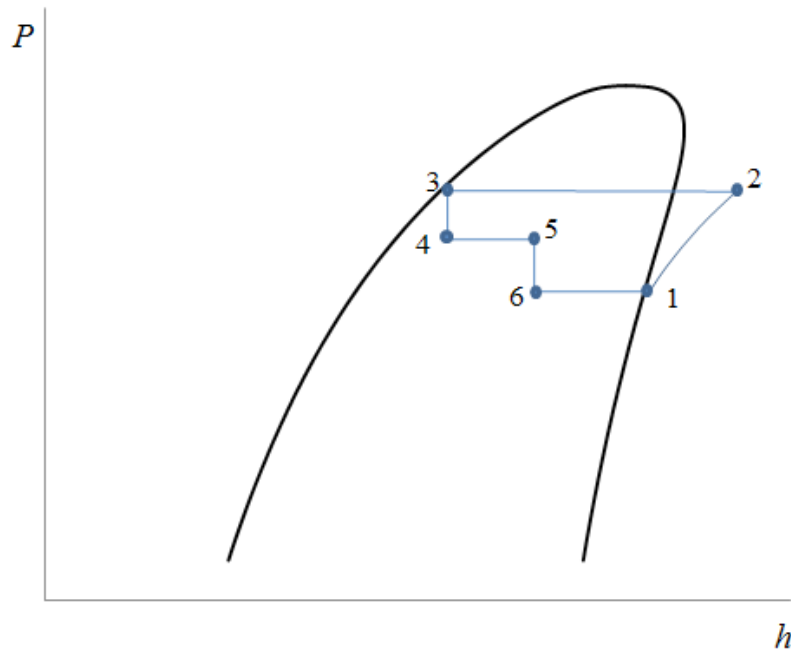

Figure 7.1b: PH diagram for an ideal domestic fridge/freezer cycle



Figure 7.1a shows the refrigerant passing through the fridge evaporator and freezer evaporator in series – an alternative, parallel arrangement is also possible. Note that the expansion valve is sometimes called a ‘metering device’ since it can be used to control the flow of refrigerant (although its essential function is to reduce the pressure of the refrigerant). With variable-speed compressors which may be used to control the flow of refrigerant becoming more common, many modern domestic refrigerators achieve the expansion simply by crimping a restriction (throttle) into the refrigerant line – with no actual valve required.

### 7.2 The Cold Chain

Most food will go through several different stages of chilling/freezing and cool/cold storage between the time it is harvested and the time it is consumed. To illustrate just how significant a role refrigeration plays in keeping us fed, consider frozen beef being exported from New Zealand to Europe. Immediately after it has been slaughtered and ‘dressed’ (i.e. had the head, hide, offal, tail etc. removed) a side of beef will be placed in a carcass chiller for a period of more than 24 hours. Following the chilling process it will be separated into different cuts in a ‘boning room’ maintained at about 10 °C and packed into cartons. These cartons will then be placed in a blast freezer before being stored frozen, until they are ready to be transported. When they are ready to be transported they will probably be loaded into refrigerated (‘reefer’) containers and placed on either a road or rail truck and taken to a seaport. At the port they will be loaded onto a ship which will sail to Europe, a journey that will take several weeks to complete. After being unloaded at the destination port, the beef will most likely be taken to a cold storage facility at the retailer’s warehouse. At some point the meat will be placed in a refrigerated retail display cabinet (e.g. at a supermarket) for sale. Once purchased, it will most likely spend some time in the customer’s domestic refrigerator.

.....Alcatel-Lucent 

[www.alcatel-lucent.com/careers](http://www.alcatel-lucent.com/careers)

What if you could build your future and create the future?

One generation’s transformation is the next’s status quo. In the near future, people may soon think it’s strange that devices ever had to be “plugged in.” To obtain that status, there needs to be “The Shift”.

 [Click on the ad to read more](#)

The journey of the beef from the abattoir to the customer's home is referred to as the *Cold Chain*, since refrigeration plays such an important role at every stage of its journey. Some countries are net importers of food, meaning they rely on food from other countries to keep their population fed (e.g. Lebanon imports more than 80% of its food!). A robust, effective Cold Chain is obviously vital for feeding the ever-increasing global population. This means that at each stage (each 'link' in the 'chain') the product's 'temperature integrity' must be maintained (i.e. its temperature must be held between certain limits).

Failure in the cold chain is often due to poor handling and logistics, and can be responsible for loss of product during transportation, rejection of the product by the customer or retailer, or else food poisoning if it is unhygienic when consumed.

### 7.3 Typical examples of refrigerated facilities

Figure 7.2 shows a schematic of a typical, multi-purpose freezing facility. The facility is divided into cold stores accessed by a central air-lock passageway. The stores may each be maintained at different temperatures, while the air-lock will typically be the closest to ambient in temperature. For large facilities the stores will be accessible by forklift, and in some cases small trucks. Often a truck will be able to enter the air-lock at least, in order that it may be loaded under cool conditions.

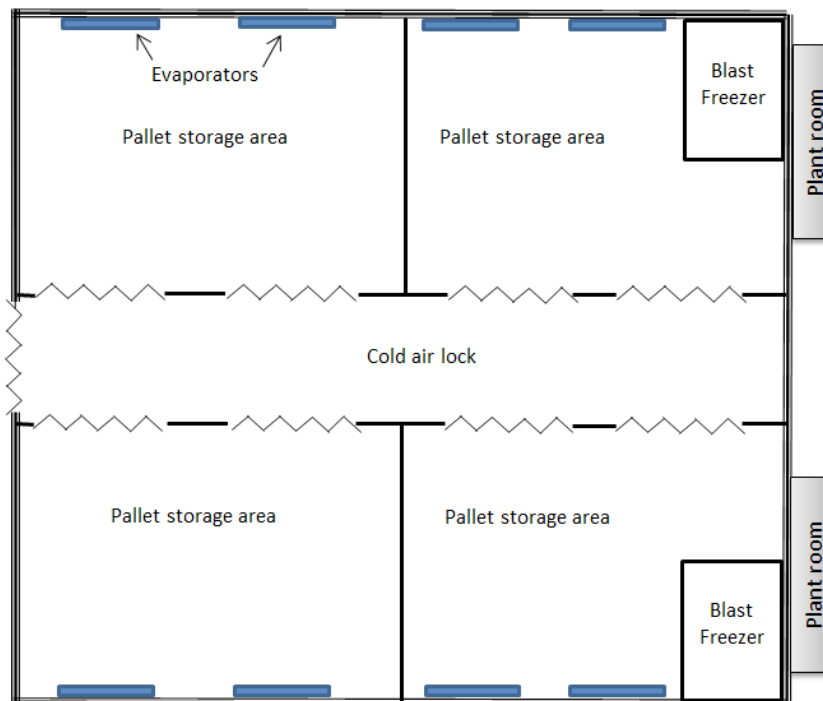

**Figure 7.2:** Schematic of a cold-store, including blast freezers

The access-ways in the facility need to be designed to minimize heat and moisture ingress to the stores. This may be achieved in a number of ways, but the most common ones include roller doors, strip curtains, and air curtains (i.e. jets of air that are sent down from vents above the doorways to provide positive pressure against the air within the store) or a combination of these. If no significant traffic into or out of a store is expected for significant periods, then a properly insulated door will be pulled across the access-way to achieve a near air-tight seal.

In one corner of two of the stores in Figure 7.2 is an air blast freezer. A schematic of a blast-freezer is shown in Figure 7.3.

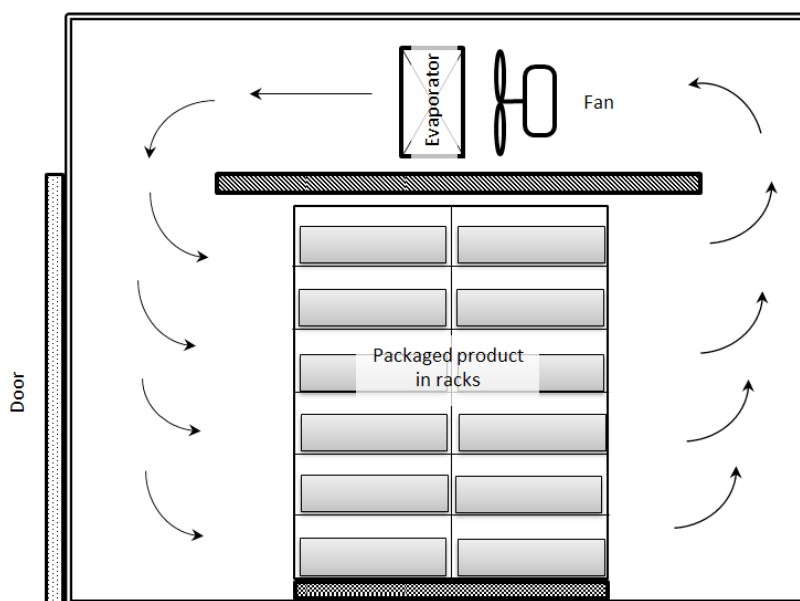

**Figure 7.3:** Schematic of a blast freezer

Product, which typically has been pre-packaged, is placed onto racks which allow space for air-flow between the product boxes. The evaporator fans generate high velocities ( $>10 \text{ m s}^{-1}$ ) to achieve high rates of freezing. Once a batch has been frozen, it will be removed and placed in the storage area outside the blast freezer, and a new batch will be placed in the blast freezer.

In addition to the generic cold-store and blast-freezer complex shown in Figure 7.2, there are some more specialised refrigeration facilities. A carcass chiller (illustrated schematically in Figure 7.4) is essentially a large room with a relatively low ceiling in which whole lamb carcasses, or pork or beef sides are hung on rails. Most carcass chillers will have some type of arrangement to ensure air is distributed throughout the chiller to minimise variation in chilling rates in different regions of the room. Some modern carcass chillers even use water spray, if permitted by regulatory bodies, to increase chilling rates and minimise weight loss. Carcasses are usually cooled for several hours before either being transported for sale whole, or more commonly packaged as individual cuts, often with the removal of significant amounts of fat and bone. The rooms where the carcasses are cut (sometimes referred to as ‘boning rooms’) also need to be maintained at temperatures well-below ambient (e.g.  $10 \text{ }^\circ\text{C}$ ).

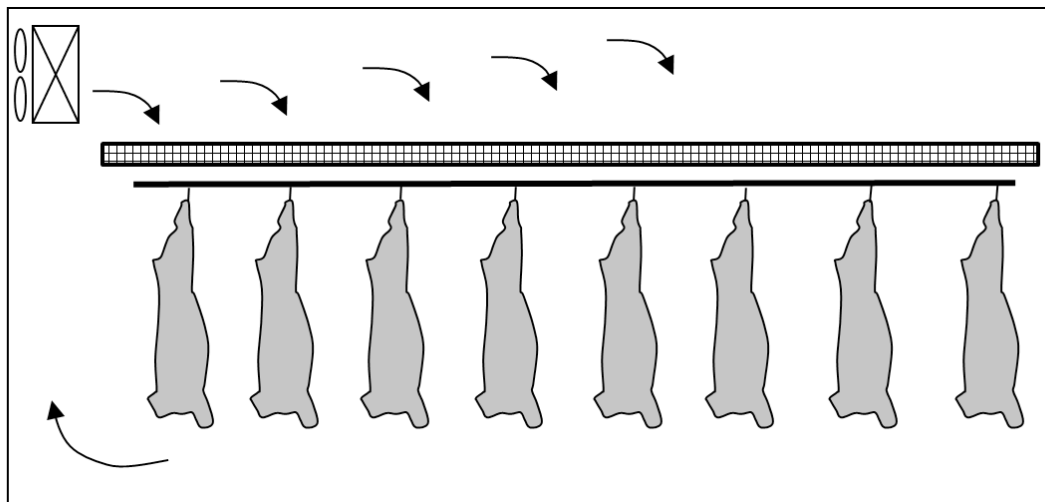

Figure 7.4: Schematic of a carcass chiller

Fruit and vegetable cool-stores are often fitted with equipment to control the composition of the gas in the room, in order to restrict the rate of ripening and/or reduce the moisture loss during storage. Controlled Atmosphere (CA) storage refers to the storage facilities in which the amounts of oxygen, nitrogen and carbon dioxide or monitored and controlled, often with oxygen levels lower than found in air. Modified Atmosphere (MA) storage (often part of the packaging) refers to environments in which the amount of oxygen is greatly reduced, or essentially removed altogether, and has been found to extend shelf-life significantly.



Join the best at  
the Maastricht University  
School of Business and  
Economics!

Top master's programmes

- 33<sup>rd</sup> place Financial Times worldwide ranking: MSc International Business
- 1<sup>st</sup> place: MSc International Business
- 1<sup>st</sup> place: MSc Financial Economics
- 2<sup>nd</sup> place: MSc Management of Learning
- 2<sup>nd</sup> place: MSc Economics
- 2<sup>nd</sup> place: MSc Econometrics and Operations Research
- 2<sup>nd</sup> place: MSc Global Supply Chain Management and Change

Sources: Keuzegids Master ranking 2013; Elsevier 'Beste Studies' ranking 2012; Financial Times Global Masters in Management ranking 2012

Maastricht University is the best specialist university in the Netherlands (Elsevier)

Visit us and find out why we are the best!  
Master's Open Day: 22 February 2014

[www.mastersopenday.nl](http://www.mastersopenday.nl)



Most fishing vessels have on-board cold-storage facilities, since they may be away from port for weeks at a time. Some species are simply packed whole in ice in insulated rooms below deck, while other species may be partially 'dressed' (e.g. have their heads, guts and tails removed) on deck before being packed into boxes, frozen in a plate-freezer, and placed in a cold-store.

## 7.4 Design Considerations

Regardless of the specific design of the chiller, freezer, cool- or cold-store, there are some general design considerations that apply.

### 7.4.1 Capacity and Temperature

Probably the first decisions that need to be made are what quantity of product is expected to be cooled/stored and at what temperature. For the chilling and freezing processes (as opposed to cool and cold storage), the initial temperature is also important. The quantity and temperatures of the product will determine the required capacity of the refrigeration (in terms of kW), using techniques similar to ones described in Chapter 6.

In addition to the heat load from the product, a number of other sources can contribute to the total heat load, depending on the type of refrigerated environment:

- Heat infiltration through walls, floor, ceiling, pillars, beams etc. (should be minimised by good insulation)
- Heat from warm, humid air coming in through doors or other access-ways (see Section 7.4.3)
- Heat from evaporator fans circulating the air in the refrigerated environment
- Heat from lights
- Heat of respiration (not only from humans present, but also from some products, fruit and vegetables in particular)
- Heat from forklift trucks or other vehicles used to transfer product in
- Heat from the defrost cycle (see Section 7.4.3)

The relative magnitudes of each component within the total heat load will vary widely between different refrigerated environments. Many of the components of the heat load may be determined using simple variations of Eq. 3.11. Once the total heat load has been estimated, and an appropriate design safety factor has been applied, the selection of the most effective compressor and refrigerant pairing ('effective' here being meant to include both energy efficiency and cost) may be made.

### 7.4.2 Air movement

The cooling medium for most refrigerated facilities is air. Typically the evaporators of the refrigeration system are located in one part of the refrigerated environment with fans being relied upon for circulating the air. One problem that can arise is that of 'short-circuiting', where cold air exiting the evaporator(s) is sucked back around to the inlet, without passing over most of the product. This will lead to relatively warm regions ('hotspots'), resulting in significantly reduced cooling times, or product not reaching the required temperature at all.

It may not be sufficient simply for air to be well-distributed in the head space above the product and in aisle spaces; significant air-flow through the product stacks may also be required in order to achieve not only the desired rate of cooling, but also uniform rates of cooling between product stacks in different parts of the refrigerated environment. In addition to the evaporator fans, which are standard, air movement can be aided by diffusers, vanes and ducting that can distribute the air optimally, at the expense of higher pressure drops needing to be overcome by the fans.

(Note that not all chillers and freezers use air, some rely on liquids such as water or an 'anti-freeze' solution, or by direct physical contact, in the case of plate freezers. However, most cool/cold stores use air).

### 7.4.3 Control of moisture

It is almost impossible to prevent moisture entering refrigerated environments where it increases the cooling load (due its latent heat of evaporation), reduces the effectiveness of the evaporator (by causing frost and/or mould build-up on the heat exchange surface) and can also be a hazard, particularly in freezers and cold stores, where ice can build up on the floor and potentially result in slips.

Moisture may enter the refrigerated environment as humidity in the air that accompanies staff and product when they enter, or from the product itself as it cools (e.g. carcass chillers and fruit stores in which the product can release significant quantities of moisture). Most chillers and cool-stores will have humidity control, since humidity is often a significant factor in determining the shelf-life of chilled products. Almost all evaporators will have some sort of defrost-mechanism, which typically involves heating the evaporator surface to melt any ice that has built-up (note that even chillers and cool-stores may have ice build-up, since the evaporator temperature may have to be below 0 °C, in order to maintain air temperatures of 0 to 4 °C). The heating of the evaporator surface may either be achieved externally, or by allowing some of the refrigerant exiting the compressor to bypass the condenser and expansion, and enter the evaporator as a hot vapour. The defrost cycle is an extra heat load, but is compensated for by the improved performance of the evaporator.

Measures are also taken to restrict the quantity of warm, humid air entering the refrigerated environment through the use of strip curtains and air curtains, and by management of the number of entries and exits to/from the refrigerated environment.

#### 7.4.4 Insulation

Effective insulation is critical for the efficiency of cool/cold stores. Ideally insulation is incorporated within the structural elements of the building when the facility is built, since this tends to result in the most durable arrangement. Spray-on, foam insulation may be used if an existing building has been converted to a cool/cold store. It is important to recognise that it is not only walls and doors that need to be insulated, but also ceilings and, for freezers and cold stores in particular, floors.

Insulation should not only provide a barrier to heat transfer, it should also be effective as a moisture barrier. This is not only to prevent moisture ingress from outside, but also to prevent moisture from within the store permeating the insulating material, which can significantly reduce its effectiveness. Particular care is needed to ensure moisture barriers are maintained at joins between walls, floors and ceilings.

Floor insulation is highly recommended for freezers and cold stores, to prevent ice forming in the soil below, which may then crack concrete floors as it expands (a phenomenon known as 'frost heave'). The alternative would be to heat the soil underneath to prevent it from freezing, but would be an added running cost, not only from the direct heating cost, but also the added heat load from infiltration through the floor to the store.



**> Apply now**

REDEFINE YOUR FUTURE  
**AXA GLOBAL GRADUATE  
PROGRAM 2015**

redefining / standards 

agence.cdg. © Photomistop

#### 7.4.5 Access-ways and traffic

Access-ways (mainly doors, but possibly hatches and windows) in cool/cold stores need to be practical in the sense that they need to be in convenient positions and large enough to allow stacks of product and its transportation (e.g. forklift trucks) to pass through. However, the larger the access-way the greater the amount of warm, moist air that can infiltrate the refrigerated environment, and if the access-way is too close to the evaporator fans, then cold air can be blown out at the same time that warm, moist air is sucked in. Strip curtains, air curtains and roller doors can help minimise these losses, but clearly optimisation is required to balance the potentially conflicting requirements of practicality and energy efficiency. Smart scheduling of the loading and unloading of refrigerated environments can also be used to minimise the number of accesses, and hence the quantities of cold air that is lost and warm, moist air that replaces it.

Cool/cold stores are often large enough to have forklift trucks driving around in them, and a storage facility may have a central air-lock (see Figure 7.2) that is large enough to contain a transportation truck, so that product can be loaded under cool conditions, out of direct sunlight. Where possible, electric vehicles should be used since they produce much less heat than petroleum-fuelled vehicles, and no moisture vapour exhaust. Electric forklifts are very common; however, the majority of transport vehicles are diesel-fuelled. Clearly, if a diesel truck is inside a store it should not be allowed to idle while it is being loaded, as often tends to be the case when trucks are loaded outside a store.

#### 7.4.6 Controlled and modified atmospheres

The design of controlled and modified atmosphere stores requires extra care and consideration, since they will need to be sealed sufficiently to prevent significant ingress and egress of gases. The number of accesses in a controlled atmosphere store should be minimal; in fact the ideal is for a batch of product to be loaded into the store, the store to be sealed, and then left until the required storage time has elapsed, at which point the entire batch is unloaded. However, this will not always be possible for logistical reasons.

### 7.5 Refrigerated transport

Refrigerated transport vehicles may be thought of as special classes of cool/cold stores (and in some cases they also do some chilling and freezing). Road trucks, rail-trucks, ships and airplanes are all in use for transporting refrigerated food. Some vehicles only have thermal insulation and rely on the thermal mass of the product to maintain temperature integrity; however, many have their own active refrigeration system. Reefer containers in particular have become popular, since they are modular and can be used with road, rail and sea transportation, simply by plugging them into a power source.



Most of the general design principles described in Section 7.4 apply to refrigerated transport; however, there are obviously extra considerations that need to be made. For example, a reefer container, which must draw its power from an external source, either mains power at a warehouse or the truck/train/ship transporting it, needs to be plugged in manually at the start of each stage of its journey – simple human error, could mean that is not. For frozen product, occasional lapses can be tolerated but for chilled product such a mistake can spoil the contents of an entire container. Hence a reefer is more likely to experience power failure than a permanent refrigerated building with hard wired power. Also, refrigeration systems on transports experience far more vibration and mechanical shock than permanent structures, and hence are more exposed to failure by wear and tear. The logistics associated with refrigerated transport is also, perhaps, a more difficult exercise than managing a cool/cold store facility since tracking the location and monitoring temperatures of the product is confined to a much smaller space.

Since there are typically a number of different parties involved in the cold chain of a particular product, it will not always be clear who is to blame if and when a failure occurs which results in the loss of product. Unsurprisingly there are frequent disputes between producer, transport companies, warehouse companies, port companies and retailers, many of which result in litigation. For this reason there has been, particularly in Developed Nations, greater efforts put into auditing the cold chain, using a variety of different methods to monitor the product's temperature over time, and preferably to identify when a failure has occurred, and therefore who is culpable.



**Empowering People. Improving Business.**

BI Norwegian Business School is one of Europe's largest business schools welcoming more than 20,000 students. Our programmes provide a stimulating and multi-cultural learning environment with an international outlook ultimately providing students with professional skills to meet the increasing needs of businesses.

BI offers four different two-year, full-time Master of Science (MSc) programmes that are taught entirely in English and have been designed to provide professional skills to meet the increasing need of businesses. The MSc programmes provide a stimulating and multi-cultural learning environment to give you the best platform to launch into your career.

- MSc in Business
- MSc in Financial Economics
- MSc in Strategic Marketing Management
- MSc in Leadership and Organisational Psychology

**BI NORWEGIAN BUSINESS SCHOOL**

EFMD  
**EQUIS**  
ACCREDITED

[www.bi.edu/master](http://www.bi.edu/master)

Food products have different optimal transportation conditions – the most significant of which is the product temperature. Tables 7.1 to 7.3 show transportation conditions recommended by the International Institute of Refrigeration, for three different classes of chilled product.

<b>Product</b>	<b>Recommended transportation temperature</b> °C	<b>Temperature range limits</b> °C	<b>Initial freezing temperature</b> °C	<b>Typical Shelf life</b> (days)
Apples	0	-0.5 to +2	-1.5	varies between species
Apricot	-0.5	-0.5 to 1	-1.5	20
Avocado	7	4.5 to 13	-0.5	
Bananas	12	12 to 13.5	-1	24
Cherry	-0.5	-1 to 0	-1.5	20
Grape	-0.5	-1 to +0.5	-1.5	50 to 100
Grapefruit	10	+4.5 to +16	-1	40
Plum	-0.5	-0.5 to +0.5	-1	20 to 35
Kiwifruit	-0.5	-0.5 to +0.6	-2	50 to 75
Lemon	10	+5 to +16	-1.5	80
Mango	10	9 to 12		
Nectarine	-0.5	-0.5 to +0.5	-1	
Orange	4.5	+3 to +7	-1	40 to 50
Papaya	7	4 to 12	-1	14 to 21
Peach	-0.5	-0.5 to +1	-1.5	30
Pear	-0.5	-1 to +0.5	-1.5	60 to 150
Pineapple	8.5	+7 to +10	-1	30
Watermelon	10	4.5 to 10		

**Table 7.1:** Recommended transportation conditions for selected fruits

Product	Recommended transportation temperature °C	Temperature range limits °C	Initial freezing temperature °C	Typical Shelf life (days)
Asparagus	0	0 to 1	-0.5	20
Aubergine	7	7 to 10	-0.5	14
Beans (French)	0	0 to 7	-0.5	20
Beetroot	0	0 to 1	-0.5	60 to 90
Broccoli	0	0 to 1	-0.5	10
Brussels sprouts	0	0 to 1	-0.5	30
Cabbage	0	0 to 1	-0.5	20
Carrots	0	-0.5 to 0.5	-0.5	70
Cauliflower	0	0 to 1	-0.5	30
Celery	0	0 to 1	-0.3	60 to 90
Endive	0	0 to 1	-0.5	14 to 20
Cucumber	7	7 to 10	-0.3	14
Garlic	0	0 to 1	-0.5	150
Ginger	12	10 to 13		150
Leeks	0	0 to 1	-0.5	60
Lettuce (iceberg)	0	0 to 1	-0.5	40
Onions	0	0 to 1	-0.5	30 to 120
Peas (in pod)	0	0 to 1	-0.5	7 to 20
Peppers	7	7 to 10	-0.5	20
Potatoes	7	4.5 to 10	-0.5	60 to 150
Pumpkin	10	10 to 13	-0.5	60 to 90
Rhubarb	0	0 to 1	-0.5	15 to 30
Sweet potato	13	13 to 16	-1	120
Tomato (green)	13	10 to 16	-0.5	20

**Table 7.2:** Recommended transportation conditions for selected vegetables

Product	Recommended transportation temperature °C	Temperature range limits °C	Initial freezing temperature °C	Typical Shelf life (days)
Bacon	-1	-2 to 4		
Beef (chilled, quarters)	-1.5	-0.5 to 1	-1.7	20
Beef (chilled, packed)	-1.5	-0.5 to 2	-1.7	70
Butter	0	-1 to 4.5		30
Cheese	2	0 to 10	varies with variety	
Cream	0	-1 to 0.5	-2.2	10
Eggs	0	-1 to 0.6	-0.6	180
Seafood	-0.5	-2 to 4.4	-2.2	14 to 20
Venison	0	-1.5 to 0		14
Ham	-0.5	-1.5 to 0.5		21
Lamb (chilled, whole)	-1.5	-1.5 to 0	-1.9	30
Lamb (chilled, packed)	-1.5	-1.5 to 1	-1.9	70
Lard	0	-1.5 to 4.5		180
Margarine	0	-1.5 to 0.5		180
Milk (pasteurised)	0	-0.5 to 1	-0.6	14
Pork (unsalted)	-1.5	-1.5 to 0	-2.2	14
Pork (salted)	4.5	-1 to 7		120
Poultry	-1	-1.5 to 1.5	-2.8	14

**Table 7.3:** Recommended transportation conditions for selected protein foods

## 7.6 Summary of Chapter 7

The 'Cold Chain' is the term given to the various refrigeration stages that a food (or pharmaceutical) product experiences between harvest/production and consumption. The term 'chain' is appropriate since the food may be spoiled by lack of temperature integrity ('failure') at any stage ('link') in the chain. Careful design and operation of refrigerated environments and good logistical management are required in order to maintain temperature integrity throughout the chain, thereby satisfying producer, retailer and customer, and, more importantly, allowing for a steady supply of food year round.

## 7.7 Further Reading

*ASHRAE Handbook: Refrigeration*, American Society of Heating, Refrigeration and Air Conditioning Engineers, Atlanta, 2010

Heap, R (Ed.), *Guide to Refrigerated Transport 2<sup>nd</sup> Edition*, International Institute of Refrigeration, Paris, 2010

Hundy, GF, Trott, AR & Welch, TC, *Refrigeration and Air Conditioning*, 4<sup>th</sup> Ed., Butterworth Heinemann, Oxford, 2008

Pham, QT, Trujillo FJ, Davey, LM, McPhail, N, Cooling curves for the preliminary design of beef chillers, *International Journal of Refrigeration*, 32. 1944–1953, 2009

Rahman, MS, *Food Properties Handbook 2<sup>nd</sup> Ed.*, CRC Press, Boca Raton, Florida, 2009

## Need help with your dissertation?

Get in-depth feedback & advice from experts in your topic area. Find out what you can do to improve the quality of your dissertation!

Get Help Now



Go to [www.helpmyassignment.co.uk](http://www.helpmyassignment.co.uk) for more info



**Helpmyassignment**



# 8 Air Conditioning

'Air conditioning' is the term used to describe the supply of comfortable, healthy air to the interior of building. Often this requires the air to be cooled (i.e. refrigeration), but humidity regulation, air movement (ventilation), and dust and odour removal are also important. Comfortable room temperatures tend to be in the range of 19 °C to 25 °C, comfortable humidity levels tend to be in the range of 60 to 80% (at comfortable room temperatures), and air movement up to 0.25 m s<sup>-1</sup> for ventilation is considered comfortable. However, since this is a book about refrigeration, this chapter will focus briefly on the refrigeration aspect of air conditioning.

## 8.1 Air-conditioning Cooling Load Calculations

Air-conditioning for human comfort has slightly different aims compared to food refrigeration, in that we are not trying to reduce the core temperature of the human body. Instead we are concerned with removing the heat generated by the human body, by lighting and appliances that give off heat as a waste product, and also to cool fresh air from outside for ventilation purposes. For this reason, steady-state models similar to the ones discussed in Chapter 3 would be sufficient for estimating cooling loads.

### 8.1.1 Heat load categories

Heat loads for air-conditioning can come from a variety of sources, which may be divided into two categories: internal heat loads and external heat loads.

**Internal heat loads** include:

- Humans – a person involved in normal indoor activity will produce between 100 and 600 W depending on their age, size and specific activity (see Table 8.1). Hence a room filled with a large number of people can be a significant heat load, measuring in the region of several kilowatts.
- Lighting – each light gives of a certain wattage and individual bulbs can be in the range of 100 W.
- Appliances/machines – large televisions, domestic refrigerators, washing machines, computers all give off heat while in use. Any appliance that uses electricity will produce heat as a waste product.

**External heat loads** include:

- Solar loads – the biggest solar gain is by sunlight shining through transparent surfaces such as windows. Sunlight heating walls and roofs can also add significantly to the heat load on a room, particularly if there is little thermal cladding. Estimating solar loads accurately is more complex than for internal gains, however, several sources (including those listed at the end of the chapter) provide relatively simple guides
- Hot winds – although typically much less of a factor than solar loads can be significant if there is poor thermal cladding on the building. Of course strong winds which are lower in temperature than the external surface temperature of the building will actually reduce heat loads

Activity	Heat Load W
Sleeping	70
Seated, still	100
Standing	150
Walking at 3 km/h	300
Office work	150
Retail work	180
Industrial	300–600

**Table 8.1:** Typical values of heat produced by human activity (adapted from Stoecker and Jones)

### 8.1.2 Air conditioning heat load estimation procedure

The following procedure is adapted from the recommendations of Stoecker and Jones (listed at the end of the chapter):

1. Determine the design-basis external air temperature and humidity (i.e. the climate in the geographical region where the building is located). Typically this means using a conservative value, i.e. for cooling, the design might be based on the 98<sup>th</sup> percentile temperature (i.e. the value which the actual temperature is lower than for 98% of the time)
2. Select the desired air temperature and humidity within the building (e.g. 22 °C, 60 % humidity)
3. For each room being considered estimate the temperature in any adjacent rooms
4. Estimate the overall heat transfer coefficients ( $U$ ) within each room
5. Estimate the rate of infiltration of air (including active ventilation) into the room
6. Determine the latitude, orientation, external shading that will affect solar heat-load calculations
7. Determine the thermal properties of the building and insulation materials and the heat transfer coefficients within the rooms

8. Calculate the rate of heat gain into the room from external sources
9. Estimate the maximum number of people likely to be within each room, and their most active occupation
10. Determine the amount of lighting and the power consumption of appliances/machines that will be within each room
11. Sum the internal and external heat loads to estimate the required cooling capacity

Many of the steps above require location-specific and material specific data. Sources such as the *ASHRAE Handbook of Fundamentals*, contain much of this required data, particularly for buildings located within the United States. Once the required input data have been obtained most of the individual calculation steps are relatively straightforward (often being simple variations of Eq. 3.11), provided the procedures are followed correctly. The following example illustrates the types of calculation involved.

**Example 8.1:** Estimate the internal heat generation that could be expected for an office which will be occupied by 4 to 8 people, four lap-top computers, a small fridge and 10 fluorescent tube lights in the ceiling.



**Brain power**

By 2020, wind could provide one-tenth of our planet's electricity needs. Already today, SKF's innovative know-how is crucial to running a large proportion of the world's wind turbines.

Up to 25 % of the generating costs relate to maintenance. These can be reduced dramatically thanks to our systems for on-line condition monitoring and automatic lubrication. We help make it more economical to create cleaner, cheaper energy out of thin air.

By sharing our experience, expertise, and creativity, industries can boost performance beyond expectations. Therefore we need the best employees who can meet this challenge!

The Power of Knowledge Engineering

Plug into The Power of Knowledge Engineering.  
Visit us at [www.skf.com/knowledge](http://www.skf.com/knowledge)

**SKF**



**Solution:** Indicative values for the power consumption of appliances are relatively simple to obtain, and is often indicated on the appliance itself (or from manufacturer's data on the internet). A small fridge will draw about 200 W, while lap-top computers might draw 50 W each. Each tube light may be assumed to draw 30 W (including the ballast).

Since up to eight people may be expected to occupy the office we should use that number along with the data in Table 8.1 to estimate the heat load. Hence:

$$\dot{Q}_{\text{appliances}} = 1 \times 200 + 4 \times 50 = 400 \text{ W}$$

$$\dot{Q}_{\text{lighting}} = 10 \times 30 = 300 \text{ W}$$

$$\dot{Q}_{\text{occupants}} = 8 \times 150 = 1200 \text{ W}$$

$$\therefore \dot{Q}_{\text{total}} = \dot{Q}_{\text{appliances}} + \dot{Q}_{\text{lighting}} + \dot{Q}_{\text{occupants}} = 1900 \text{ W}$$

Note that in this example the largest internal heat load is from the occupants. The final value would be more meaningful if it could also be expressed on a per unit volume (of the room) basis, or at least on a per floor-area basis, since that will give an idea of the load density, as well as the total load.

## 8.2 Domestic air-conditioning

Once the design conditions and cooling load have been determined, an appropriate air-conditioner may be selected. For most domestic applications, air-conditioners are based on the vapour-compression cycle, although evaporative coolers are popular in hot, dry climates (see Chapter 5). The operation principle of the air-conditioner is identical to that of the food refrigerator, as outlined in Chapter 2, with the same four essential components (namely the compressor, condenser, expander and evaporator). The main difference between the air-conditioner and food refrigerator is in its mechanical design (obviously, it does not have an enclosed product space). Even for a domestic unit, it may not be a single physically contiguous unit (by contrast with the domestic refrigerator).

Perhaps the most common design option in current use in a number of countries outside the tropics is the split, invertible heat pump, which is illustrated schematically in Figure 8.1.

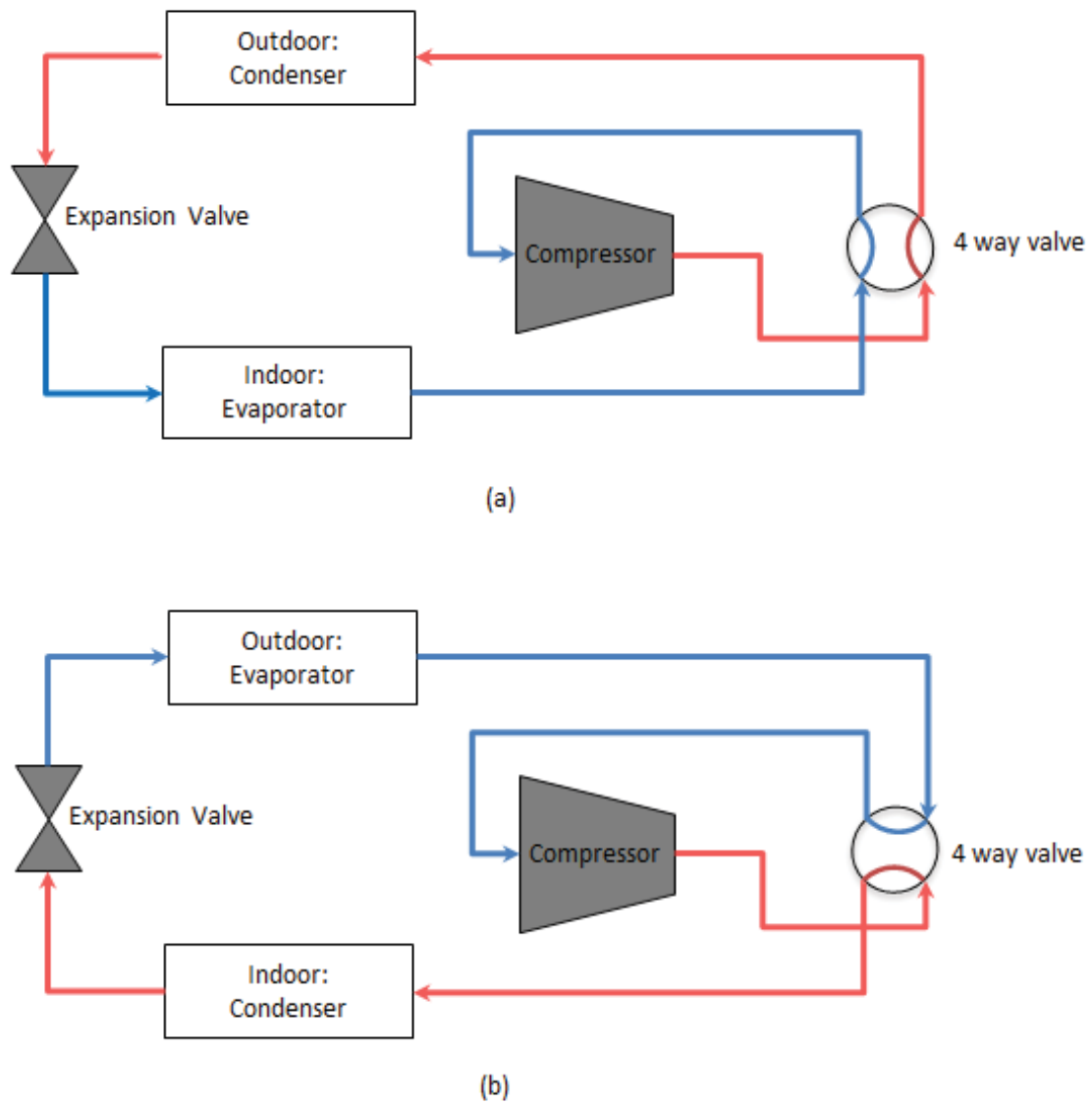

**Figure 8.1:** Invertible domestic heat pump/air conditioner; a) air-conditioning (cooling) configuration, b) heat pumping (heating) configuration

A simple 4-way valve is employed to convert the heat pump (in which the heat exchanger inside the home is the high temperature condenser) into an air conditioner (in which the heat exchanger inside is the low-temperature evaporator).

### 8.3 Large-scale air-conditioning

Simple 'package' heat pump/air conditioners may be most practical and economical for the domestic setting, but for larger scales a more integrated approach will often be more effective (although large buildings sometimes have numerous individual domestic-scale air conditioners). In a large building there may be several heat sources and several heat sinks. In this case individual heat pumps can be combined in a network which also contains Air Handling Units (AHUs). Water is often used as a secondary refrigerant to transport heat away from one space to another.

In recent times data centres (i.e. rooms that house file servers and other computing equipment) have become a special air-conditioning application. The heat generation density (i.e. watts generated per square metre of floor area) can be significantly higher than for a room occupied mainly by people. In cold climates, large volumetric flow-rates of air may be sufficient to keep the centre at the required temperature; however, water will need to be used as a medium for carrying the heat, due to the high heat generation density. Where possible evaporative cooling will be employed, but if the long-term wet-bulb temperature of the ambient air is not sufficiently low (i.e. warm, humid climates) then air conditioning, or refrigeration of the cooling water will be required.



What do you want to do?

No matter what you want out of your future career, an employer with a broad range of operations in a load of countries will always be the ticket. Working within the Volvo Group means more than 100,000 friends and colleagues in more than 185 countries all over the world. We offer graduates great career opportunities – check out the Career section at our web site [www.volvogroup.com](http://www.volvogroup.com). We look forward to getting to know you!

**VOLVO**  
AB Volvo (publ)  
[www.volvogroup.com](http://www.volvogroup.com)

VOLVO TRUCKS | RENAULT TRUCKS | MACK TRUCKS | VOLVO BUSES | VOLVO CONSTRUCTION EQUIPMENT | VOLVO PENTA | VOLVO AERO | VOLVO IT  
VOLVO FINANCIAL SERVICES | VOLVO 3P | VOLVO POWERTRAIN | VOLVO PARTS | VOLVO TECHNOLOGY | VOLVO LOGISTICS | BUSINESS AREA ASIA

## 8.4 Summary of Chapter 8

'Air conditioning' refers to the process of achieving and maintaining air within certain constraints of temperature, humidity, and freshness. From a temperature management perspective, it is an identical process to refrigeration, usually employing the vapour-compression cycle (with the notable exception of evaporative coolers in hot, dry climates). Many air conditioners can be used to provide both cooling and heating (heat pumping) by redirecting the flow of refrigerant within the system.

## 8.5 Further Reading

*ASHRAE Handbook: Refrigeration*, American Society of Heating, Refrigeration and Air Conditioning Engineers, Atlanta, 2010

*ASHRAE Handbook: Fundamentals*, American Society of Heating, Refrigeration and Air Conditioning Engineers, Atlanta, 2009

Çengel, YA & Boles, MA, *Thermodynamics: An Engineering Approach*, 7<sup>th</sup> Ed., McGraw Hill, New York, 2011

Çengel, YA & Ghajar, AJ, *Heat and Mass Transfer: fundamentals and applications*, 4<sup>th</sup> Ed., McGraw Hill, New York, 2011

Hundy, GF, Trott, AR & Welch, TC, *Refrigeration and Air Conditioning*, 4<sup>th</sup> Ed., Butterworth Heinemann, Oxford, 2008

Stoecker, WF & Jones, JW, *Refrigeration and Air Conditioning*, 2<sup>nd</sup> Ed., McGraw Hill, New York, 1986

Rahman, MS, *Food Properties Handbook 2<sup>nd</sup> Ed.*, CRC Press, Boca Raton, Florida, 2009

# 9 Cryogenics and Gas Liquefaction

## 9.1 Cryogenics

The term 'cryogenic' refers to low temperatures, and while there is no universally agreed upon threshold defining the start of the cryogenic temperature range, it is in the vicinity of  $-100\text{ }^{\circ}\text{C}$  to  $-150\text{ }^{\circ}\text{C}$ . Cryogenics finds applications in the following fields:

- Transportation of natural gas
- Electricity transmission (the lower the temperature the lower the transmission losses)
- Superconductivity research and modern physics (e.g. in CERN's Large Hadron Collider)
- Cryo-surgery
- MRI and other analytical tools
- Rocket propulsion (liquid hydrogen as the fuel, liquid oxygen as the oxidiser)
- Long-term storage of biological media (e.g. blood and sperm)
- Industrial applications

The search for the lowest achievable temperature is a field of research in itself, as workers strive to get closer and closer to absolute zero.

Cryogenic refrigeration is most commonly achieved by allowing a liquefied gas to evaporate to the atmosphere. This is a very simple method of maintaining a steady, low temperature. Table 9.1 shows the normal boiling points (i.e. boiling points at atmospheric pressure) of a selection of gases.

	K	$^{\circ}\text{C}$
He	4.22	-268.93
H <sub>2</sub>	20.28	-252.87
O <sub>2</sub>	54.36	-218.79
N <sub>2</sub>	77.36	-195.79
CH <sub>4</sub>	90.7	-182.45
C <sub>2</sub> H <sub>6</sub>	184.6	-88.55
C <sub>3</sub> H <sub>8</sub>	231	-42.15

**Table 9.1:** Normal boiling points of some gases

Liquid nitrogen is perhaps the most widely used cryogenic refrigerant, while liquid helium achieves the lowest temperatures. Since we do not find the gases listed in Table 9.2 occurring naturally in the pure, liquid state, clearly there needs to be some way of producing them.

## 9.2 Gas Liquefaction

In order to liquefy a gas using the standard vapour compression cycle, we would need a refrigerant with a very low evaporation temperature – lower than the boiling point of the gas we are trying to liquefy. Instead we essentially use the gas we are trying to liquefy as the refrigerant, and use the cooling effect that accompanies the expansion of gases under most (but not all!) conditions. Figure 9.1a shows a schematic of a gas liquefaction process, and Figure 9.1b shows the cycle on a TS diagram.

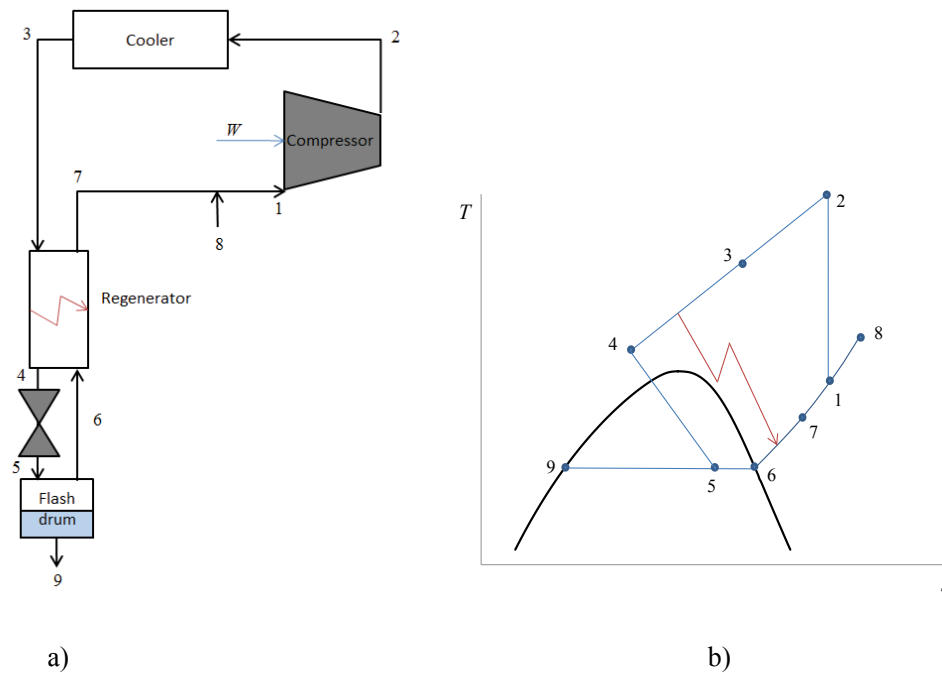

Figure 9.1: Gas liquefaction process, a) schematic diagram, b) TS diagram

To achieve the lowest temperature from an expansion process, we want the gas to be at as high a pressure as possible, and as low a temperature as possible at the inlet to the valve or throttle. Consider a gas at ambient conditions before it enters the compressor (State 1 in figure 9.1). If we compress it isentropically its temperature will increase (State 2). We should cool it isobarically down to as low a temperature as possible, firstly using some external cooling (State 3), but also relying on the fraction of gas that is not liquefied by the expansion process (State 4). Once we have cooled the gas as much as possible it is expanded through a throttle or valve into a flash drum (State 5) where a fraction of the gas is liquefied (State 9) and is the product, while the un-liquefied gas (State 6) is returned to the compressor via the regenerator where it transfers heat to the compressed gas which is being cooled prior to expansion. After the regenerator (State 7) the gas is mixed with make-up feed gas (State 8) before the cycle is repeated.

Referring to the TS diagram (Figure 9.1b), the closer State 5 is to State 9, the greater the fraction of liquid that is produced, and hence the more efficient the process is (on a mass basis). The work required to get the gas from State 1 to State 3 may be reduced significantly by using multi-stage compression. We could also potentially recover some work by expanding the gas through a turbine down to the start of the two-phase region, followed by expansion through a throttle for the remainder.

The liquefaction process is generally energy intensive, due to the large work of compression that is required as well as the need for external cooling, and hence cryogenic refrigeration tends to be very expensive (typically an order of magnitude more expensive than conventional vapour-compression refrigeration).

### 9.3 Summary of Chapter 9

Cryogenics refers to the study, production and application of low temperature. Simple cryogenic refrigerators operate by allowing a liquefied gas to evaporate at atmospheric pressure. Gases are liquefied by a process similar to the vapour compression cycle; however, the gas itself is essentially the working fluid.

### 9.4 Further Reading

*ASHRAE Handbook: Refrigeration*, American Society of Heating, Refrigeration and Air Conditioning Engineers, Atlanta, GA, 2010

Çengel, YA & Boles, MA, *Thermodynamics: An Engineering Approach*, 7<sup>th</sup> Ed., McGraw Hill, New York, 2011

Smith, JM, van Ness, HC & Abbott, MM, *Introduction to Chemical Engineering Thermodynamics*, 7<sup>th</sup> Ed., McGraw Hill, New York, 2005

# 10 List of Symbols:

$a$	cooling curve intercept (Eq. 6.2)	(m <sup>2</sup> )
$A$	area	(m <sup>2</sup> )
$b$	cooling curve slope (Eq. 6.2)	(s <sup>-1</sup> )
$Bi$	Biot Number defined by Eq. 3.22	
$C$	number of components in a system	
$C_p$	specific heat capacity at constant pressure	(J kg <sup>-1</sup> K <sup>-1</sup> )
$C_v$	specific heat capacity at constant volume	(J kg <sup>-1</sup> K <sup>-1</sup> )
$E$	equivalent heat transfer dimensionality	
$f$	cooling curve time constant (Eq. 6.5)	(s)
$F$	number of degrees of freedom	
$ Fo$	Fourier Number defined by Eq. 3.21	
$G$	shape factor defined in Chapter 6	
$h$	heat transfer coefficient	(W m <sup>-2</sup> k <sup>-1</sup> )
$h$	specific enthalpy	(J kg <sup>-1</sup> )
$H$	enthalpy	(J)
$j$	cooling curve intercept (Eq. 6.5)	
$k$	thermal conductivity	(W m <sup>-1</sup> k <sup>-1</sup> )
$L$	length	(m)
$L$	shortest distance between centre and surface	(m)
$N$	number of phases in a system	
$P$	pressure	(Pa)
$P_1, P_2$	shape factors defined in Chapter 6	
$Q$	heat	(J)
$\dot{Q}$	heat flow	(W)
$r$	radial dimension	(m)
$R$	radius	(m)
$R$	universal gas constant	8.314 (J mol <sup>-1</sup> K <sup>-1</sup> )
$s$	specific entropy	(J kg <sup>-1</sup> K <sup>-1</sup> )
$S$	entropy	(J K <sup>-1</sup> )
$S_1, S_2$	shape factors defined in Chapter 6	
$T$	temperature	(°C or K)
$U$	internal energy	(J or J kg <sup>-1</sup> )



$V$	volume	$(\text{m}^3)$
$x, y, z$	Cartesian coordinates	
$\theta$	dimensionless temperature change defined by Eq. 3.20	
$\lambda$	function of $Bi$ , defined for a sphere by Eq. 3.23	
$\rho$	density	$(\text{kg m}^{-3})$
$\psi$	Function defined for a sphere by Eq. 3.24	
$\zeta$	Function defined for a sphere by Eq. 3.25	
$\xi_1, \xi_2, \xi_3, \xi_4,$	intermediate variables defined by Eqs. 6.27 to 6.30	

## Subscripts

$0$	initial state
$C$	cold heat transfer process
$f$	frozen state
$H$	hot heat transfer process
$i$	inside/inlet
$n$	index of infinite series in Eq. 3.20
$Net$	net quantity
$r$	radial direction
$rev$	thermodynamically reversible process
$s$	surface
$sph$	sphere
$o$	outside/outlet
$u$	unfrozen state
$x$	$x$ direction

# 11 Appendix: Physical Properties of Refrigerant R134a

**Table A1:** Properties of saturated R134a refrigerant  
(Generated from data available at [webbook.nist.gov](http://webbook.nist.gov))

$T$ °C	$p^{\text{sat}}$ MPa	$h_f$ kJ kg <sup>-1</sup>	$h_{fg}$ kJ kg <sup>-1</sup>	$h_g$ kJ kg <sup>-1</sup>	$s_f$ kJ kg <sup>-1</sup> K <sup>-1</sup>	$s_{fg}$ kJ kg <sup>-1</sup> K <sup>-1</sup>	$s_g$ kJ kg <sup>-1</sup> K <sup>-1</sup>
-60	0.015906	123.46	237.85	361.31	0.68462	1.11638	1.801
-58	0.018091	125.81	236.77	362.58	0.69605	1.10045	1.7965
-56	0.020518	128.27	235.57	363.84	0.70741	1.08479	1.7922
-54	0.023206	130.73	234.38	365.11	0.71868	1.06952	1.7882
-52	0.026176	133.20	233.18	366.38	0.72988	1.05442	1.7843
-50	0.029451	135.67	231.98	367.65	0.74101	1.03959	1.7806
-48	0.033051	138.15	230.77	368.92	0.75207	1.02493	1.777
-46	0.037003	140.64	229.55	370.19	0.76305	1.01055	1.7736
-44	0.041329	143.14	228.32	371.46	0.77397	0.99643	1.7704
-42	0.046055	145.64	227.09	372.73	0.78482	0.98248	1.7673
-40	0.051209	148.14	225.86	374.00	0.79561	0.96869	1.7643
-38	0.056817	150.66	224.61	375.27	0.80633	0.95517	1.7615
-36	0.062908	153.18	223.36	376.54	0.81700	0.94180	1.7588
-34	0.069512	155.71	222.09	377.80	0.82760	0.92870	1.7563
-32	0.076658	158.25	220.81	379.06	0.83814	0.91566	1.7538
-30	0.084378	160.79	219.53	380.32	0.84863	0.90287	1.7515
-28	0.092703	163.34	218.23	381.57	0.85906	0.89014	1.7492
-26	0.101670	165.9	216.92	382.82	0.86943	0.87767	1.7471
-24	0.111300	168.47	215.6	384.07	0.87975	0.86535	1.7451
-22	0.12165	171.05	214.27	385.32	0.89002	0.85318	1.7432
-20	0.13273	173.64	212.91	386.55	0.90025	0.84105	1.7413
-18	0.14460	176.23	211.56	387.79	0.91042	0.82748	1.7379
-16	0.15728	178.83	210.19	389.02	0.92054	0.81736	1.7379
-14	0.17082	181.44	208.8	390.24	0.93062	0.80568	1.7363
-12	0.18524	184.07	207.39	391.46	0.94066	0.79414	1.7348
-10	0.20060	186.70	205.96	392.66	0.95065	0.78275	1.7334
-8	0.21693	189.34	204.53	393.87	0.9606	0.7714	1.732
-6	0.23428	191.99	203.07	395.06	0.97051	0.76019	1.7307
-4	0.25268	194.65	201.60	396.25	0.98037	0.74903	1.7294
-2	0.27217	197.32	200.11	397.43	0.99021	0.73799	1.7282

**Table A1:** Properties of saturated R134a refrigerant – continued

$T$ °C	$p^{\text{sat}}$ MPa	$h_f$ kJ kg <sup>-1</sup>	$h_{fg}$ kJ kg <sup>-1</sup>	$h_g$ kJ kg <sup>-1</sup>	$s_f$ kJ kg <sup>-1</sup> K <sup>-1</sup>	$s_{fg}$ kJ kg <sup>-1</sup> K <sup>-1</sup>	$s_g$ kJ kg <sup>-1</sup> K <sup>-1</sup>
0	0.2928	200	198.6	398.6	1	0.7271	1.7271
2	0.31462	202.69	197.08	399.77	1.0098	0.7162	1.726
4	0.33766	205.4	195.52	400.92	1.0195	0.7055	1.725
6	0.36198	208.11	193.95	402.06	1.0292	0.6948	1.724
8	0.38761	210.84	192.36	403.2	1.0388	0.6842	1.723
10	0.41461	213.58	190.74	404.32	1.0485	0.6736	1.7221
12	0.44301	216.33	189.1	405.43	1.0581	0.6631	1.7212
14	0.47288	219.09	187.44	406.53	1.0677	0.6527	1.7204
16	0.50425	221.87	185.74	407.61	1.0772	0.6424	1.7196
18	0.53718	224.66	184.03	408.69	1.0867	0.6321	1.7188
20	0.57171	227.47	182.28	409.75	1.0962	0.6218	1.718
22	0.60789	230.29	180.5	410.79	1.1057	0.6116	1.7173
24	0.64578	233.12	178.7	411.82	1.1152	0.6014	1.7166
26	0.68453	235.97	176.87	412.84	1.1246	0.5913	1.7159
28	0.72688	238.84	175	413.84	1.1341	0.5811	1.7152
30	0.7702	241.72	173.1	414.82	1.1435	0.571	1.7145
32	0.81543	244.62	171.16	415.78	1.1529	0.5609	1.7138
34	0.86263	247.54	169.18	416.72	1.1623	0.5508	1.7131
36	0.91185	250.48	167.17	417.65	1.1717	0.5407	1.7124
38	0.96315	253.43	165.12	418.55	1.1811	0.5307	1.7118
40	1.0166	256.41	163.02	419.43	1.1905	0.5206	1.7111
42	1.0722	259.41	160.87	420.28	1.1999	0.5104	1.7103
44	1.1301	262.43	158.68	421.11	1.2092	0.5004	1.7096
46	1.1903	265.47	156.45	421.92	1.2186	0.4903	1.7089
48	1.2529	268.53	154.16	422.69	1.228	0.4801	1.7081
50	1.3179	271.62	151.82	423.44	1.2375	0.4697	1.7072
52	1.3854	274.74	149.41	424.15	1.2469	0.4595	1.7064
54	1.4555	277.89	146.94	424.83	1.2563	0.4492	1.7055
56	1.5282	281.06	144.41	425.47	1.2658	0.4387	1.7045
58	1.6036	284.27	141.8	426.07	1.2753	0.4282	1.7035
60	1.6818	287.5	139.13	426.63	1.2848	0.4176	1.7024
62	1.7628	290.78	136.36	427.14	1.2944	0.4069	1.7013
64	1.8467	294.09	133.52	427.61	1.304	0.396	1.7
66	1.9337	297.44	130.58	428.02	1.3137	0.385	1.6987

**Table A1:** Properties of saturated R134a refrigerant – continued

$T$ °C	$p^{\text{sat}}$ MPa	$h_f$ kJ kg <sup>-1</sup>	$h_{fg}$ kJ kg <sup>-1</sup>	$h_g$ kJ kg <sup>-1</sup>	$s_f$ kJ kg <sup>-1</sup> K <sup>-1</sup>	$s_{fg}$ kJ kg <sup>-1</sup> K <sup>-1</sup>	$s_g$ kJ kg <sup>-1</sup> K <sup>-1</sup>
68	2.0237	300.84	127.52	428.36	1.3234	0.3738	1.6972
70	2.1168	304.28	124.37	428.65	1.3332	0.3624	1.6956
72	2.2132	307.78	121.08	428.86	1.343	0.3509	1.6939
74	2.313	311.33	117.67	429	1.353	0.339	1.692
76	2.4161	314.94	114.1	429.04	1.3631	0.3268	1.6899
78	2.5228	318.63	110.35	428.98	1.3733	0.3143	1.6876
80	2.6332	322.39	106.42	428.81	1.3836	0.3014	1.685
82	2.7473	326.24	102.27	428.51	1.3942	0.2879	1.6821
84	2.8653	330.2	97.85	428.05	1.4049	0.274	1.6789
86	2.9874	334.28	93.14	427.42	1.4159	0.2593	1.6752
88	3.1136	338.51	88.04	426.55	1.4273	0.2437	1.671
90	3.2442	342.93	82.49	425.42	1.439	0.2272	1.6662
92	3.3793	347.59	76.33	423.92	1.4514	0.209	1.6604
94	3.5193	352.58	69.34	421.92	1.4645	0.1889	1.6534
96	3.6645	358.07	61.11	419.18	1.4789	0.1656	1.6445
98	3.8152	364.47	50.67	415.14	1.4957	0.1365	1.6322
100	3.9724	373.3	34.38	407.68	1.5188	0.0921	1.6109
101	4.0541	384.35	11.08	395.43	1.548	0.0296	1.5776
101.06	4.05928	389.89	0	389.89	1.5628	0	1.5628

**Table A2:** Properties of Superheated Refrigerant R134a  
(Generated from data available at [webbook.nist.gov](http://webbook.nist.gov))

$T$ °C	$P = 0.1$ MPa		$P = 0.2$ MPa		$P = 0.3$ MPa		$P = 0.4$ MPa	
	$h$ kJ kg <sup>-1</sup>	$s$ kJ kg <sup>-1</sup> K <sup>-1</sup>	$h$ kJ kg <sup>-1</sup>	$s$ kJ kg <sup>-1</sup> K <sup>-1</sup>	$h$ kJ kg <sup>-1</sup>	$s$ kJ kg <sup>-1</sup> K <sup>-1</sup>	$h$ kJ kg <sup>-1</sup>	$s$ kJ kg <sup>-1</sup> K <sup>-1</sup>
-20	387.65	1.7677						
-15	391.63	1.7833						
-10	395.64	1.7986	392.68	1.7337				
-5	399.67	1.8138	396.94	1.7497				
0	403.73	1.8288	401.2	1.7654				
5	407.82	1.8437	405.45	1.7808	402.88	1.7408		
10	411.95	1.8584	409.73	1.7961	407.34	1.7567	404.72	1.7261
15	416.11	1.873	414.02	1.8111	411.79	1.7722	409.38	1.7425

**Table A2:** Properties of Superheated Refrigerant R134a – continued

$T$ °C	$P = 0.1$ MPa		$P = 0.2$ MPa		$P = 0.3$ MPa		$P = 0.4$ MPa	
	$h$ kJ kg <sup>-1</sup>	$s$ kJ kg <sup>-1</sup> K <sup>-1</sup>	$h$ kJ kg <sup>-1</sup>	$s$ kJ kg <sup>-1</sup> K <sup>-1</sup>	$h$ kJ kg <sup>-1</sup>	$s$ kJ kg <sup>-1</sup> K <sup>-1</sup>	$h$ kJ kg <sup>-1</sup>	$s$ kJ kg <sup>-1</sup> K <sup>-1</sup>
20	420.31	1.8874	418.33	1.8259	416.24	1.7876	414.01	1.7584
25	424.55	1.9017	422.67	1.8406	420.7	1.8027	418.62	1.774
30	428.82	1.916	427.04	1.8551	425.17	1.8175	423.22	1.7893
35	433.14	1.9301	431.44	1.8695	429.67	1.8323	427.83	1.8044
40	437.49	1.9441	435.87	1.8838	434.19	1.8468	432.45	1.8192
45	441.88	1.958	440.33	1.8979	438.73	1.8612	437.08	1.8339
50	446.3	1.9718	444.83	1.912	443.31	1.8755	441.74	1.8484
55	450.77	1.9855	449.36	1.9259	447.91	1.8896	446.41	1.8628
60	455.28	1.9991	453.92	1.9397	452.53	1.9036	451.11	1.877
65	459.82	2.0127	458.52	1.9534	457.19	1.9175	455.83	1.8911
70	464.41	2.0261	463.16	1.967	461.89	1.9312	460.58	1.905
75	469.03	2.0395	467.83	1.9805	466.61	1.9449	465.36	1.9188
80	473.7	2.0528	472.54	1.9939	471.37	1.9585	470.17	1.9325
85	478.4	2.066	477.29	2.0073	476.16	1.9719	475.01	1.9461
90	483.14	2.0792	482.07	2.0206	480.99	1.9853	479.88	1.9597
95	487.92	2.0923	486.89	2.0337	485.85	1.9986	484.78	1.9731
100	492.74	2.1053	491.75	2.0468	490.74	2.0118	489.72	1.9864
105					495.67	2.0249	494.68	1.9996
110					500.63	2.038	499.68	2.0127
115					505.63	2.051	504.71	2.0258
120					510.67	2.0638	509.78	2.0387
125					515.74	2.0767	514.88	2.0516
130					520.85	2.0894	520.02	2.0645
135								
140								
-20								
-15								
-10								
-5								
0								
5								
10								
15								

**Table A2:** Properties of Superheated Refrigerant R134a – continued

$T$ °C	$P = 0.1$ MPa		$P = 0.2$ MPa		$P = 0.3$ MPa		$P = 0.4$ MPa	
	$h$ kJ kg <sup>-1</sup>	$s$ kJ kg <sup>-1</sup> K <sup>-1</sup>	$h$ kJ kg <sup>-1</sup>	$s$ kJ kg <sup>-1</sup> K <sup>-1</sup>	$h$ kJ kg <sup>-1</sup>	$s$ kJ kg <sup>-1</sup> K <sup>-1</sup>	$h$ kJ kg <sup>-1</sup>	$s$ kJ kg <sup>-1</sup> K <sup>-1</sup>
20	411.61	1.7339						
25	416.4	1.7501	414.01	1.7291				
30	421.16	1.7659	418.96	1.7455	416.6	1.7269		
35	425.9	1.7814	423.86	1.7616	421.69	1.7436	419.37	1.7268
40	430.63	1.7967	428.73	1.7772	426.72	1.7598	424.59	1.7436
45	435.37	1.8117	433.58	1.7926	431.71	1.7756	429.74	1.7599
50	440.11	1.8265	438.43	1.8077	436.67	1.791	434.84	1.7758
55	444.87	1.8411	443.28	1.8266	441.62	1.8062	439.91	1.7914
60	449.64	1.8555	448.13	1.8373	446.57	1.8212	444.95	1.8067
65	454.43	1.8698	453	1.8518	451.52	1.8359	449.99	1.8217
70	459.25	1.8839	457.88	1.8661	456.47	1.8505	455.03	1.8365
75	464.09	1.8979	462.78	1.8803	461.44	1.8649	460.07	1.851
80	468.95	1.9118	467.7	1.8943	466.42	1.8791	465.12	1.8654
85	473.84	1.9256	472.64	1.9082	471.42	1.8931	470.18	1.8797
90	478.76	1.9392	477.61	1.922	476.44	1.907	475.25	1.8937
95	483.7	1.9527	482.6	1.9356	481.48	1.9208	480.34	1.9076
100	488.68	1.9661	487.62	1.9492	486.54	1.9345	485.45	1.9214
105	493.69	1.9795	492.66	1.9626	491.63	1.948	490.58	1.9351
110	498.72	1.9927	497.74	1.9759	496.74	1.9615	495.74	1.9486
115	503.78	2.0058	502.84	1.9892	501.88	1.9748	500.91	1.9621
120	508.88	2.0189	507.97	2.0023	507.05	1.988	506.12	1.9754
125	514.01	2.0318	513.13	2.0154	512.24	2.0011	511.34	1.9886
130	519.18	2.0447	518.33	2.0283	517.47	2.0142	516.6	2.0017
135	524.37	2.0575	523.55	2.0412	522.72	2.0271	521.88	2.0147
140	529.6	2.0703	528.81	2.054	528.01	2.04	527.2	2.0277
145					533.32	2.0528	532.54	2.0405
150					538.67	2.0655	537.91	2.0533

**Table A2:** Properties of Superheated Refrigerant R134a – continued

$T$ °C	$P = 1.8 \text{ MPa}$		$P = 2.0 \text{ MPa}$	
	$h$ kJ kg <sup>-1</sup>	$s$ kJ kg <sup>-1</sup> K <sup>-1</sup>	$h$ kJ kg <sup>-1</sup>	$s$ kJ kg <sup>-1</sup> K <sup>-1</sup>
-20				
-15				
-10				
-5				
0				
5				
10				
15				
20				
25				
30				
35				
40				
45				
50				
55				
60				
65	430.33	1.7095		
70	437.07	1.7293	432.06	1.7086
75	443.48	1.7479	439.12	1.7291
80	449.67	1.7655	445.77	1.7481
85	455.71	1.7825	452.17	1.766
90	461.63	1.7989	458.38	1.7833
95	467.47	1.8149	464.47	1.7999
100	473.25	1.8305	470.45	1.816
105	478.98	1.8458	476.36	1.8318
110	484.68	1.8607	482.21	1.8471
115	490.36	1.8754	488.02	1.8622
120	496.02	1.8899	493.8	1.877
125	501.67	1.9042	499.56	1.8916
130	507.32	1.9183	505.31	1.9059
135	512.96	1.9322	511.04	1.9201
140	518.61	1.946	516.78	1.934
145	524.27	1.9596	522.51	1.9478
150	529.93	1.9731	528.24	1.9614

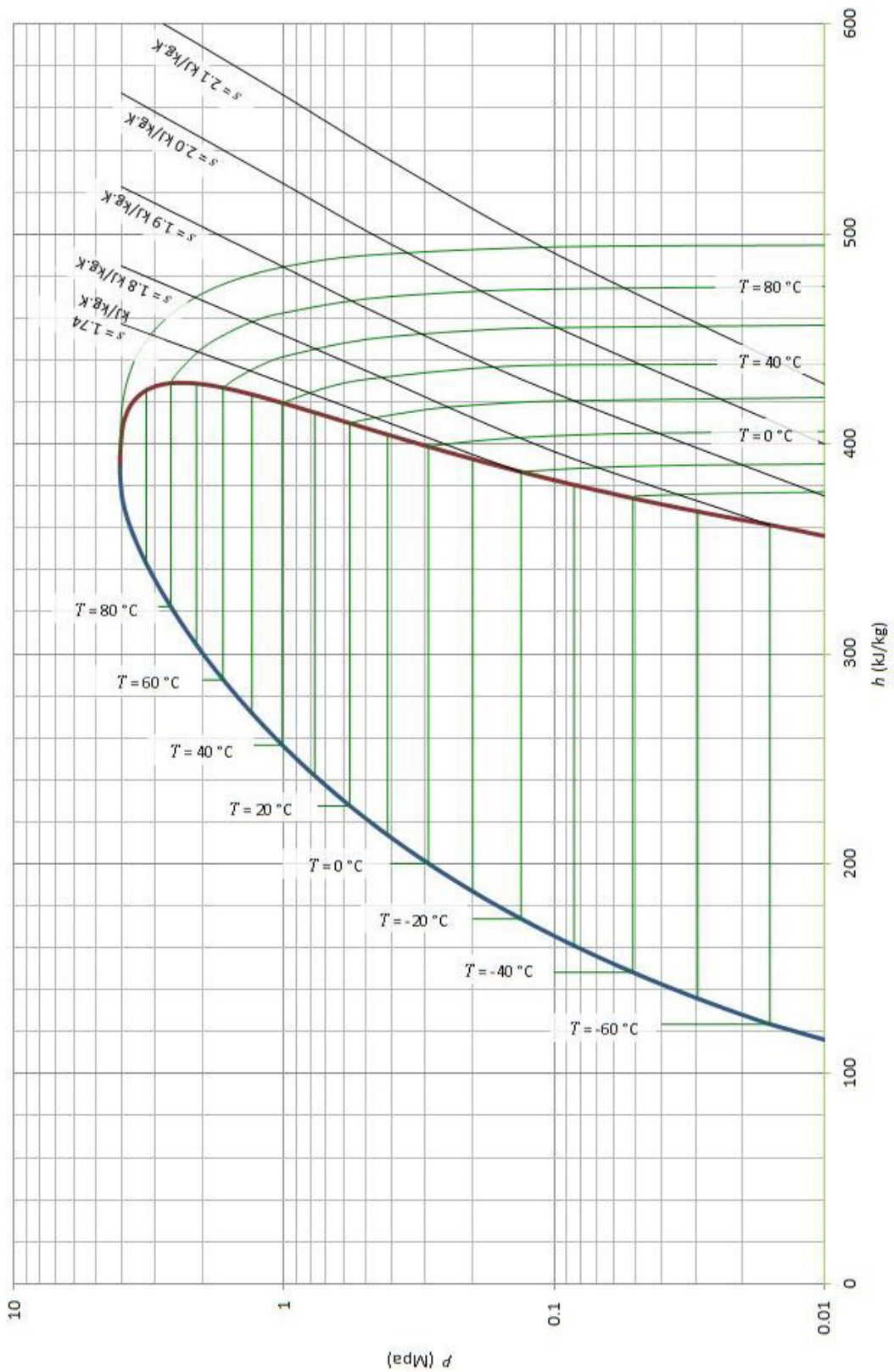

**Figure A1:** Pressure-enthalpy diagram of R134a refrigerant