

Prof. Satindar Bhagat

Elementary Physics – II

Oscillations, Waves: Sound and Electromagnetic/Light

Elementary Physics – II: Oscillations, Waves: Sound and Electromagnetic/Light

2nd edition

© 2015 Prof. Satindar Bhagat & bookboon.com

ISBN 978-87-403-0823-5

Contents

1	Introduction	11
2	Linear Harmonic Mechanical Oscillators	13
2.1	Spring-Mass Oscillator (Horizontal)	13
2.2	Spring-Mass Oscillator (Vertical)	18
2.3	Simple pendulum	20
2.4	Sphere with a Diametric Hole	22
3	Linear Harmonic Oscillators	23
3.1	Simple pendulum revisited	24
3.2	Physical pendulums	25
4	Mechanical Waves (Travelling)	26
4.1	Periodic Waves	27
4.2	Speed Of Transverse Pulse On A Stretched String, Periodic Wave, Energy Transport	30
4.3	Energy transport by sine wave on string	33
4.4	Standing Waves/String Instruments	35
4.5	Appendix	39



www.sylvania.com

**We do not reinvent
the wheel we reinvent
light.**

Fascinating lighting offers an infinite spectrum of possibilities: Innovative technologies and new markets provide both opportunities and challenges. An environment in which your expertise is in high demand. Enjoy the supportive working atmosphere within our global group and benefit from international career paths. Implement sustainable ideas in close cooperation with other specialists and contribute to influencing our future. Come and join us in reinventing light every day.

Light is OSRAM

**OSRAM
SYLVANIA** 

5	Sound	40
5.1	Special note	42
5.2	<i>Intensity of Sound</i> – Experiment	44
5.3	Level of Sound – Decibel Scale	45
5.4	Intensity Of Sound – Periodic Wave	47
5.5	Sound-wind instruments	47
5.6	Sound-doppler effect	52
5.7	Sound waves-beats	56
5.8	Sound waves-interference	58
6	Trig Identity	61
7	Charge – Electrostatic (Coulomb Force)	62
7.1	Properties of Charge	63
7.2	Charges in Matter	64
8	Coulomb Force	65
8.1	Special cases	68



Discover the truth at www.deloitte.ca/careers

Deloitte.

© Deloitte & Touche LLP and affiliated entities.



Click on the ad to read more

9	The \vec{E} Field Coulomb / Gravitational Field	70
9.1	Formal Definitions:	71
9.2	Properties of \vec{E} -Field Lines:	73
10	Dipole In An \vec{E}-Field	75
11	Flux of \vec{E}-Field: Coulomb \vec{E}-Field, Gauss' Law	80
11.1	Example 1	84
11.2	Example 2	84
11.3	Example 3	85
11.4	Example 4	87
12	Energy Conservation Principle Revisited: Electric Potential	93
12.1	Electric Potentials – Special Cases	99
12.2	Equipotentials	103

SIMPLY CLEVER

ŠKODA



We will turn your CV into an opportunity of a lifetime



Do you like cars? Would you like to be a part of a successful brand? We will appreciate and reward both your enthusiasm and talent. Send us your CV. You will be surprised where it can take you.

Send us your CV on www.employerforlife.com



Click on the ad to read more

13	Devices Based On Coulomb \underline{E}-Field	104
13.1	Capacitor	105
13.1	Resistor	112
13.3	Electrical Conductivity	114
13.4	Multiple Capacitors	116
113.5	Multiple Resistors	118
14	Dc-Circuits: Battery + Resistors + Capacitors	120
14.1	Ideal Battery + Resistor	120
14.2	Real Battery + Resistor	121
14.3	Next, put all 3-devices together in a Circuit:	123
14.3	Kirchhoff's Rules: Physical Basis	127
15	Fields: Gravitational, Coulomb \underline{E}, \underline{B}	129
15.1	Problem I	131
15.2	Problem II	133
15.3	Problem III	133

I joined MITAS because
I wanted **real responsibility**

The Graduate Programme
for Engineers and Geoscientists
www.discovermitas.com



Month 16

I was a construction
supervisor in
the North Sea
advising and
helping foremen
solve problems

Real work
International opportunities
Three work placements



 **MAERSK**



Click on the ad to read more

16	Generation of A \underline{B} Field	138
16.1	Cases Of Special Interest	139
16.2	Current-Current force	142
17	Ampere’s Law and its Applications	144
17.1	Applications	146
18	Devices Using \underline{E} And \underline{B} Fields Cyclotron	153
18.1	Velocity Selector	154
18.2	Mass Spectrometer	S155
19	Magnetism	156
19.1	A “Bar” Magnet	156
19.1	<i>Gauss’s Law For \underline{B}</i>	162
20	Non-Coulomb \underline{E} Field (Induction)	164
20.1	Applications	167
20.2	Non-Coulomb \underline{S} [Motional ϵmf]	171

ie business school

#1 EUROPEAN BUSINESS SCHOOL
FINANCIAL TIMES 2013

#gobeyond

MASTER IN MANAGEMENT

Because achieving your dreams is your greatest challenge. IE Business School’s Master in Management taught in English, Spanish or bilingually, trains young high performance professionals at the beginning of their career through an innovative and stimulating program that will help them reach their full potential.

- Choose your area of specialization.
- Customize your master through the different options offered.
- Global Immersion Weeks in locations such as London, Silicon Valley or Shanghai.

Because you change, we change with you.

www.ie.edu/master-management | mim.admissions@ie.edu |



21	Devices For Non-Coulomb \vec{E}	174
21.1	Self Inductance $\frac{\Delta i}{\Delta t}$ and ϵ in the same coil	174
21.2	Mutual Inductance	175
21.3	Devices L-R Circuits	178
21.4	Exponential functions	183
21.5	Devices – AC Generator	184
22	Devices – Ac Circuits	187
22.1	Circuits	189
22.2	RL With Battery	190
22.2	<i>LC-Circuit</i> : Undamped Oscillator	191
22.4	<i>LCR-CIRCUIT</i> : DAMPED OSCILLATOR	192
22.4	Circuits: AC	194
22.5	Generator with all three	198
23	Maxwell's Equations: Radiation \rightarrow Light	206
23.1	Maxwell's Equations	209
23.2	Electromagnetic or EM field	210
23.3	Periodic EM Waves	211
23.4	Spectrum of EM-Waves – Light	215
23.5	Compare Mechanical And Em Waves	216
23.6	<i>EM-wave Light</i> : Intensity	216
24	Geometrical Optics	217
24.1	Fermat's Principle: LIGHT INVARIABLY CHOOSES A PATH WHICH TAKES THE LEAST TIME OF TRAVEL	218
24.2	Snell's Law	221
24.3	Some Applications	221
24.4	Total Internal Reflection	224
24.5	Newton's Experiments	226
25	Formation Of Image – Mirrors	227
25.1	General Construct to locate image of a point object O using the laws of reflection and refraction to locate the path of light	227
25.2	Mirror	229
25.3	Plane Mirror: Plane, silvered sheet of glass	229
25.4	Spherical Mirrors: Mirror cut from a spherical shell of radius R .	230
25.5	Images in Concave Mirror	232
25.6	Special Cases [Eqs. (1) And (2)]	233
25.7	Images in Convex Mirror	236

26	Formation Of Images – Refraction At A Single Surface	239
26.1	Apparent Depth of Water in a Pool	239
26.2	Single Convex Surface (positive r)	240
26.3	Single Concave Surface (negative r)	244
27	Formation Of Images – Thin Lenses	246
27.1	Lens	246
27.2	Image Formation	248
27.3	Divergent Lens	250
28	Wave Optics: Interference And Diffraction	251
28.1	Radiation: Electromagnetic wave	251
28.2	Superposition:	252
28.3	Double Slit Interference	253
28.4	Thin Film Interference	257
28.5	Multiple Source Interference – All Sources Coherent	259
29	Diffraction – Single Slit	260
29.1	Two-Slit Expt: Interference + Diffraction	264
30	Problems in Elementary Physics	265
30.1	Problems: Week 1	265
30.2	Problems: Week 2	268
30.3	Problems: Week 3	271
30.4	Problems: Week 4	274
30.6	Problems: Week 6	280
30.7	Problems: Week 7	282
30.8	Problems: Week 8	286
30.9	Problems: Week 9	290
30.10	Problems: Week 10	294
30.11	Problems: Week 11	298
30.12	Problems: Week 12	301
30.13	Problems: Week 13	304
30.14	Problems: Week 14	306

1 Introduction

Where have we been and where are we going? When we began our study of Physics we referred to two fields of intellectual endeavor. The Physicist attempts to (i) provide the simplest and most economical description of nature as we know it and, at a more basic level, (ii) uses intuition and imagination to propose a new fundamental idea to go back to nature to ascertain its applicability and develop a deeper understanding of its origin. Most of our study in I focused on (i) where we discussed the motion of particles and rigid bodies followed by a brief discussion of Thermodynamics.

The only example of (ii) was Newton's brilliant introduction (in the mid 1600's) of the Universal Law of Gravitation

$$\underline{F}_G = -\frac{GM_1M_2}{r^2}\hat{r} \quad (1)$$

whose origins Newton did not understand and in fact were not elucidated until the early 1900's: First Cavendish had to measure G , then Faraday introduced (1800s) the concept of a field and nearly 100 years later, Einstein developed the bases for this extremely elegant equation. A single powerful idea led to 350 years of hard work for some of the foremost thinkers. In II we will build on what we learned in I to understand the nature of waves: sound and light. Again, most of it will be focused on explaining observations but there will be one example of an absolutely astounding power of the human mind: J.C. Maxwell's.

<u>Physical Quantity</u>	<u>Dimensions</u>	<u>Unit</u>	<u>Scalar/Vector</u>
Amplitude (Oscillator)	L^1	m	V
Angular Frequency	T^{-1}	rad/sec	S
Phase	L^0	rad	S
Wavelength	L^1	m	S
Amplitude (wave)	Various (Displacement, Pressure..)		
Linear Density	ML^{-1}	kg/m	S
Intensity	MT^{-3}	Watt/m ²	S
Sound Level	—	dB	S
Charge	Q^1	Coulomb (C)	S
k_e	$ML^3 T^{-2} Q^{-2}$	N-m ² /C ²	S
E - field	$ML T^{-2} Q^{-1}$	N/C or V/m	V

Master table: contd from I

G – field	LT^{-2}	m/s^2	V
Flux of E	$ML^3 T^{-2} Q^{-1}$	$\frac{N-m^2}{\epsilon}$	S
ϵ_0	$M^{-1} L^{-3} T^2 Q^2$	F/m	S
el. Potential	$ML^2 T^{-2} Q^{-1}$	Volt (V)	S
$\epsilon m f$	$ML^2 T^{-2} Q^{-1}$	Volt (V)	S
Capacitance	$Q^2 M^{-1} L^{-2} T^2$	Farad (F)	S
Dielectric Constant	Dimensionless	Const.	S
Energy Density (E – field)	$ML^{-1} T^{-2}$	J/m^3	S
Current	QT^{-1}	ampere (A)	S
Current Density	$QT^{-1} L^{-2}$	A/m^2	V
Resistance	$ML^2 T^{-1} Q^{-2}$	ohm (Ω)	S
Electrical Conductivity	$M^{-1} L^{-3} T Q^2$	$\Omega^{-1} -m^{-1}$	S
B – field (Magnetic Induction)	$MQ^{-1} T^{-1}$	Tesla (T)	V
μ_0	$MQ^{-2} L$	T-m/A	S
Circulation of \vec{B}	$MQ^{-1} T^{-1} L$	T-m	S
Magnetic Dipole Moment	$QT^{-1} L^2$	Amp $-m^2$	V
Flux of \vec{B}	$MQ^{-1} T^{-1} L^2$	T-m ²	S
H – field	$QT^{-1} L^{-1}$	A/m	V
Magnetization	$QT^{-1} L^{-1}$	A/m	V
Non – Coulomb \vec{E}	$MLT^{-2} Q^{-1}$	$\frac{N}{\epsilon}$ or $\frac{V}{m}$	V
Inductance	$ML^2 Q^{-2}$	Henry	S
Energy Density (B – field)	$ML^{-1} T^{-2}$	J/m^3	S
Self-Inductance	$ML^2 Q^{-2}$	Henry	S
Displacement Current	QT^{-1}	Amp.	S
Refractive Index	Dimensionless		

2 Linear Harmonic Mechanical Oscillators

(Translation)

Definition: A mass M will perform linear harmonic (or simple harmonic) oscillations about a point of equilibrium ($F = 0$) if it is acted upon by a force which is proportional to its displacement (x) from equilibrium and always acts in a direction opposite to the displacement vector.

So essential ingredients are:

Magnitude of F proportional to (x)

Direction of F opposite to (x)

Hence \vec{F} is called: RESTORING FORCE

Alternate Definition: The object has a potential energy which varies as the square of the displacement.

L.H. oscillations are ubiquitous in the physical world but to start with we consider only 4 realizations of the above definition.

2.1 Spring-Mass Oscillator (Horizontal)

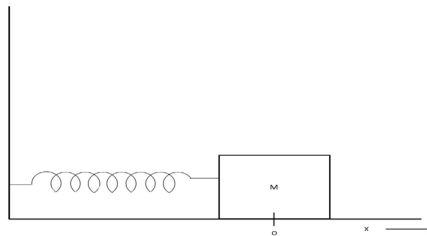

A mass M is attached to a spring of constant k . The other end of the spring is attached to a rigid post. M is placed on a smooth frictionless horizontal table such that when it is at $x=0$, the spring is relaxed so M is in $\equiv m$ as its weight is supported by N_R .

If we displace M by an amount x , immediately the spring force

$$\vec{F} = -kx\hat{x} \quad (1)$$

comes into play. So if after displacing M by an amount A we let go, M will be under the influence of the force of Eq (1) and will move back and forth as a L.H. oscillator.

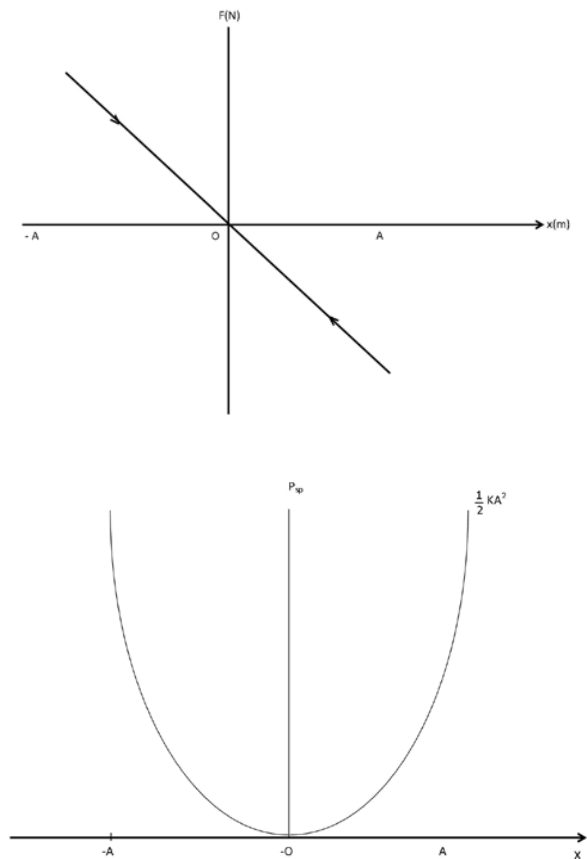

Why? When you let go, the mass experiences a force that brings it back to 0. But when it reaches 0 it has a kinetic energy and it cannot stop. So it keeps going until it gets to $-A$. But now again it has a force that wants to bring it back to 0. And there you have it. Every time it returns to $\equiv m$ it fails to stop and when it stops it is not in $\equiv m$.

The corresponding potential energy is $P_{sp} = \frac{1}{2}kx^2$

That is:

So at $x=A$, $P_{sp} = \frac{1}{2}kA^2$. Let go. P wants to reduce but when M reaches 0 ($x = 0$) P is converted to kinetic energy ($\frac{1}{2}MV_{\max}^2$) and that takes it to $-A$ where $P_{sp} = \frac{1}{2}kA^2$ again.

Kinetic energy:

Energy conservation requires

$$\frac{1}{2}kA^2 = \frac{1}{2}MV_{\max}^2 = \frac{1}{2}kx^2 + \frac{1}{2}MV^2 \tag{2}$$

where V is the speed when M is at any point x between 0 and A .

So the FORCE equation is

$$\vec{F} = -kx\hat{x}$$

and hence acceleration is

$$\vec{a} = -\frac{k}{m}x\hat{x} \quad (3)$$

[Never leave out the minus sign.]

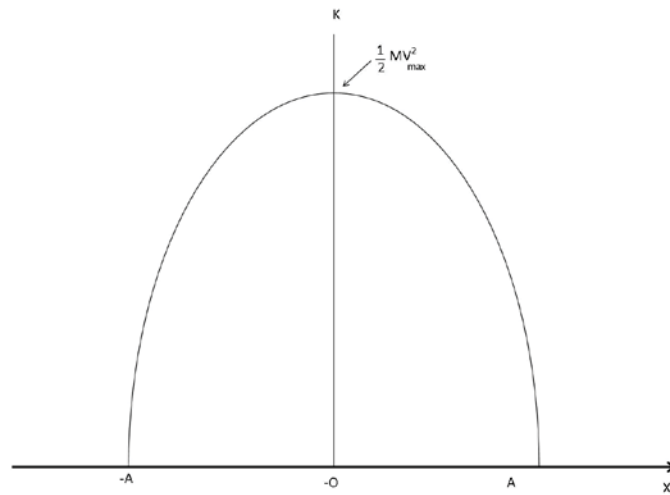

Uniform Circular Motion \leftrightarrow Simple Harmonic Oscillation

Point P travels on circle of radius A at constant angular velocity $\underline{\omega} = \omega\hat{z}$ (counter-clockwise).

Position Vector

$$\underline{r} = A\hat{r}$$

Velocity Vector

$$\underline{v} = A\omega\hat{\tau}$$

Acceleration Vector and $\Theta = \Theta_0 + \omega t$

$$\underline{a} = -A\omega^2\hat{r}$$

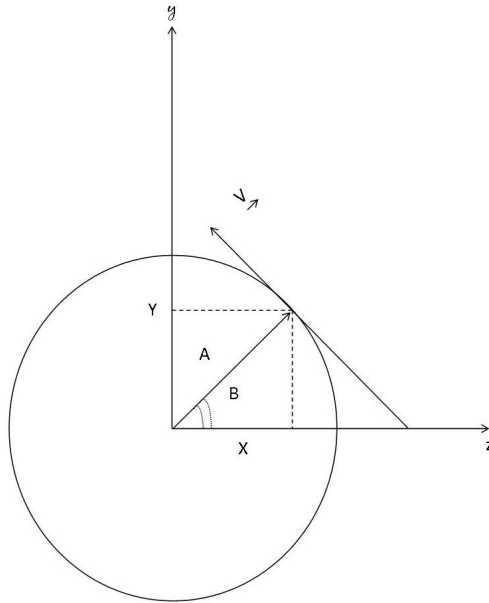

First

$$\begin{aligned} \underline{X}\text{-component position} \quad X &= A \cos \Theta \\ \text{velocity} \quad v_x &= -Aw \sin \Theta \\ \text{acceleration} \quad a_x &= -Aw^2 \cos \Theta = -w^2 X \end{aligned}$$

$$\text{Compare Eq (3) } \underline{a} = \frac{-k}{M} x \hat{x}$$

So as P goes around circle X mimics motion of linear harmonic oscillator with

$$w = \sqrt{\frac{k}{M}}$$

And we get equation 3.

$$\begin{aligned} \text{y-second component} \quad y &= A \sin \Theta \\ v_y &= Aw \cos \Theta \\ a_y &= -Aw^2 \sin \Theta = -w^2 Y \end{aligned}$$

and the variation of Y mimics a linear harmonic oscillator along y-axis

$$w = \sqrt{\frac{k}{m}}$$

$$y = A \sin(\omega t + \Theta_0)$$

$$v = Aw \cos(\omega t + \Theta_0)$$

$$\text{and} \quad a = -Aw^2 \sin(\omega t + \Theta_0)$$

As we showed above by reference to the case of uniform circular motion, the position, velocity (magnitude) and acceleration are given by

$$x = A \cos(\omega t + \theta_0) \quad (4)$$

$$V = -A\omega \sin(\omega t + \theta_0) \quad (5)$$

$$a = -A\omega^2 \cos(\omega t + \theta_0) = -\omega^2 x \quad (6)$$

where A = amplitude, the largest value of x and is determined by the potential energy stored in the spring mass system to initiate the motion.

and ω = Angular frequency

$$\omega = \sqrt{\frac{k}{M}}$$

and is related to the two fundamental properties of the oscillator.

Frequency $f = \frac{\omega}{2\pi}$ = # of oscillations per second

Period $T = \frac{1}{f}$ = time taken for one complete oscillation

θ_0 = phase and tells you precisely the position of M at $t = 0$. For example, if $\theta_0 = 0$, M is at A at $t = 0$. If $\theta_0 = \frac{\pi}{2}$, M is at 0 at $t = 0$.



STUDY AT A TOP RANKED INTERNATIONAL BUSINESS SCHOOL

Reach your full potential at the Stockholm School of Economics, in one of the most innovative cities in the world. The School is ranked by the Financial Times as the number one business school in the Nordic and Baltic countries.

Visit us at www.hhs.se





2.2 Spring-Mass Oscillator (Vertical)

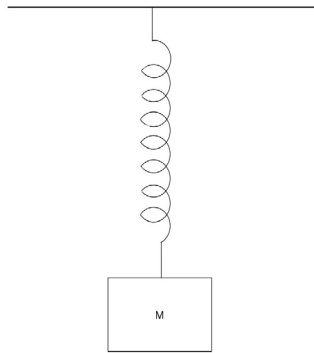

In this case, of course, as soon as you attach the mass, the spring will stretch. If you hold the mass and allow the stretching to happen while you keep holding it until the spring is fully stretched due to the force $-Mg \hat{y}$ and then let go, the mass will be in $\equiv m$ because spring force

$$F_{s_p} = -ky\hat{y}$$

Will be balancing $-Mg \hat{y}$

$$(-ky - Mg) \hat{y} = 0$$

i.e.
$$\Delta y = -\frac{Mg}{k}$$

to give
$$F_{s_p} \parallel +\hat{y}$$

Now, if you want m to oscillate you must pull it by an amount A , store $\frac{1}{2}kA^2$ energy in it and it will oscillate around the new $\equiv m$ pt. $\Delta y = -\frac{Mg}{k}$, A above and $-A$ below it.

Note that $-Mg \hat{y}$ is a constant force and is **not** a restoring force, so it **does not** affect the period of the oscillator. All it does is to move the point of $\equiv m$.

$$\omega \text{ is still equal to } = \sqrt{\frac{k}{M}}$$

$$T = 2\pi\sqrt{\frac{M}{k}}$$

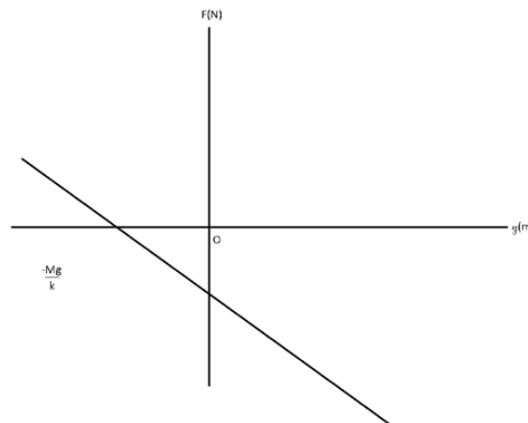

Alternate expt.

$y=0$. spring unstretched

Attach M .

Let go.

The mass will drop.

Come to rest.

Rise.

Oscillate.

How far is the initial drop?

Determined by conservation of energy.

$$\begin{array}{ll} \text{At } y = 0 & P_{sp} = 0 \\ & P_g = 0 \end{array} \quad \left[\begin{array}{l} P_{sp} = \frac{1}{2}ky^2 \\ P_g = Mgy \end{array} \right]$$

So now y max

$$\frac{1}{2}ky_{\max}^2 + Mgy_{\max} = 0$$

$$y_{\max} = -\frac{2Mg}{k}$$

Of course, = m pt. is still $y = -\frac{Mg}{k}$

So mass will oscillate between

$$y = 0 \text{ and } y = \frac{-2Mg}{k}$$

And again Mg cannot be a restoring force. Only $F_{\rightarrow sp}$ can do that, so

$$\omega = \sqrt{\frac{k}{M}}$$

Very interesting observation: The entire motion of the oscillator happens while total energy (kinetic plus potential) is equal to **zero**.

2.3 Simple pendulum

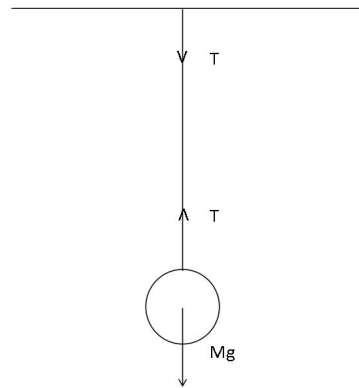

Mass M hung from a rigid support using a light string of length l [if mass has size l must be measured to its C.G.] When string is vertical (nearly) mass in $\equiv m$

$$T - Mg = 0$$

If you pull mass sideways by amount $+\theta_{\max}$ and let go it will oscillate between the θ_{\max} and $-\theta_{\max}$.

#1
in eco-friendly
attitude

**STUDY AT
LINKÖPING UNIVERSITY, SWEDEN**
RANKED AMONG TOP 50 UNIVERSITIES UNDER 50

Interested in Strategy and Management in International Organisations? Kick-start your career with a master's degree from Linköping University, Sweden.

→ **Click here!**

 **Linköping University**

Consider the forces at some angle θ . We can break $-Mg \hat{y}$ into its components:

1. along the string (radius of circle on which M travels)

$$Mg \cos \theta$$

2. Perpendicular to string (along tangent to circle on which M travels)

$$F_{\tau} = -Mg \sin \theta \hat{\tau}$$

Because of *-ive* sign it is certainly a restoring force, so that is good. But it is not proportional to displacement as it stands. However, if we play our cards right, we can make it so. Recall that when $\theta \ll 1$,

$$\sin \theta \approx \theta$$

So make sure θ is small!

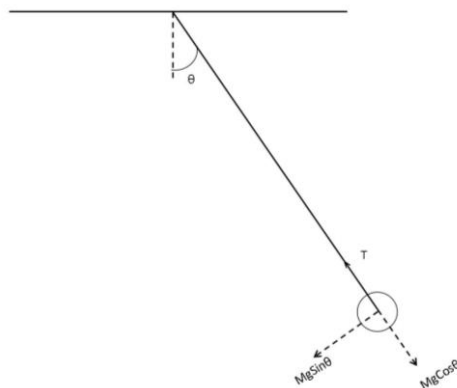

Then $F_{\tau} = -Mg \theta \hat{\tau}$

And that will give us LH oscillations.

Notice: $\theta = \frac{s}{l}$

Where s is displacement along arc.

So

$$F_{\tau} = \frac{-Mgs}{l} \hat{\tau}$$

$$a = \frac{-gs}{l} \hat{\tau}$$

$$= -\omega^2 s \hat{\tau}$$

And therefore angular frequency must be $\omega = \sqrt{\frac{g}{l}}$

And period becomes $T = 2\pi \sqrt{\frac{l}{g}}$

By analogy with case 1 above, we can write

$$S = A \cos(\omega t + \alpha), \quad A = l\theta_{\max}$$

Or $\theta = \theta_{\max} \cos(\omega t + \alpha)$

$$V_t = -A \omega \sin(\omega t + \alpha)$$

$$a_t = -\omega^2 A$$

Also, potential energy (assuming $P = 0$, when $\theta = 0$) is

$$P = Mgl(1 - \cos\theta)$$

But for $\theta \ll 1$

$$\cos\theta = 1 - \frac{\theta^2}{2}$$

$$\text{So, } P = \frac{Mgl\theta^2}{2}$$

Which is what we need for LH oscillators

2.4 Sphere with a Diametric Hole

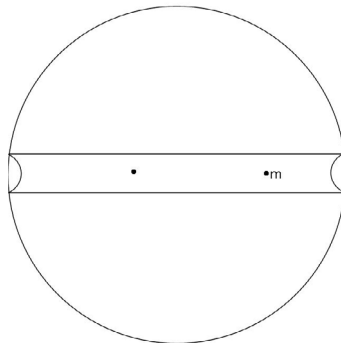

Take a uniform sphere made of a material of density d . Make a diametric hole in it (very narrow hole). In the hole, place a mass m at a distance r from the center of the sphere.

What is the gravitational force on m :

$$\vec{F}_G = -\frac{4\pi}{3} Gd m r \hat{r}$$

It is a restoring force.

It is directly proportional to r .

If you let m go it will have LH oscillations with angular frequency

$$\omega = \sqrt{\frac{4\pi}{3} Gd}$$

So there!

3 Linear Harmonic Oscillators

(ROTATIONAL)

Definition: To get L.H. Oscillations involving rotation we need $\vec{\tau}$ a torque which is proportional to the angular displacement (θ) from equilibrium and is opposite to the displacement vector. That is,

$$\vec{\tau} = -c \vec{\theta}$$

In our case all rotations are about z -axis so

$$\vec{\tau} = -c \theta \hat{z}$$

And since

$$I \vec{\alpha} = \vec{\tau}$$

$$\vec{\alpha} = -\frac{c}{I} \theta \hat{z}$$

which by analogy with the prior discussion gives

$$\vec{\alpha} = -\omega^2 \theta \hat{z}$$

"I studied English for 16 years but...
...I finally learned to speak it in just six lessons"

Jane, Chinese architect

ENGLISH OUT THERE

Click to hear me talking before and after my unique course download

And so angular frequency

$$\omega = \sqrt{\frac{c}{I}}$$

Two examples follow, Note that Potential Energy is:

$$P_\theta = \frac{1}{2}c\theta^2 \quad \begin{cases} P_\theta = 0 \\ \theta = 0 \end{cases}$$

3.1 Simple pendulum revisited

Single mass point M moving on a circle of radius l . At angle θ .

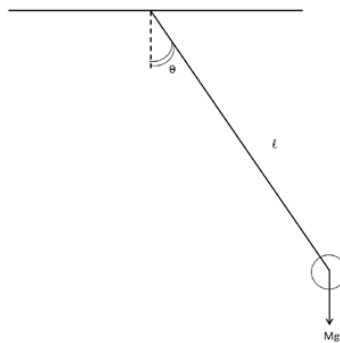

$$\begin{aligned} \vec{\tau} &= \vec{r} \times \vec{F} \\ &= -Mgl \sin \theta \hat{z} \end{aligned}$$

[for case shown]

and again we need $\theta \ll 1$, so that

$$\vec{\tau} \cong -Mgl\theta \hat{z}$$

Here $I = Ml^2$

$$\text{So } \vec{\alpha} = \frac{g}{l} \theta \hat{z}$$

and therefore

$$\omega = \sqrt{\frac{g}{l}} \quad \text{and} \quad T = 2\pi \sqrt{\frac{l}{g}}$$

as before.

3.2 Physical pendulums

Bar suspended from a rigid support at P . C.G is l meters away from P .

$$\vec{\tau} = -Mgl \sin \theta \hat{z}$$

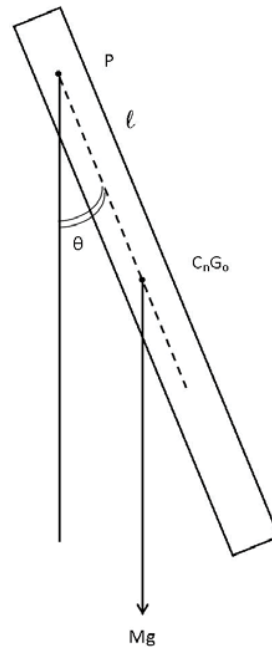

and for $\theta \ll 1$,

$$\begin{aligned} \vec{\tau} &= -Mgl \theta \hat{z} \\ &= I \vec{\alpha} \end{aligned}$$

so

$$\vec{\alpha} = \frac{-Mgl}{I} \theta \hat{z}$$

yielding

$$\omega = \sqrt{\frac{Mgl}{I}}$$

4 Mechanical Waves (Travelling)

We begin our discussion of the wave phenomenon by considering waves in matter. The simplest definition of a wave is to call it a traveling disturbance (or equivalently, deviation from equilibrium). For instance, if you drop a stone on the surface of an undisturbed body of water you can watch the “disturbance” traveling radially out of the “point” of contact.

Formally, we can “construct” a wave in several steps. For simplicity, we take a wave traveling along x -axis.

Step 1. We need a disturbance D .

Step 2. D must be a function of x .

Step 3. D must also be a function of t .

Step 4. If x and t appear in the function in the combinations $(x \mp vt)$ the disturbance D **cannot** be stationary. It must travel along x with speed v .

Excellent Economics and Business programmes at:



university of
 groningen



“The perfect start
 of a successful,
 international career.”

CLICK HERE
 to discover why both socially
 and academically the University
 of Groningen is one of the best
 places for a student to be

www.rug.nl/feb/education

Further,

$$(x-vt) \text{ implies } \underset{\rightarrow}{v} = v \hat{x} [\text{travel in +ive } x - \text{direction}]$$

$$(x+vt) \text{ implies } \underset{\rightarrow}{v} = -v \hat{x} [\text{travel in -ive } x - \text{direction}]$$

EXERCISE: Put $D = A(x - t)^2$ and show that “parabola” travels.

4.1 Periodic Waves

The simplest wave is when $(x-vt)$ appears in a *sin* or *cos* function. $D = \sin(x-vt)$ But this equation is not justified. First, since D is a disturbance it must have dimensions so we need

$$D = A \sin(x - vt)$$

Where A has the dimensions of D . Next, argument of *Sin* **cannot** have dimensions, so we need

$$D = A \sin \frac{(x - vt)}{\lambda}$$

Where λ is a length. Since $\frac{v}{\lambda}$ has dimension of (1/Time), put $\frac{v}{\lambda} = \frac{1}{T}$

NOTE:

Periodic Wave

$$D = A \sin \left(\frac{2\pi x}{\lambda} - \frac{2\pi t}{T} \right)$$

What is λ ? Plot D as a function of x at $t = 0$.

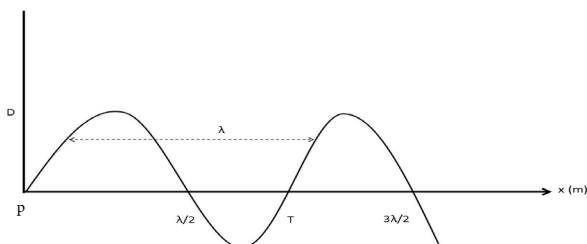

The “wave” function repeats every λ meters so

$$\lambda = \text{wavelength}$$

As before, T is the period, Plot D at x = 0, D repeats every T seconds.

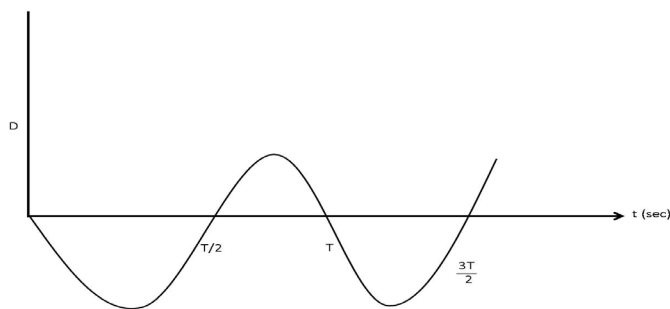

How far will D travel in time $\frac{T}{4}$

$$t = \frac{T}{4} \quad D = A \sin\left(\frac{2\Pi x}{\lambda} - \frac{\Pi}{2}\right)$$

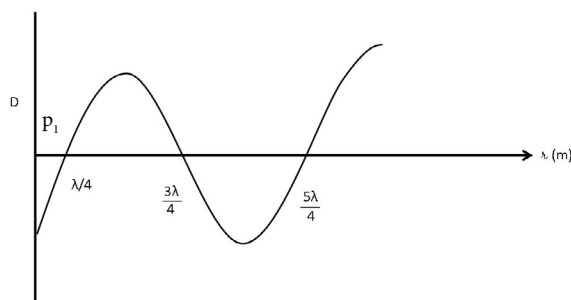

Note: P has travelled to the right by $\frac{\lambda}{4}$ meters so

$$\text{Speed} = \frac{\lambda/4}{T/4} = \frac{\lambda}{T}$$

Velocity $\underline{V} = \frac{\lambda}{T} \hat{x} = \lambda f \hat{x}$

This makes sense because λ is distance moved in one period and the frequency f is the number of periods in 1sec, so distance travelled in 1sec is λf .

EXERCISE: Take $D = A \sin\left(\frac{2\Pi x}{\lambda} + \frac{2\Pi t}{T}\right)$ and convince yourself that in time $\frac{T}{4}$ D moves TO THE LEFT by $\frac{\lambda}{4}$ so velocity

$$\underline{V} = -\lambda f \hat{x}$$

Note

Two kinds of periodic waves:

If $\underline{A} \parallel \hat{x}$ Longitudinal

If $\underline{A} \perp \hat{x}$ Transverse

Longitudinal: Variation of D along direction of propagation

Transverse: Variation of D perpendicular to direction of propagation.

Next, introduce a phase angle \emptyset and we get $D = A \text{Sin}\left(\frac{2\pi x}{\lambda} - \frac{2\pi t}{T} + \emptyset\right)$ as the most general periodic wave. Note that 2π has been put in, as we know repeat angle for *Sin*. If you put $\emptyset = \pi$ you recover the Equation in some books.

$$D = A \text{Sin}\left(\frac{2\pi t}{T} - \frac{2\pi x}{\lambda}\right)$$

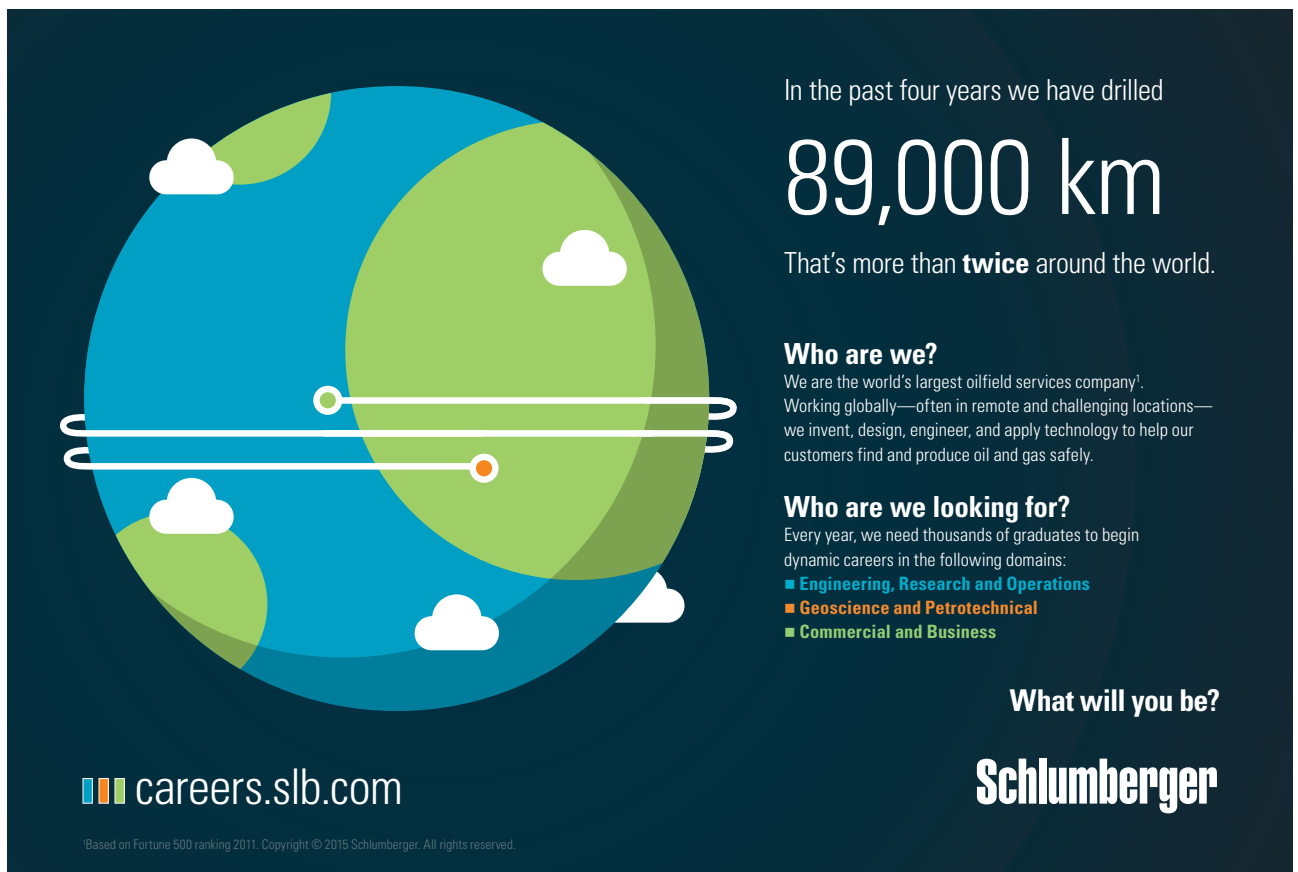

In the past four years we have drilled

89,000 km

That's more than **twice** around the world.

Who are we?
We are the world's largest oilfield services company'. Working globally—often in remote and challenging locations—we invent, design, engineer, and apply technology to help our customers find and produce oil and gas safely.

Who are we looking for?
Every year, we need thousands of graduates to begin dynamic careers in the following domains:

- Engineering, Research and Operations
- Geoscience and Petrotechnical
- Commercial and Business

What will you be?

Schlumberger

careers.slb.com

Based on Fortune 500 ranking 2011. Copyright © 2015 Schlumberger. All rights reserved.

As shown

$$\lambda = \text{Repeat Distance} = \text{wavelength}$$

$$T = \text{period}, \frac{1}{T} = f \text{ (frequency)}$$

$$\text{And } v = \lambda f$$

$$\text{Next, define } k = \frac{2\pi}{\lambda} \text{ (wave vector)}$$

$$\omega = 2\pi f \text{ (angular frequency)}$$

$$\omega = vk$$

And we can write $D = A \sin(kx - \omega t + \phi)$ for any periodic wave traveling a long +ive x -axis with velocity $\vec{v} = \frac{\omega}{k} \hat{x}$

Similarly, $D = A \sin(kx + \omega t + \phi)$ is any periodic wave along -ive x -axis with

$$\vec{v} = -\frac{\omega}{k} \hat{x}$$

4.2 Speed Of Transverse Pulse On A Stretched String, Periodic Wave, Energy Transport

We now know that we can describe a transverse periodic wave of wavelength λ and a frequency f by the equation $y = A \sin(kx - \omega t)$ with $k = \frac{2\pi}{\lambda}$ and $\omega = 2\pi f$ while $A \perp \hat{x}$ with $\omega = vk$ [same as $v = \lambda f$]

To generate a “pulse” we need to sum up many, many periodic waves with different wavelengths, frequencies and amplitudes. Experimentally, all we need is to take a string of length L and mass m tie its one end, pass the other over a pulley and hang a mass M .

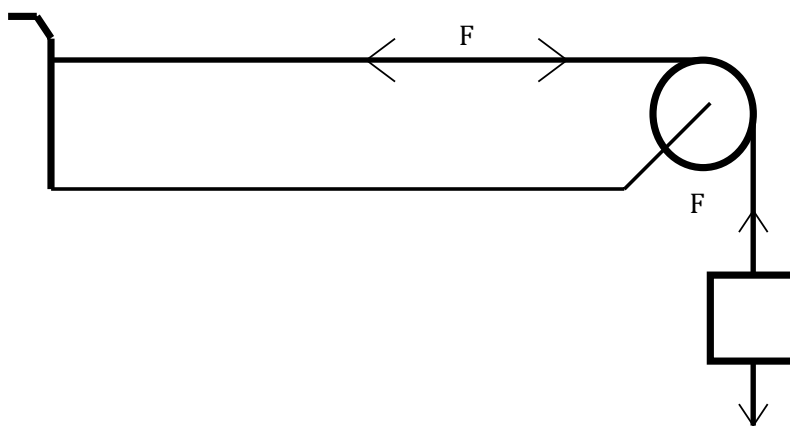

We define linear density $\mu = \frac{m}{L}$

The string will develop tension $F=(Mg)$ everywhere. We will make the string very long, so we do not need to worry about what happens at the ends as of yet. If we “tweak” it, we can observe a pulse such as shown below traveling along it.

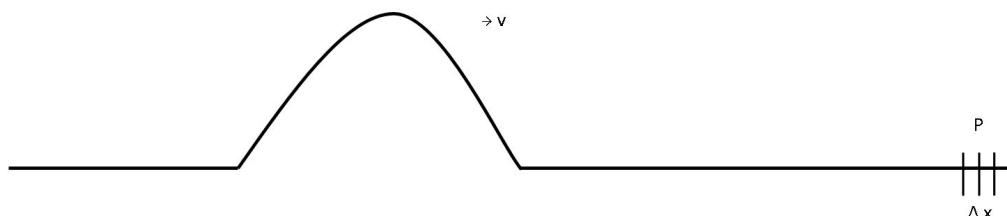

We will keep the amplitude small. Let us concentrate on a small piece of length Δx and ask what happens when the pulse comes along. As is clear Δx is lying there minding its own business when the pulse arrives and Δx must travel on a curved path to participate in the passage of the pulse. Indeed we can imagine that Δx is carried around a circle of radius R at speed v .

American online

LIGS University

is currently enrolling in the
Interactive Online **BBA, MBA, MSc,**
DBA and PhD programs:

- ▶ enroll **by September 30th, 2014** and
- ▶ **save up to 16%** on the tuition!
- ▶ pay in 10 installments / 2 years
- ▶ Interactive **Online** education
- ▶ visit www.ligsuniversity.com to find out more!

Note: LIGS University is not accredited by any nationally recognized accrediting agency listed by the US Secretary of Education. More info [here](http://www.ligsuniversity.com).





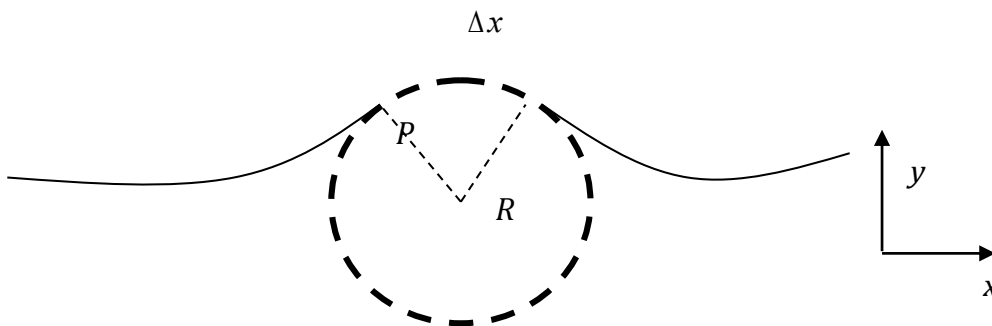

Since Δx has a mass of $\mu\Delta x$ it needs a force $\underline{F_c} = -\frac{\Delta x v^2 \mu}{R} \hat{r}$ to go around the circle. The question is, what force is available to make this happen. Let us make Δx big and draw forces:

Immediately, we see that the net force Along x (parallel to string) is zero. But the y -components due to the tension add

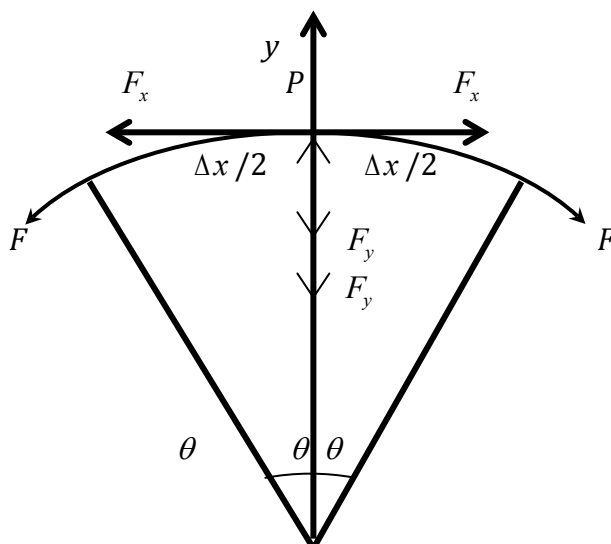

So available force at P is $\underline{F_A} = -2F_y \hat{y}$

$$\begin{aligned}
 &= -2F \sin \theta \hat{y} \\
 &\cong -2F \theta \hat{y} \quad \text{Since } \theta \ll 1. \\
 &= -2F \frac{\Delta x}{2R} \hat{y} \quad \theta = \frac{\Delta x}{2R} \\
 &= -F \frac{\Delta x}{R} \hat{y}
 \end{aligned}$$

While at P the needed \vec{F}_c is $-\frac{\mu\Delta x v^2}{R} \hat{y}$. If $\vec{F}_A = \vec{F}_c$ Δx can happily participate in the pulse. That is, we must require $\frac{F\Delta x}{R} = \frac{\mu\Delta x v^2}{R}$. So $v = \sqrt{\frac{F}{\mu}}$ is the speed of a small amplitude pulse in a string which has a tension F in it and a linear density (mass per unit length) of $\mu \text{ kg/m}$. It seems reasonable that for a periodic wave on our string we can write

$$y = A \sin(kx - \omega t)$$

$$\omega = vk$$

$$v = \sqrt{\frac{F}{\mu}}$$

Provided that we keep $A \ll \lambda$ so all angles are small [we needed $\theta \ll 1$ in our proof].

[Note that when $\Theta \ll 1$, $\sin \Theta \approx \Theta$]

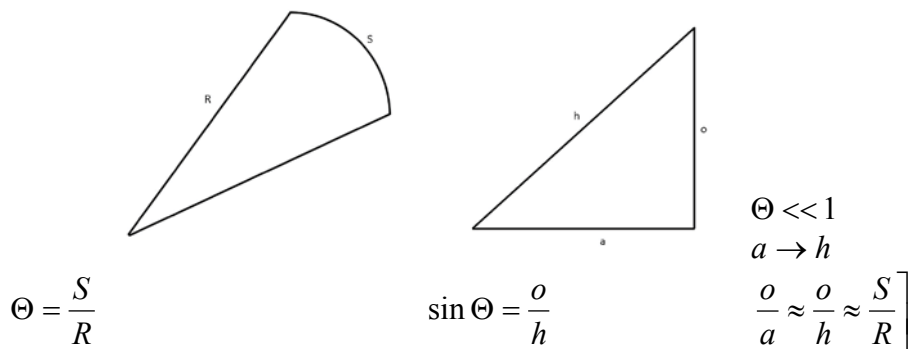

4.3 Energy transport by sine wave on string

Every point on the string has a y coordinate which varies as $y = A \sin \omega t$. This is like linear harmonic motion so every point has a transverse velocity

$$v_y = A\omega \cos \omega t$$

A unit length of string will therefore have a kinetic energy $K = \frac{1}{2} \mu A^2 \omega^2 \cos^2 \omega t$

Whose maximum value (which is equal to total energy, KIN + POTL)* will be $K_{\max} = \frac{1}{2} \mu A^2 \omega^2$ wave travels by $v \text{ m/s}$ so energy transport per second $\eta = \frac{1}{2} \mu A^2 \omega^2 v$

Since $F = \mu v^2$ we can also write $\eta = \frac{1}{2} A^2 \omega^2 \frac{F}{v}$

*Treat A unit length of string as a “spring-mass” oscillator with spring constant k_0 .

$$\text{Kinetic Energy} \quad K = \frac{1}{2} \mu A^2 \omega^2 \cos^2 \omega t$$

$$\text{Potential Energy} \quad u = \frac{1}{2} k_0 A^2 \sin^2 \omega t$$

$$\text{But } \omega = \sqrt{\frac{k_0}{\mu}}$$

$$\text{So } u = \frac{1}{2} \mu A^2 \omega^2 \sin^2 \omega t$$

Next averaged overtime $\langle \sin^2 \omega t \rangle = \langle \cos^2 \omega t \rangle$

$$= \frac{1}{2}$$

$$\begin{aligned} \text{So } \langle K \rangle + \langle u \rangle &= \left(\frac{1}{4} + \frac{1}{4} \right) \mu A^2 \omega^2 \\ &= \frac{1}{2} \mu A^2 \omega^2 \end{aligned}$$

[Of course, $\sin^2 \omega t + \cos^2 \omega t = 1$ so it is not surprising that $\langle K \rangle + \langle u \rangle = K_{\max} = u_{\max}$ since our oscillator has no friction, total energy is CONSTANT!]

.....Alcatel-Lucent 

www.alcatel-lucent.com/careers

What if you could build your future and create the future?

One generation's transformation is the next's status quo. In the near future, people may soon think it's strange that devices ever had to be “plugged in.” To obtain that status, there needs to be “The Shift”.



4.4 Standing Waves/String Instruments

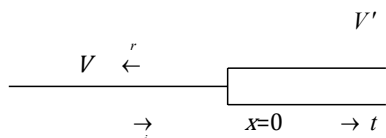

If two strings meet at $x=0$, then an **incident** wave

$$Y_i = A_i \sin(\kappa x - \omega t)$$

Where $\frac{\omega}{k} = v$

Will, on arriving at $x=0$, give rise to two waves

Reflected $Y_r = A_r \sin(\kappa x + \omega t)$ and **Transmitted** $Y_t = A_t \sin(\kappa' x - \omega t)$

Where $\frac{\omega}{k} = v$

Note: FREQUENCY DOES NOT CHANGE – Why?

Further,

$$\frac{A_r}{A_i} = \frac{v - v'}{v + v'}$$

$$\frac{A_t}{A_i} = \frac{2v'}{v + v'}$$

Interesting situation arises if $v' \rightarrow 0$, that is, string on the right is like a ‘wall’ or equivalently the end of the string on left is “fixed” at $x=0$. In that case

$$\frac{A_r}{A_i} = 1 ; \text{ So, } Y_i = A_i \sin(\kappa x - \omega t)$$

$$Y_r = A_i \sin(\kappa x + \omega t)$$

Now we have two waves on the string at the same time and to handle it, we use the principle of SUPERPOSITION. Since a wave is just a disturbance or a deviation, it is perfectly legitimate to have many simultaneous disturbances at the same point in space. The net effect is that one must algebraically add all of the disturbances

$D = \sum D_i$, where

$$D_i = A_i \sin(\kappa_i x \mp \omega_i t)$$

and $\frac{\omega_i}{\kappa_i} = v$

So, that total wave will be

$$Y = Y_i + Y_r$$

$$= A_i \sin(\kappa x - \omega t) + A_r \sin(\kappa x - \omega t)$$

using the trigonometric identity $\sin(\theta_1 \pm \theta_2) = \sin \theta_1 \cos \theta_2 \pm \cos \theta_1 \sin \theta_2$

we get

$$y = 2 A_i \sin \kappa x \cos \omega t$$

$$= 2 A_i \sin \frac{2\pi x}{\lambda} \cos \omega t$$

and you see that $y=0$ if $x = 0, \frac{-\lambda}{2}, -\lambda, \frac{-3\lambda}{2}, etc.$

That is, there is NO MOTION AT ALL AT SOME POINTS OF THE STRING. These points are called NODES.

In between two nodes, that is, at

$$x = \frac{-\lambda}{4}, \frac{-3\lambda}{4}, \frac{5\lambda}{4}, etc.$$

The string vibrates with twice the amplitude. These points are termed ANTINODES.

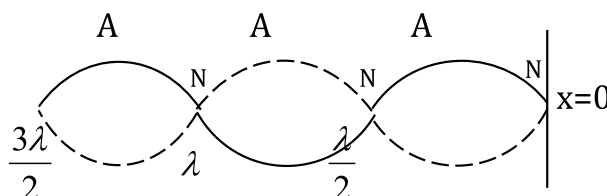

This is how the string will look where the i and r waves were both present.

The case of most interest arises when the wire is fixed at both ends (as in musical instruments).

Because of what we learned above, there must be a node at either end and there must be a node every $\frac{\lambda}{2}$ as well. This requires that the wire can vibrate in only certain specific MODES such as:

FIRST HARMONIC, $n= 1$

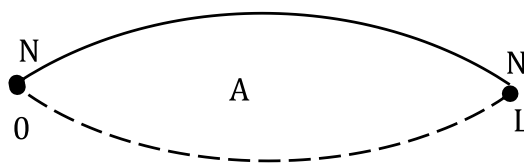

$$\frac{\lambda_1}{2} = L$$

SECOND HARMONIC, $n=2$

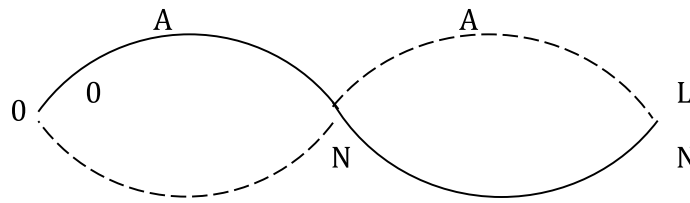

$$2\left(\frac{\lambda_2}{2}\right) = L$$

THIRD HARMONIC, $n=3$

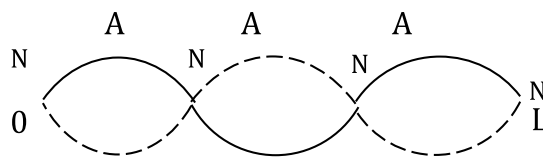

$$3\left(\frac{\lambda_3}{2}\right) = L$$



**Join the best at
the Maastricht University
School of Business and
Economics!**

Top master's programmes

- 33rd place Financial Times worldwide ranking: MSc International Business
- 1st place: MSc International Business
- 1st place: MSc Financial Economics
- 2nd place: MSc Management of Learning
- 2nd place: MSc Economics
- 2nd place: MSc Econometrics and Operations Research
- 2nd place: MSc Global Supply Chain Management and Change

Sources: Keuzegids Master ranking 2013; Elsevier 'Beste Studies' ranking 2012; Financial Times Global Masters in Management ranking 2012

Maastricht University is the best specialist university in the Netherlands
(Elsevier)

Visit us and find out why we are the best!
Master's Open Day: 22 February 2014

www.mastersopenday.nl



That is, the wavelengths λ_n of the modes must obey

$$\frac{n\lambda_n}{2} = L$$

or

$$\lambda_n = \frac{2L}{n}$$

$n=1,2,3$, etc. or in words, only those modes can occur in which there is an integer number of “half wavelengths” fitting on the wire.

The modes with $n \geq 2$ are called *Harmonics* of the fundamental mode. That word comes from musical ethos.

Next,

$$v = \sqrt{\frac{F}{\mu}}$$

So the frequencies of these modes will

$$\begin{aligned} f_n &= \frac{v}{\lambda_n} \\ &= \frac{n}{2L} \sqrt{\frac{F}{\mu}} \end{aligned}$$

And this Equation describes all string instruments. To be precise:

- 1) When you tighten a string, the note goes “up” because v increases for a given λ (length).
- 2) The shorter the string the higher the note.
- 3) If you look inside a piano you will notice that the lowest notes have very thick strings. Here, a high μ is used to reduce v and thereby lower f .
- 4) If you are “playing” a single string on the sitar or guitar you must move close to the lower end to get a higher note as this reduces the length of the string where you are plucking.
- 5) If you pull the string sideways you can get subtle variations in the frequency. This is most often used by sitar players. It works because you can vary the tension by small amounts. Such subtle variations are also accomplished by imaginative bowing of the violin/viola/bass/fiddle.

4.5 Appendix

PHASE CHANGES ON REFLECTION

When

$$v' = 0$$

$$Y_i = A_i \sin(\kappa x - \omega t) \quad \frac{A_r}{A_i} = 1$$

$$Y_r = A_i \sin(\kappa x + \omega t)$$

Note that reflected wave is “born” when incident wave arrives at $x=0$. We can compare the phases at

$$x = 0$$

$$Y_i = A_i \sin(-\omega t)$$

$$= -A_i \sin \omega t$$

$$= +A_i \sin(\omega t + \pi)$$

$$Y_r = A_i \sin \omega t$$

So you see that during reflection at a fixed end there is a phase change of π . If a “crest” arrives, it leaves as a “trough” and vice versa.

The other extreme case

If $v' \gg v$

$$\frac{A_r}{A_i} \cong -1, \frac{A_t}{A_i} = 2.$$

Since energy transport is $\eta = \frac{1}{2} A^2 \omega^2 \frac{F}{v}$ and $v' \gg v$, η_r is very small. That is very little energy is transmitted into the wire on the right.

For wire on the left at $x=0$, $A_r = -A_i$ hence

$$Y_i = -A_i \sin \omega t$$

also

$$Y_r = -A_i \sin \omega t$$

So, no change of phase in this case.

When a crest arrives it leaves as a crest.

Summary

Reflection at a “fixed” end \rightarrow phase change of π .

Reflection at an “open” end \rightarrow No phase change. (We return to this in more detail later).

5 Sound

- There is **NO** sound in vacuum; you need matter to propagate a sound wave.
- SOUND:** Any mechanical wave whose frequency lies between 20Hz and 20,000Hz, that is, $20\text{Hz} \leq f \leq 20\text{kHz}$ (It is called sound because you can hear it!).
- We will work with sound in Gases only-then sound is a purely Longitudinal wave.
- Sound is a longitudinal displacement wave or a longitudinal pressure wave.
- Periodic Sound wave properties

<u>DISPLACEMENT</u>	<u>PRESSURE</u>
<p>Sine wave, $\phi = 0$</p> $S = S_m \sin(\kappa x - \omega t)$ <p>amplitude $S_m \parallel \hat{x}$</p> $\omega = vk$	<p>To write corresponding pressure wave we have to realize that the variation occurs so rapidly that there is no possibility for exchange of heat (DQ) to ensure equilibrium with surroundings, so DQ=0, sound is an <u>adiabatic</u> process: Pressure and Volume satisfy:</p> $P_0 V_0^\gamma = \text{constant.}$ <p>P_0 = ambient pressure</p> $\gamma = \frac{C_p}{C_v}, C_p = \text{sp ht at const } P$ $C_v = \text{sp ht at const } V$ $\gamma_{\text{monoatomic}} = \frac{5}{3}$ $\gamma_{\text{diatomic}} = \frac{7}{5}$ $\rightarrow \phi = \frac{-\pi}{2}$ $P = P_0 - \gamma P_0 S_m \kappa \cos(\kappa x - \omega t)$
<p>Displacement oscillates about zero.</p>	<p>Pressure oscillates about P_0</p> <p>Amp of pressure wave</p> $P_m = \gamma P_0 S_m \kappa$ <p>$P_m \parallel \hat{x}$</p> <p>Pressure is $\frac{\pi}{2}$ out of phase with displacement where S is max. (P-P₀)=0!</p>

Displacement wave \rightarrow Pressure wave

If the displacement of the gas atoms is a function of x then near a point where $S = 0$ either the gas is **expanding**

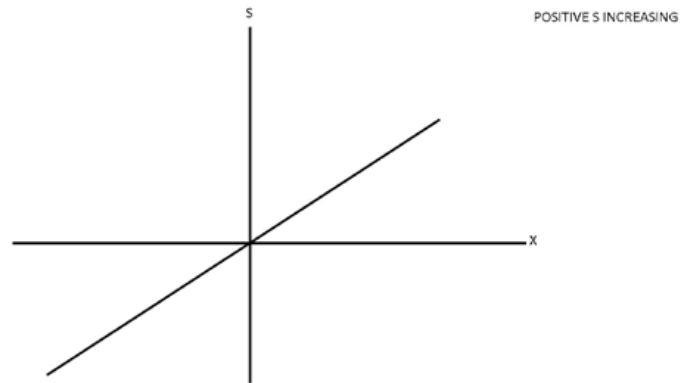

> Apply now

REDEFINE YOUR FUTURE
**AXA GLOBAL GRADUATE
PROGRAM 2015**

redefining / standards 

agence.cdg. © Photonistop

Or **contracting**

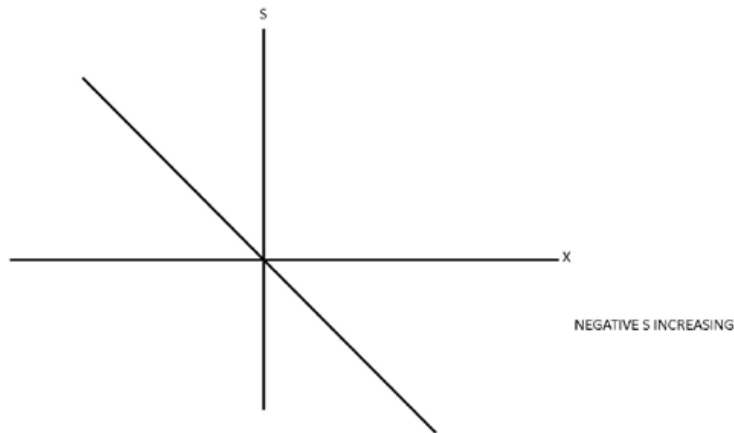

In either case, volume is changing so pressure must change and therefore we must know the relation between these changes to proceed further. The frequencies are higher than 20Hz so all the variations are extremely rapid, heat exchange with surrounding is effectively zero. Sound is an adiabatic process.

5.1 Special note

Detailed interpretation of displacement and pressure curves in a sound wave

Or

Why is pressure variation $\frac{\pi}{2}$ out of phase with displacement as a function of position?

The curves are (at $t = 0$)

Displacement

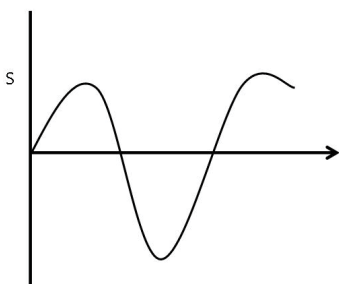

Pressure

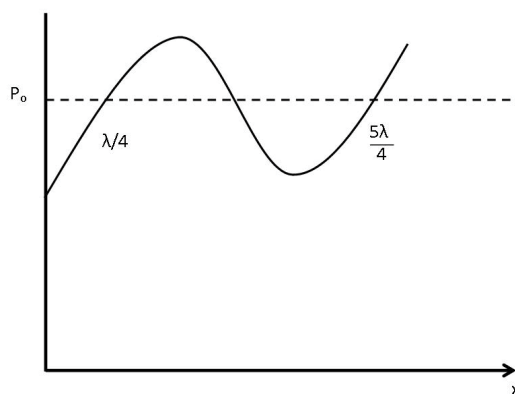

$$S = S_m \sin kx$$

$$P = P_0 - P_m \cos kx$$

Near $x = 0$, Displacements look like

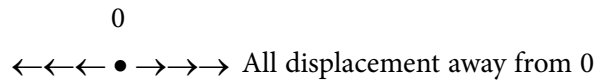

That is displacements of particles increase rapidly as you go away from $x = 0$. Consequently, gas is in **expansion** that is why pressure is at **MINIMUM**.

Near $x = \frac{\lambda}{4}$, Displacements look like

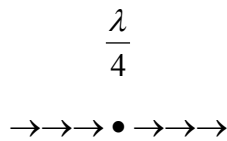

That is, **all** the displacements are nearly equal so there is little change in volume and hence P is at its equilibrium value. Deviation from $\equiv m$ is **zero**.

Near $x = \frac{\lambda}{2}$, Displacements look like

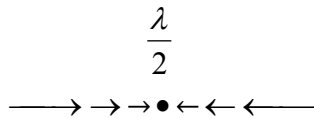

Displacements are toward $\frac{\lambda}{2}$ and increase as you go away from $\frac{\lambda}{2}$ so here gas is in contraction and that is why pressure is at a **MAXIMUM**.

CRUCIAL Pt. is that change of volume and hence change of pressure happens only if displacement everywhere is not the same.

Speed of sound in a gas

$$v = \sqrt{\frac{\gamma P_0}{\rho_0}}$$

$\rho_0 =$ ambient density

since $P_0 V_0 = N k_B T$

$$[k_B = 1.383 \times 10^{-23} \text{ J / K}]$$

If gas particles have mass m , we can write

$$P_0 = \frac{Nm}{V_0} \frac{k_B T}{m}, \text{ or } \frac{P_0}{\rho_0} = \frac{k_B T}{m}$$

$$v = \sqrt{\frac{\gamma k_B T}{m}} = \sqrt{\gamma} \frac{v_{rms}}{\sqrt{3}} \quad [T \text{ in Kelvin Scale}]$$

5.2 Intensity of Sound – Experiment

Sound wave, of course, transports energy and we define the intensity as energy transport per unit area per unit time.

Intensity (I) MT^{-3} $Watt/m^2$ Scalar

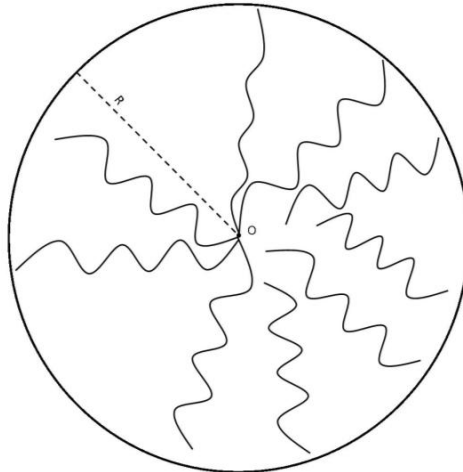

BI NORWEGIAN BUSINESS SCHOOL

EFMD EQUIS ACCREDITED

Empowering People. Improving Business.

BI Norwegian Business School is one of Europe’s largest business schools welcoming more than 20,000 students. Our programmes provide a stimulating and multi-cultural learning environment with an international outlook ultimately providing students with professional skills to meet the increasing needs of businesses.

BI offers four different two-year, full-time Master of Science (MSc) programmes that are taught entirely in English and have been designed to provide professional skills to meet the increasing need of businesses. The MSc programmes provide a stimulating and multi-cultural learning environment to give you the best platform to launch into your career.

- MSc in Business
- MSc in Financial Economics
- MSc in Strategic Marketing Management
- MSc in Leadership and Organisational Psychology

www.bi.edu/master



To calculate I we begin by putting a point source of sound at the origin. Let it emit P_w watts (Joules/sec) of power. The wave spreads equally in all directions and after travelling a distance R from O is spread evenly on the surface of a sphere of radius R . So

$$I = \frac{P_w}{4\pi R^2}$$

As we move away from the source the intensity will reduce as the square of the distance from the source.

Example: Let $P_w = 126 \text{ Watts}$

$$(4\pi \cong 12.6)$$

We can construct the table

R (m)	I (Watts/m ²)
1	10
10	10 ⁻¹
10 ²	10 ⁻³
10 ³	10 ⁻⁵
10 ⁴	10 ⁻⁷
10 ⁵	10 ⁻⁹
10 ⁶	10 ⁻¹¹
3.2 x 10 ⁶	10 ⁻¹²

The numbers in the table look awfully small but it is useful to know that the human ear can detect $10^{-12} \text{ Watt / m}^2$.

Animals are even more sensitive. Incidentally, your ear “drum” is essentially a disk of radius 1cm so the quietest sound delivers only 3×10^{-18} Joules/sec. In the sequel, we will calculate the amplitude of this wave.

5.3 Level of Sound – Decibel Scale

It was Alexander Graham Bell (the inventor of the telephone) who discovered that the human ear is **not** a linear detector. In fact, if I goes from $10^{-9} \text{ Watt / m}^2$ to $10^{-6} \text{ Watt / m}^2$ we will claim that intensity has just increased by a factor of 2. This has led to the convention that instead of speaking of intensity of sound we speak of the sound level β defined by the equation

$$\beta = (10dB) \log_{10} \frac{I}{I_0}$$

β (dB)	I/I_0	I (W/m^2)
0	1	10^{-12}
10	10^1	10^{-11}
20	10^2	10^{-10}
30	10^3	10^{-9}
40	10^4	10^{-8}
50	10^5	10^{-7}
60	10^6	10^{-6}

Where dB is the abbreviation for Decibel (in honor of A.G.) and $I_0 = 10^{-12}$ so for the quietest sound $\frac{I}{I_0} = 1, \beta = 0$.

Again, let us make a table and you see as I goes from $10^{-9} \text{ Watt} / m^2$ to $10^{-6} \text{ Watt} / m^2$, β increases only by a factor of 2.

Further, the logarithmic variation implies that, $63\text{dB} = 2 \times 10^{-6} \text{ Watt} / m^2$, and $66\text{dB} = 4 \times 10^{-6} \text{ Watt} / m^2$ Incidentally 120dB represents the threshold of pain!

Need help with your dissertation?

Get in-depth feedback & advice from experts in your topic area. Find out what you can do to improve the quality of your dissertation!

Get Help Now



Go to www.helpmyassignment.co.uk for more info



Click on the ad to read more

5.4 Intensity Of Sound – Periodic Wave

Imagine that the wave is traveling with velocity v through a tube of cross-section A .

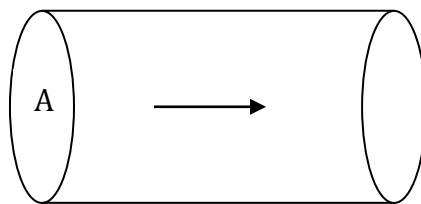

Since $S = S_m \sin(\kappa x - \omega t)$ the particle velocity is $V_p = S_m \omega \cos(\kappa x - \omega t)$ and kinetic energy per unit volume is $K \cdot E = \frac{1}{2} \rho_0 S_m^2 \omega^2$. Volume of wave traveling past every cross-section will be $A v$ in one second. (Energy transport per second through area A) $= \frac{1}{2} A \rho_0 S_m^2 \omega^2 v$

Intensity $I =$ energy transport per second per m^2

$$I = \frac{1}{2} \rho_0 S_m^2 \omega^2 v \quad \left[\rho_0 = \frac{\gamma P_0}{v^2} \right]$$

$$= \frac{1}{2} \gamma P_0 S_m^2 \frac{\omega^2}{v}$$

Please compare this with energy transport per second on wire $\langle P \rangle = \frac{1}{2} A^2 \frac{\omega^2}{v} \cdot F$

Amplitude of displacement wave for I_0 ($\omega = 10^3 \text{ rad/s}$, $\gamma = 1.4$, $P_0 = 10^5 \text{ N/m}^2$),

$$10^{-12} = \frac{1}{2} \times 1.4 \times 10^5 \times \frac{S_m^2 \times 10^6}{340}$$

$$S_m \cong 10^{-10} \text{ m}$$

Roughly equal to diameter of hydrogen atom. REMARKABLE!!!*

*Your ear can discern motion of air molecules whose displacement is equal to the diameter of a hydrogen atom.

5.5 Sound-wind instruments

In a wind instrument sound is generated by causing vibrations in a column of air contained in a tube which may be open at both ends or open at one end and closed at the other. In analogy with the case of the wire of finite length we again set up a series of MODES of vibration in the air column. So, we begin by recalling that for a wire (transverse displacement wave) when reflection occurs at a fixed end there is a phase change of π so that wire of length L , fixed at both ends can have only those modes for which the wavelength λ_n satisfies the Equation:

$$n \left(\frac{\lambda_n}{2} \right) = L \quad (1)$$

or frequencies

$$f_n = \frac{n}{2L} \sqrt{\frac{F}{\mu}} \quad (2)$$

Before we use these Equations to write down the modes in an air column. We should ask what happens when the end is not fixed. Recall that if we send an incident wave

$$y = A_i \sin(kx - \omega t)$$

$$\omega = vk$$

to a point at $x=0$ where v changes to v' we will get a reflected wave

$$y_r = A_r \sin(kx + \omega t) \text{ and a transmitted wave } y_t = A_t \sin(k'x - \omega t)$$

$$\omega = v'k'$$

Note again ω does not change!

Also

$$\frac{A_r}{A_i} = \frac{v - v'}{v + v'}, \quad \frac{A_t}{A_i} = \frac{2v'}{v + v'}$$

To simulate an open end we go to the other limit $\mu' \rightarrow 0, v' > v$. Then $\frac{A_r}{A_i} = -1, A_t = 2A_i$

Brain power

By 2020, wind could provide one-tenth of our planet's electricity needs. Already today, SKF's innovative know-how is crucial to running a large proportion of the world's wind turbines.

Up to 25 % of the generating costs relate to maintenance. These can be reduced dramatically thanks to our systems for on-line condition monitoring and automatic lubrication. We help make it more economical to create cleaner, cheaper energy out of thin air.

By sharing our experience, expertise, and creativity, industries can boost performance beyond expectations. Therefore we need the best employees who can meet this challenge!

The Power of Knowledge Engineering

Plug into The Power of Knowledge Engineering.
Visit us at www.skf.com/knowledge

SKF

N.B. It may appear that A_r being $2A_i$ transmitted power will be large but that is not true, because on a wire $\langle P \rangle = \frac{1}{2} A^2 \omega^2 \frac{F}{v}$

Since $v' \rightarrow \infty, \langle P_t \rangle \rightarrow 0$.

$$y_i = A_i \sin(kx - \omega t)$$

So now on the wire at left we have $\frac{A_r}{A_i} = -1$

$$y_r = -A_i \sin(kx + \omega t)$$

We compare phases at $x=0$

$$y_i = A_i \sin(-\omega t) = -A_i \sin \omega t$$

$$y_r = -A_i \sin \omega t$$

so now there is **NO** phase change on reflection-incoming crest gives rise to outgoing crest.

By superposition,

$y = y_i + y_r = 2A_i \cos kx \cos \omega t$ And this is also **NOT** a traveling wave. Indeed, I) now we have an **ANTINODE** at $x=0$

II) The first node is at $\frac{\lambda}{4}$

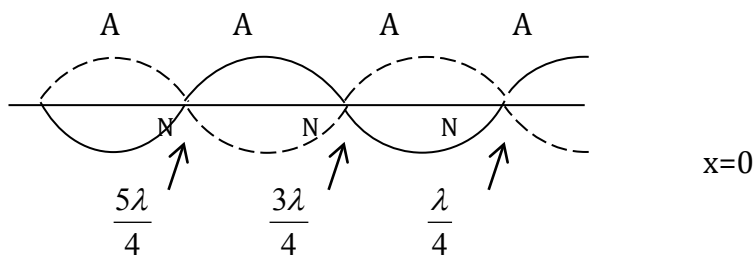

So for an “open” end we also get stationary wave but now the end is an antinode.

The above applies to displacement waves and since sound can be thought of as a displacement or a pressure wave we have the rules

Displacement ($\phi = 0$)		Pressure ($\phi = -\pi/2$)
Open end	ANTINODE	NODE
Closed end	NODE	ANTINODE

Now we can draw the nodes for vibrations in a column of air in a tube of length L .

Case I: Both ends open

DISPLACEMENT

1ST HARMONIC

$$\frac{\lambda_1}{2} = L$$

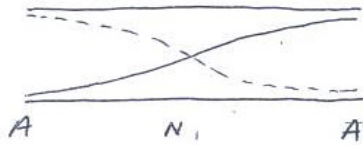

2nd HARMONIC

$$\frac{2\lambda_2}{2} = L$$



3rd HARMONIC

$$\frac{3\lambda_3}{2} = L$$

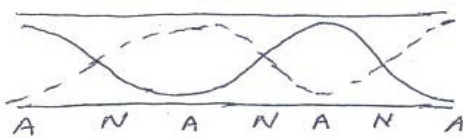

PRESSURE

$$\frac{\lambda_1}{2} = L$$

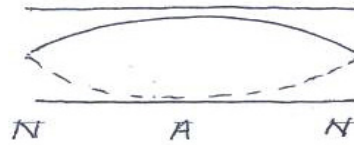

$$\frac{2\lambda_2}{2} = L$$

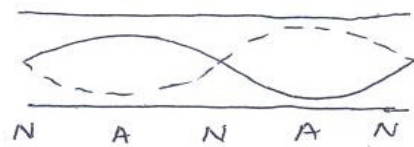

$$\frac{3\lambda_3}{2} = L$$

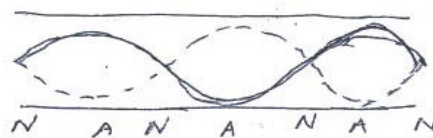

That is $n \left(\frac{\lambda_n}{2} \right) = L$

$n = 1, 2, 3, \dots$

So the frequencies go as 1, 2, 3, ...

Case II: One end open, one closed

DISPLACEMENT

1st HARMONIC

$$\frac{\lambda_1}{4} = L$$

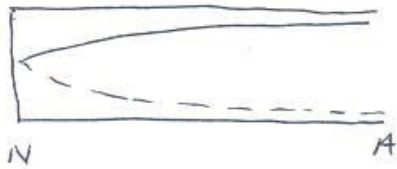
3rd HARMONIC

$$\frac{3\lambda_2}{4} = L$$

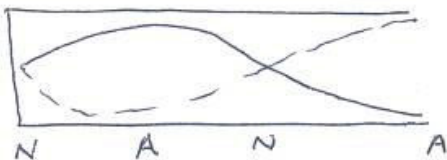
5th HARMONIC

$$\frac{5\lambda_3}{4} = L$$

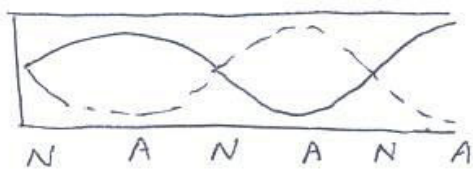

PRESSURE

$$\frac{\lambda_1}{4} = L$$

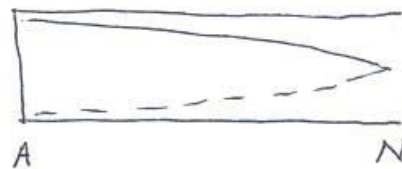

$$\frac{3\lambda_2}{4} = L$$

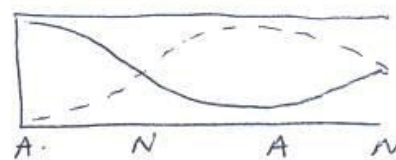

$$\frac{5\lambda_3}{4} = L$$

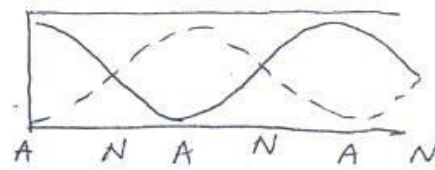

So the modes obey

$$(2n-1)\frac{\lambda_n}{4} = L$$

$$n = 1, 2, 3, \dots$$

$$f_n = \frac{(2n-1)}{4L} \sqrt{\frac{rP_0}{\rho_0}}$$

and in this case the frequencies go as 1,3,5...(first, third, fifth harmonic)

5.6 Sound-doppler effect

Definition: If either the detector (D) or the source (S) of a wave moves along the line joining them, the perceived frequency is not equal to the emitted frequency.

Consider: D and S and sound waves in air

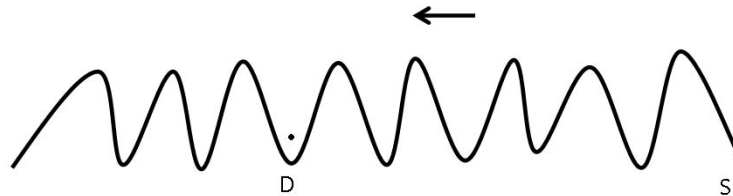

Source and Detector both at rest

S emits wave of frequency f

D perceives wave of frequency f

That is, f undulations pass by D every second and wave goes past D by the amount $V_s = \sqrt{\frac{\gamma P_0}{\rho_0}}$ every second.

What do you want to do?

No matter what you want out of your future career, an employer with a broad range of operations in a load of countries will always be the ticket. Working within the Volvo Group means more than 100,000 friends and colleagues in more than 185 countries all over the world. We offer graduates great career opportunities – check out the Career section at our web site www.volvogroup.com. We look forward to getting to know you!

VOLVO
 AB Volvo (publ)
www.volvogroup.com

VOLVO TRUCKS | RENAULT TRUCKS | MACK TRUCKS | VOLVO BUSES | VOLVO CONSTRUCTION EQUIPMENT | VOLVO PENTA | VOLVO AERO | VOLVO IT
 VOLVO FINANCIAL SERVICES | VOLVO 3P | VOLVO POWERTRAIN | VOLVO PARTS | VOLVO TECHNOLOGY | VOLVO LOGISTICS | BUSINESS AREA ASIA



Case I: D Moves Toward

D Moves **toward** S at V_D m/sec.

Now D will pick up f' undulations per second which lie in the distance $(V_S + V_D)$

$$f \propto V_S$$

$$f' \propto (V_S + V_D)$$

[\propto = proportional to]

So

$$\frac{f'}{f} = \frac{V_S + V_D}{V_S} \quad \text{Toward}$$

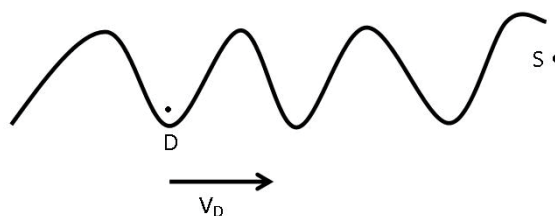

Case II: D Moves Away

If D moves **away** from S by V_D meters/sec all the undulations lying within V_D are no longer counted by it. Hence

$$\frac{f'}{f} = \frac{V_S - V_D}{V_S} \quad \text{Away}$$

So difference between perceived frequency f' and emitted frequency f is essentially a matter of “counting” number of “waves” passing by D every second.

To summarize, when D moves

$$\frac{f'}{f} = \left(1 \pm \frac{V_D}{V_S} \right) \begin{matrix} + & \text{Toward} \\ - & \text{Away} \end{matrix}$$

Case III: S-Moves

Note: Speed of wave is controlled by air, if air is stationary speed is

$$V_S = \sqrt{\frac{\gamma P_0}{\rho_0}}$$

even if source moves.

S-Stationary:

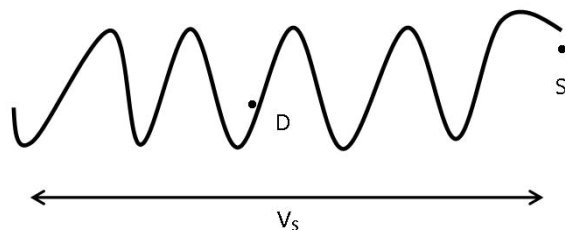

Wave leaving S at $t = 0$ reaches V_s away in 1 sec. All the waves fit within V_s . Hence wavelength

$$\lambda \propto V_s$$

If source moves toward D by amount V_{s0} in one sec.

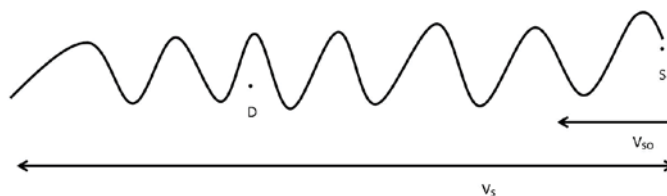

gaiTeye
Challenge the way we run

EXPERIENCE THE POWER OF FULL ENGAGEMENT...

**RUN FASTER.
RUN LONGER..
RUN EASIER...**

**READ MORE & PRE-ORDER TODAY
WWW.GAITEYE.COM**



The wave is now “squeezed” into the distance $(V_s - V_{s0})$

So

$$\lambda' \propto (V_s - V_{s0})$$

Hence

$$\frac{\lambda'}{\lambda} = \frac{V_s - V_{s0}}{V_s}$$

But

$$\lambda' f' = \lambda f = V_s$$

So perceived frequency

$$\frac{f'}{f} = \frac{\lambda}{\lambda'} = \frac{1}{1 - \frac{V_{s0}}{V_s}} \quad \text{Toward}$$

If source moves away from D wave gets stretched to occupy $(V_s + V_{s0})$

$$\frac{\lambda'}{\lambda} = \frac{V_s + V_{s0}}{V_s}$$

$$\frac{f'}{f} = \frac{1}{1 + \frac{V_{s0}}{V_s}} \quad \text{Away}$$

To summarize, if S moves, perceived frequency is given by

$$\frac{f'}{f} = \frac{1}{1 \pm \frac{V_{s0}}{V_s}} \quad \begin{array}{l} - \text{ Toward} \\ + \text{ Away} \end{array}$$

5.7 Sound waves-beats

What would you hear (detect) if two sound waves of slightly* different frequencies arrived at your ear at the same time. Let us put detector at $x = 0$ and have two waves

$$S_1 = S_m \sin(kx + \omega t)$$

$$\frac{\omega}{k} = V_s = \frac{\omega'}{k'}$$

$$S_2 = S_m \sin(k'x + \omega't)$$

$$x = 0$$

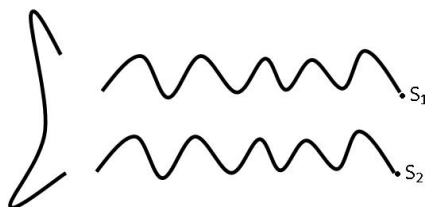

Ear

Superpose S_1 and S_2 at $x = 0$

$$\begin{aligned} S &= S_m (\sin \omega t) + S_m \sin(\omega' t) \\ &= 2S_m \cos\left(\frac{\omega - \omega'}{2} t\right) \cos\left(\frac{\omega + \omega'}{2} t\right) \end{aligned}$$

$$* (\omega - \omega') < \omega \quad [(f' - f) \ll f] \text{ so } \frac{\omega + \omega'}{2} \approx \omega$$

$$S = 2 \sin \cos \left[2\pi \left(\frac{f - f'}{2} \right) t \right] \sin \omega t$$

So you perceive a wave of frequency f whose amplitude varies as

$$\cos \frac{2\pi(f - f')}{2} t$$

$$\text{or at a frequency } \Delta = \left(\frac{f - f'}{2} \right)$$

That is if you plot amplitude as a function of t you get:

Amp.

$$T = \frac{1}{\Delta}$$

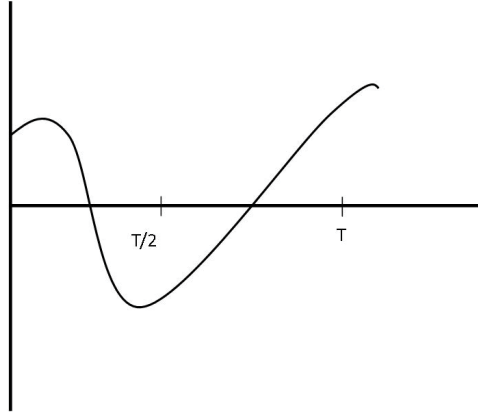

Note that in one period there are two maxima and two zeros so you will detect

$$f_B = |f - f'|$$

as the number of Beats when both sounds arrive together, you hear one frequency, but its amplitude has $|f - f'|$ maxima and $|f - f'|$ zeros every second.

This e-book
is made with
SetaPDF



SETASIGN



PDF components for PHP developers

www.setasign.com



If you strike two bars with frequencies $f = 440\text{Hz}$ and $f' = 445\text{Hz}$ you will hear 440Hz and five zeros/maxima per second.

5.8 Sound waves-interference

What happens if two sound waves start in phase but have traveled different distances before they arrive at the detector? S_1, S_2 are two sources of sound, which emit waves in phase.

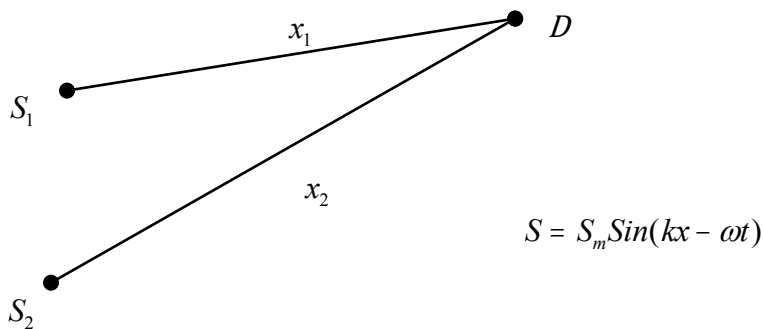

Let us put both phases equal to zero at the starting points. Note: when a wave travels a distance λ its phase must change by 2π . Hence, the wave from S_1 is when it arrives at D will have the phase $\Phi_1 = \frac{2\pi}{\lambda} x_1$.

When this wave arrives at D there is nothing there. However, when the wave from S_2 arrives at D its phase will be $\Phi_2 = \frac{2\pi}{\lambda} x_2$ and since wave from S_1 is already there, the two waves superpose. If $(\Phi_1 - \Phi_2) = 0, 2\pi, 4\pi, 6\pi$ the two waves will be in phase at D and will combine to produce a maximum at D .

We call this constructive interference.

CONDITION FOR MAXIMUM AT D:

$$\begin{aligned}
 (\Phi_1 - \Phi_2) &= 2M\pi \quad M = 0, 1, 2, \dots \\
 \frac{2\pi}{\lambda}(x_1 - x_2) &= 2M\pi \tag{I} \\
 \text{or } (x_1 - x_2) &= M\lambda \quad M = 0, 1, 2, \dots
 \end{aligned}$$

In other words, if the path DIFFERENCE is a whole # of λ 's, the waves which started in phase will again be in phase at D and produce a maximum there.

However, if

$$\begin{aligned}
 (\Phi_1 - \Phi_2) &= \pi, 3\pi, 5\pi\dots \\
 \text{or equivalently} & \\
 (x_1 - x_2) &= (2m + 1) \frac{\lambda}{2}
 \end{aligned}
 \tag{II}$$

with $m=0, 1, 2, \dots$

When the waves meet at D , they will be exactly out of phase 
 And cancel each other.

causing **DESTRUCTIVE INTERFERENCE**

Condition for minimum

$$(x_1 - x_2) = (2m + 1) \frac{\lambda}{2}, m = 0, 1, 2, \dots
 \tag{II}$$

If you keep S_1 and S_2 fixed and move D up and down as shown, $(x_1 - x_2)$ will vary and you will encounter a series of maxima (loud sound) and minima (no sound) as you go alternately from Eq I to Eq II and vice versa.

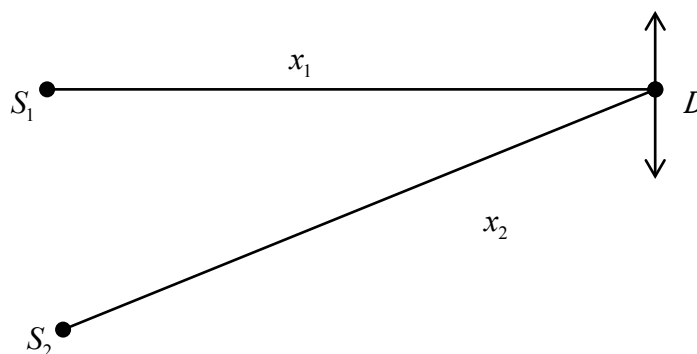

Interesting Case

S_1 and S_2 are separated by $M\lambda$ and D (your ear) moves along line joining S_1 and S_2 .

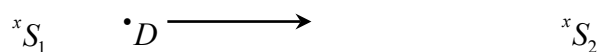

- a) When D is at S_1 :
 - $x_1 = 0$
 - $x_2 = M\lambda$
 - $(x_1 - x_2) = -M\lambda$ **MAX**

b) When D is at Mid-point:

$$x_1 = x_2 = \frac{M\lambda}{2}$$

$$(x_1 - x_2) = 0 \quad \text{MAX}$$

c) When D is at S_2 :

$$x_1 = M\lambda$$

$$x_2 = 0$$

$$(x_1 - x_2) = M\lambda \quad \text{MAX}$$

In all you hear $(2M+1)$ Maxima

In between where will be $2M$ minima

N.B. CRUCIAL QUANTITY IS PATH DIFFERENCE!!!



www.sylvania.com

We do not reinvent
the wheel we reinvent
light.

Fascinating lighting offers an infinite spectrum of possibilities: Innovative technologies and new markets provide both opportunities and challenges. An environment in which your expertise is in high demand. Enjoy the supportive working atmosphere within our global group and benefit from international career paths. Implement sustainable ideas in close cooperation with other specialists and contribute to influencing our future. Come and join us in reinventing light every day.

Light is OSRAM

OSRAM
SYLVANIA



Click on the ad to read more

6 Trig Identity

$\sin A + \sin B$

$$\begin{aligned} &= \sin\left(\frac{A+A+B-B}{2}\right) + \sin\left(\frac{B+B+A-A}{2}\right) \\ &= \sin\left(\frac{A+B}{2}\right)\cos\left(\frac{A-B}{2}\right) + \cos\left(\frac{A+B}{2}\right)\sin\left(\frac{A-B}{2}\right) + \sin\left(\frac{B+A}{2}\right)\cos\left(\frac{B-A}{2}\right) + \cos\left(\frac{B+A}{2}\right)\sin\left(\frac{B-A}{2}\right) \end{aligned}$$

Now

$$\cos\left(\frac{B-A}{2}\right) = \cos\left(\frac{A-B}{2}\right)$$

But

$$\sin\left(\frac{B-A}{2}\right) = -\sin\left(\frac{A-B}{2}\right)$$

Hence

$$\sin A + \sin B = 2\sin\left(\frac{A+B}{2}\right)\cos\left(\frac{A-B}{2}\right)$$

Similarly

$$\cos A + \cos B = 2\cos\left(\frac{A+B}{2}\right)\cos\left(\frac{A-B}{2}\right)$$

So when you superpose

$$y_1 = A\sin(kx_1 - \omega t) \text{ and } y_2 = A\sin(kx_2 - \omega t)$$

You get

$$y = 2A\cos\frac{k(x_1 - x_2)}{2}\sin\left[\frac{k(x_1 + x_2)}{2} - \omega t\right]$$

That is, a wave whose amplitude is controlled by $(x_1 - x_2)$ leading to INTERFERENCE effects.

7 Charge – Electrostatic (Coulomb Force)

So far our economical description of the universe (which we began on the first day of Physics I) has been based on the four fundamental dimensions

Length (L)
Time (T)
Mass (M)
and Temperature (Θ)

and the only fundamental force we have studied is Newton's Universal Gravitational force between two point masses:

$$\underline{F}_G = -\frac{GM_1M_2}{r^2} \hat{r}$$

with

$$G = 6.7 \times 10^{-11} \frac{N \cdot m^2}{(kg)^2}$$

And its application to spherical masses (planetary motion and Earth satellites).

To proceed further, we need to introduce a "5th" player in order to describe our Universe.

————→ CHARGE ←————

The assertion is that in addition to mass (M), matter has another intrinsic property called charge (Q).

QTY	Dimension	Unit	S/V
Charge	Q	Coulomb (C)	Scalar

7.1 Properties of Charge

1. Charge can be **positive** or **negative** (the names were proposed by Ben Franklin and are now universally adopted). This was shown by simple experiments using friction to “charge” rods – glass rod rubbed with silk repels another glass rod similarly charged. However, plastic rod rubbed with fur will attract the rubbed glass rod. You can, of course, “charge” yourself, especially during winter when heated homes are very dry, by walking up and down on a carpet or by “brushing” your hair with a dry comb. In either case sparks are observed when the split charges in the air molecules recombine.
2. Charge is quantized: All charges are integer multiples of a fundamental charge of

$$1.6 \times 10^{-19} \text{ C}$$

That is the charge on any object can be expressed as

$$Q = [N_+ - N_-] \times 1.6 \times 10^{-19} \text{ C}$$

Where N_+ is the number of positive charges and N_- is the number of negative charges. Let us make a table of elementary charges

	Mass	N	Charge
Electron	$9 \times 10^{-31} \text{ Kg}$	$N_- = 1, N_+ = 0$	$-1.6 \times 10^{-19} \text{ C}$
Positron	$9 \times 10^{-31} \text{ Kg}$	$N_- = 0, N_+ = 1$	$+1.6 \times 10^{-19} \text{ C}$
Proton	$1.6 \times 10^{-27} \text{ Kg}$	$N_+ = 1, N_- = 0$	$+1.6 \times 10^{-19} \text{ C}$
Antiproton	$1.6 \times 10^{-27} \text{ Kg}$	$N_- = 1, N_+ = 0$	$-1.6 \times 10^{-19} \text{ C}$
Neutron	$m_N > m_P$	$N_- = N_+$	0
Atom		$N_- = N_+$	0
Na^+ (ion)		Sodium atom with one electron removed	$+1.6 \times 10^{-19} \text{ C}$
Cl^- (ion)		Chlorine atom with one electron added	$-1.6 \times 10^{-19} \text{ C}$
Any Neutral Object		$N_- = N_+$	0

3. Charge is conserved:
The total amount of charge is constant. Charge cannot be created or destroyed. Of course, because of two signs charges can be created in pairs

$$Q = 0 \rightarrow (\text{Electron} + \text{Positron})$$

$$Q = 0 \rightarrow (\text{Proton} + \text{Antiproton})$$

4. Like charges repel, unlike charges attract one another – Coulomb’s law will be discussed in great detail later.

7.2 Charges in Matter

Although full details will be developed later, it is useful at this stage to recognize the following:

Conductors – mostly metals – consist of positive ions which have large masses and are essentially constrained to vibrate about their equilibrium positions and electrons which are relatively free to move throughout the material. [Electrolytes and the cells in biological systems actually have mobile ions suspended in a liquid host.]

Insulators have no mobile electrons. All the electrons are strongly bound to their parent atoms/molecules – NaCl ($Na^+ + Cl^-$) is a common case.

Grounding

The earth is a large conductor and since like charges repel, any charges placed on Earth will spread over its enormous surface and hence connecting any charged conductor (spheres in pictures below) to Earth using a conductor will cause the object to be discharged: Grounded

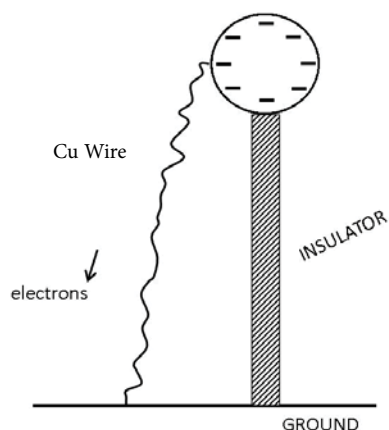

8 Coulomb Force

The force between two point charges located at a distance r from one another bears a striking resemblance to the Gravitational force – it is also proportional to the two charges, it also varies as $\frac{1}{r^2}$ and it also **acts along the line joining Q_1 and Q_2** . It is called the Coulomb force

$$\underline{F_E} = \frac{k_e Q_1 Q_2}{r^2} \hat{r}$$

with

$$k_e = 9 \times 10^9 \frac{N \cdot m^2}{C^2}$$



Discover the truth at www.deloitte.ca/careers

Deloitte.

© Deloitte & Touche LLP and affiliated entities.



Click on the ad to read more

However notable differences are:

If Q_1, Q_2 have the same sign (like charges)

$$\underline{F_E} \parallel +\hat{r}$$

And will push Q_1, Q_2 apart:

REPLUSIVE force

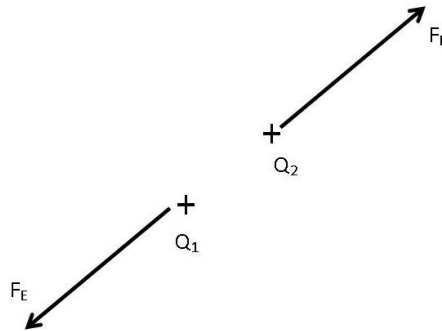

If Q_1, Q_2 have opposite signs (unlike charges)

$$\underline{F_E} \parallel -\hat{r}$$

Pulls Q_1, Q_2 together:

ATTRACTIVE force

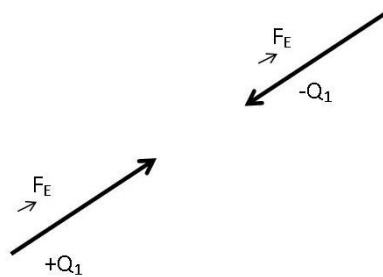

It is instructive to compare the Gravitational force and the Coulomb force between a proton and an electron separated by $0.5 \times 10^{-10} \text{ m}$, the radius of the hydrogen atom

Gravitational Force

$$\underline{F_G} = - \frac{6.7 \times 10^{-11} \times 1.6 \times 10^{-27} \times 9 \times 10^{-31}}{(0.5 \times 10^{-10})^2} N \hat{r}$$

Coulomb Force

$$\underline{F_E} = \frac{-9 \times 10^9 \times 1.6 \times 10^{-19} \times 1.6 \times 10^{-19}}{(0.5 \times 10^{-10})^2} N \hat{r}$$

Both are attractive but the electrostatic force is much bigger:

$\underline{F_E}$ is larger by a factor of 10^{39} !

Note

For a given r :

- (Magnitude of $\underline{F_E}$ between two protons)
- = (Magnitude of $\underline{F_E}$ between two Electrons)
- = (Magnitude of $\underline{F_E}$ between Electron and Proton)

The only difference is that in the first two cases $\underline{F_E} \parallel +\hat{r}$ (repulsion) and in the last case $\underline{F_E} \parallel -\hat{r}$ (attraction)!

SIMPLY CLEVER

ŠKODA



We will turn your CV into an opportunity of a lifetime



Do you like cars? Would you like to be a part of a successful brand? We will appreciate and reward both your enthusiasm and talent. Send us your CV. You will be surprised where it can take you.

Send us your CV on www.employerforlife.com



Click on the ad to read more

NOTICE THAT THE FORCES OCCUR AS ACTION-REACTION PAIRS IN EVERY CASE. $\left[\begin{matrix} \vec{F}_{12} = -\vec{F}_{21} \\ \vec{F}_{21} = -\vec{F}_{12} \end{matrix} \right]$
 The Equations Represent Two Forces

Many Point Charges Force on Q_i

$$\vec{F}_i = k_e \sum_{j \neq i} \frac{Q_i Q_j}{r_{ij}^2} \hat{r}_{ij} \quad \text{Note: Right side involves addition of vectors.}$$

8.1 Special cases

1. Q_1 at $x=0$, Q_2 at $x=L$. Where to locate Q_3 so \vec{F}_3 force on Q_3 is zero.

Q_3 must be on the line joining Q_1 and Q_2 .

$$x = \frac{L}{1 + \sqrt{\frac{Q_2}{Q_1}}}$$

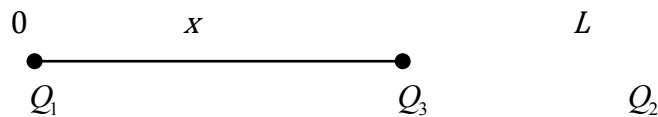

2. Q_1 at $x=0$, $-|Q_2|$ at $x=L$. \vec{F}_3 will be zero if

$$x = \frac{L}{\sqrt{\frac{Q_1}{Q_2}} - 1} \quad \text{when } Q_1 > |Q_2|$$

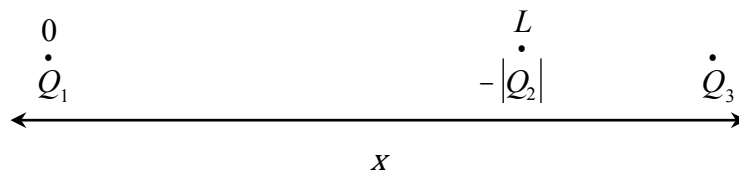

3. Q at $x=-a$, Q at $x= +a$. What is force on q at $(0, y)$

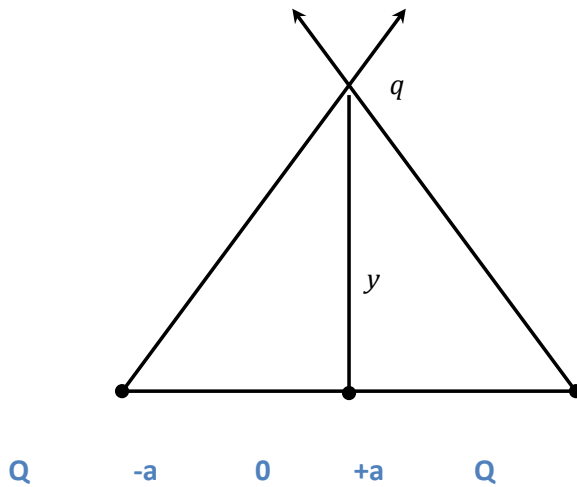

$$\underline{F_E}(y) = \frac{2k_e Q y q}{(y^2 + a^2)^{3/2}} \hat{y}$$

What if we have $-|q|$ at $(0, y)$

$$\frac{-2k_e |q| Q y \hat{y}}{(y^2 + a^2)^{3/2}}$$

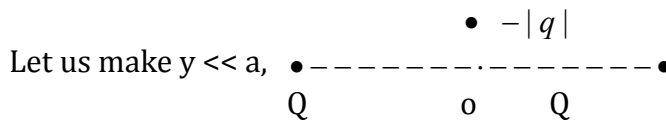

In this case, force is proportional to displacement y and opposite to it so $-|q|$ will show Linear Harmonic oscillations.

QUESTION: Why is there a force between two charges (masses) when they are far apart from one another?
To answer this we develop the concept of a **FIELD**

<u>COULOMB \vec{E}- FIELD</u>	<u>GRAVITATIONAL(\vec{G}_F) FIELD</u>
<p>If there is a charge Q sitting at $x=0$, the space around it is <u>not</u> empty. Q creates a coulomb \vec{E} field which permeates all of space. If you place a test charge q in this \vec{E} field, it experiences a force $\vec{F_E} = q \vec{E}$</p>	<p>If there is a mass M sitting at $x=0$, the space around it is not empty. M creates a gravitational (\vec{G}_F) field which permeates all of space. If you place a test mass m in the \vec{G} field it experiences a force $\vec{F_G} = m \vec{G}_F$</p>

9 The \vec{E} Field Coulomb / Gravitational Field

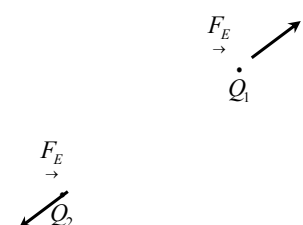
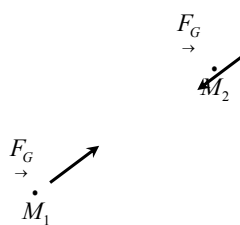
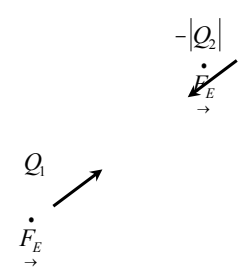
FORCE BETWEEN TWO POINT CHARGES	FORCE BETWEEN TWO POINT MASSES
$\vec{F}_E = k_e \frac{Q_1 Q_2}{r^2} \hat{r}$ $k_e = 9 \times 10^9 \frac{N \cdot m^2}{C^2}$	$\vec{F}_G = - \frac{GM_1 M_2}{r^2} \hat{r}$ $G = 6.7 \times 10^{-11} \frac{N \cdot m^2}{(kg)^2}$
<p>Q_1, Q_2 same sign $\vec{F}_E \parallel +\hat{r}$</p>	<p>F_G ALWAYS ATTRACTIVE $\vec{F}_G \parallel -\hat{r}$ (Both Forces Inward)</p>
<p>REPULSIVE (Both Forces Outward)</p> 	
<p>Q_1, Q_2 have opposite signs. $\vec{F}_E \parallel -\hat{r}$ (Both Forces Inward)</p>	
<p>ATTRACTIVE</p> 	

9.1 Formal Definitions:

\underline{G}_F : If a stationary mass M feels a force and there is no visible agency applying the force, then M must be located in a gravitational field. \underline{E} : If a stationary charge Q feels a force and there is no visible agency applying the force then Q must be located in an \underline{E} -field.

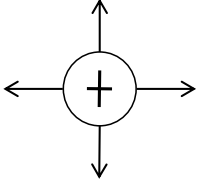
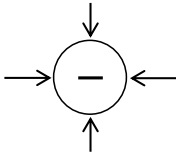
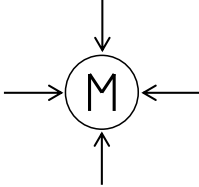
<p>1. Single +ive charge Q at $r=0$.</p> $\underline{E} = \frac{k_e Q}{r^2} \hat{r}$  <p>Acts like a “source” of an \underline{E} field which points radially outward</p> <p>2. Single -ive charge at $r=0$.</p> $\underline{E} = -k_e \frac{ Q }{r^2} \hat{r}$  <p>Acts like a “sink” of \underline{E} field which points. Radially inward.</p>	 $\underline{G}_F = -\frac{GM}{r^2} \hat{r}$ <p>ALWAYS INWARD RADIALLY.</p>
---	---

3. \vec{E} field of Dipole: $-|Q|$ at $x=-a$
 $+Q$ at $x = a$

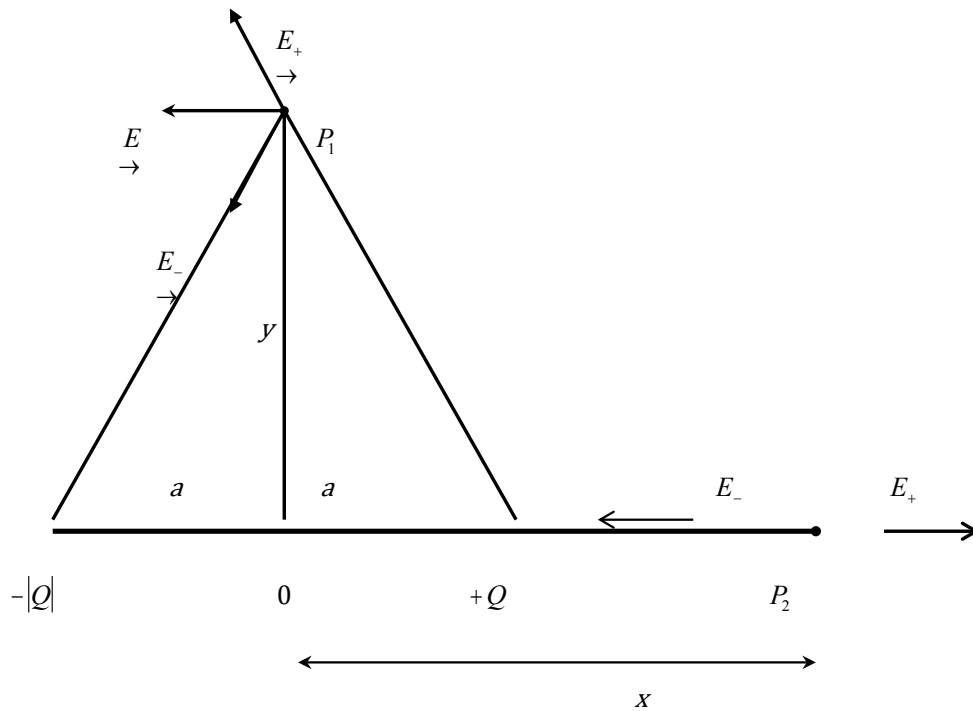

I joined MITAS because
 I wanted **real responsibility**

The Graduate Programme
 for Engineers and Geoscientists
www.discovermitas.com



Month 16

I was a construction
 supervisor in
 the North Sea
 advising and
 helping foremen
 solve problems

Real work
 International opportunities
 Three work placements



Click on the ad to read more

$$\text{at } P_1 = (0, y) \quad \underline{E}(y) = -\frac{k_e 2aQ}{(y^2 + a^2)^{3/2}} \hat{x}$$

$$\text{at } P_2 = (x, 0) \quad \underline{E}(x) = -\frac{k_e 4aQx}{(x^2 - a^2)^2}$$

Next, define dipole moment $\underline{p} = 2aQ\hat{x}$

When $x, y \gg a$ that is far away from dipole

$$\underline{E}(y) = \frac{-k_e \underline{p}}{y^3}$$

$$\underline{E}(x) = \frac{2k_e \underline{p}}{x^3}$$

9.2 Properties of \underline{E} -Field Lines:

Following Faraday we can visualize an \underline{E} -field by drawing \underline{E} -field lines using the following rules.

1. \underline{E} -field lines can start or stop only at charges or head to infinity: start at positive charges, stop at negative charges.
2. The direction of the \underline{E} -field is given by the tangent to the field line.

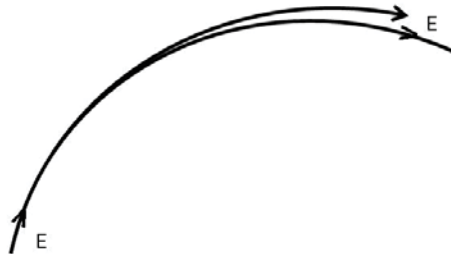

3. On account of 2, no two lines can intersect in space. Otherwise, the \underline{E} -field would have two directions at the same point.
4. The magnitude of \underline{E} is proportional to the number of lines crossing a unit area perpendicular to the lines.
5. In drawing \underline{E} -field lines, the number of lines must be proportional to the charge.

\underline{E} -field lines

1. Two equal positive charges

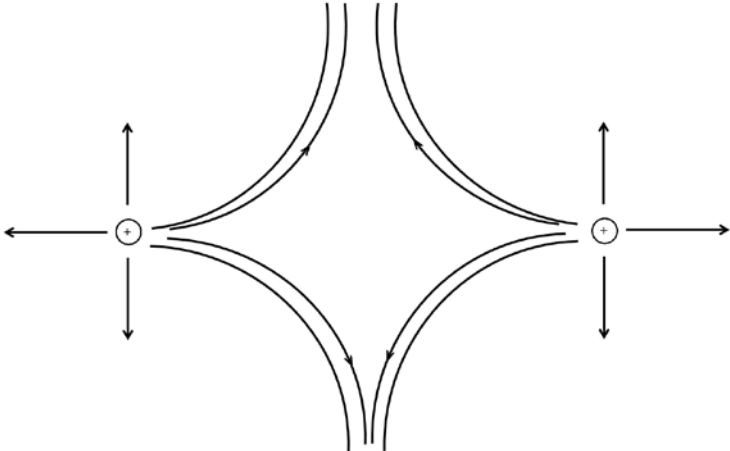

2. Dipole: -Q and +Q

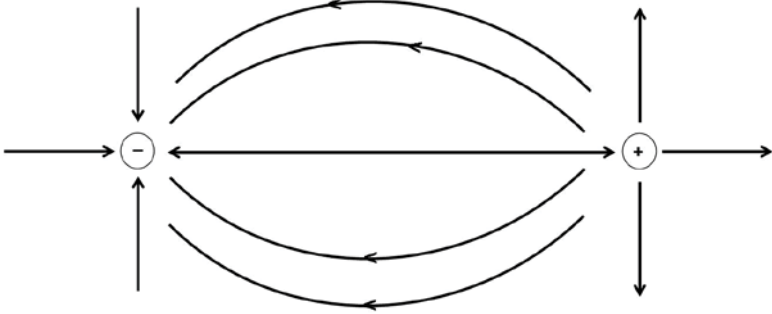

10 Dipole In An \vec{E} -Field

Before solving this problem let us recall the relevant part of Physics I.

1st

CROSS-PRODUCT OF TWO VECTORS: Given two vectors \vec{A} and \vec{B} , their cross-product or vector Product \vec{C} is given by:

$$\vec{C} = \vec{A} \times \vec{B}$$

Magnitude of \vec{C}

$$C = AB \sin(\angle A, B)$$

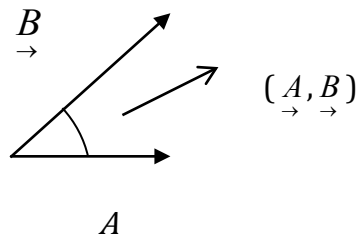



ie business school

#1 EUROPEAN BUSINESS SCHOOL
FINANCIAL TIMES 2013



#gobeyond

MASTER IN MANAGEMENT

Because achieving your dreams is your greatest challenge. IE Business School's Master in Management taught in English, Spanish or bilingually, trains young high performance professionals at the beginning of their career through an innovative and stimulating program that will help them reach their full potential.

- Choose your area of specialization.
- Customize your master through the different options offered.
- Global Immersion Weeks in locations such as London, Silicon Valley or Shanghai.

Because you change, we change with you.

www.ie.edu/master-management
mim.admissions@ie.edu







Direction of \vec{C} is normal to (\vec{A}, \vec{B}) plane that is,

$$\begin{aligned} \vec{C} &\perp \vec{A} \\ \vec{C} &\perp \vec{B} \end{aligned}$$

Supplemented by the right hand rule

Take

$$\begin{aligned} \vec{A} &\parallel \text{Thumb} \\ \vec{B} &\parallel \text{Fingers} \end{aligned}$$

Then

\vec{C} is \perp palm of right hand

2nd

TORQUE: When a force \vec{F} is applied at some distance r from a pivot pt. P on an extended object such as a bar, the bar turns about the pivot point on an axis which is perpendicular both to \vec{r} and \vec{F} , this turning is controlled by the torque (vector) $\vec{\tau}$. Just as a force is required to cause an object to change its linear momentum (center of mass velocity) Torque is needed to change angular velocity (angular momentum). FORCE CAUSES LINEAR ACCELERATION, (TRANSLATION) TORQUE CAUSES ANGULAR ACCELERATION (ROTATION).

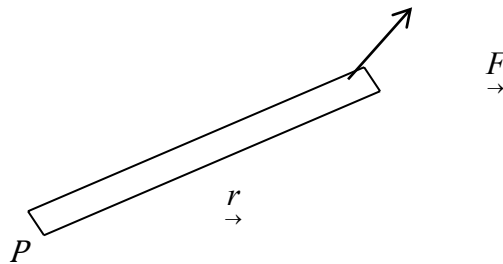

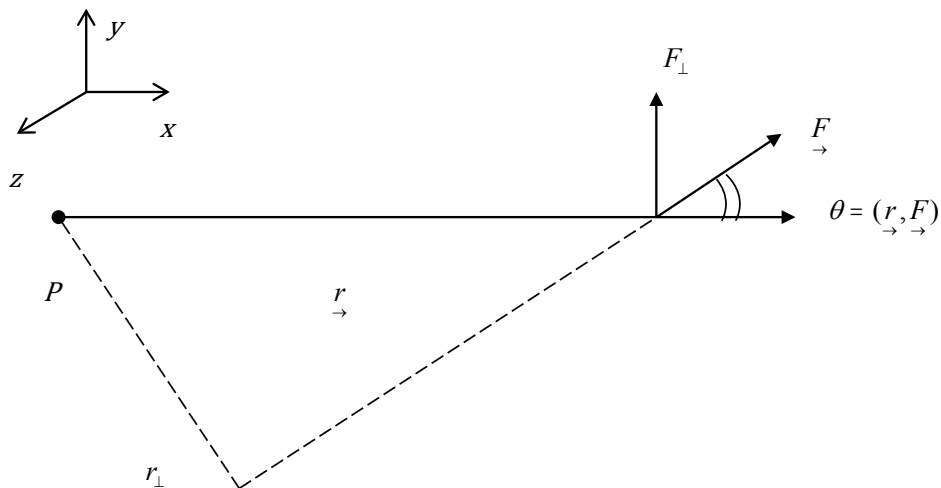

Notice that in turning the bar about an axis through P , only component of $\vec{F} \perp \vec{r}$ matters or alternatively, the moment arm r_{\perp} controls τ .

$$\begin{aligned} \vec{\tau} &= [\vec{r} \times \vec{F}] \\ &= r F \sin\theta \hat{z} \end{aligned}$$

Thus magnitude of Torque is $\tau = rF_{\perp} = r_{\perp}F = rF \sin(\vec{r}, \vec{F})$ with the right hand rule for the picture above.

STUDY AT A TOP RANKED INTERNATIONAL BUSINESS SCHOOL

Reach your full potential at the Stockholm School of Economics, in one of the most innovative cities in the world. The School is ranked by the Financial Times as the number one business school in the Nordic and Baltic countries.

Visit us at www.hhs.se



Now let us put a dipole $\vec{p} = aQ\hat{p}$ in an \vec{E} field.

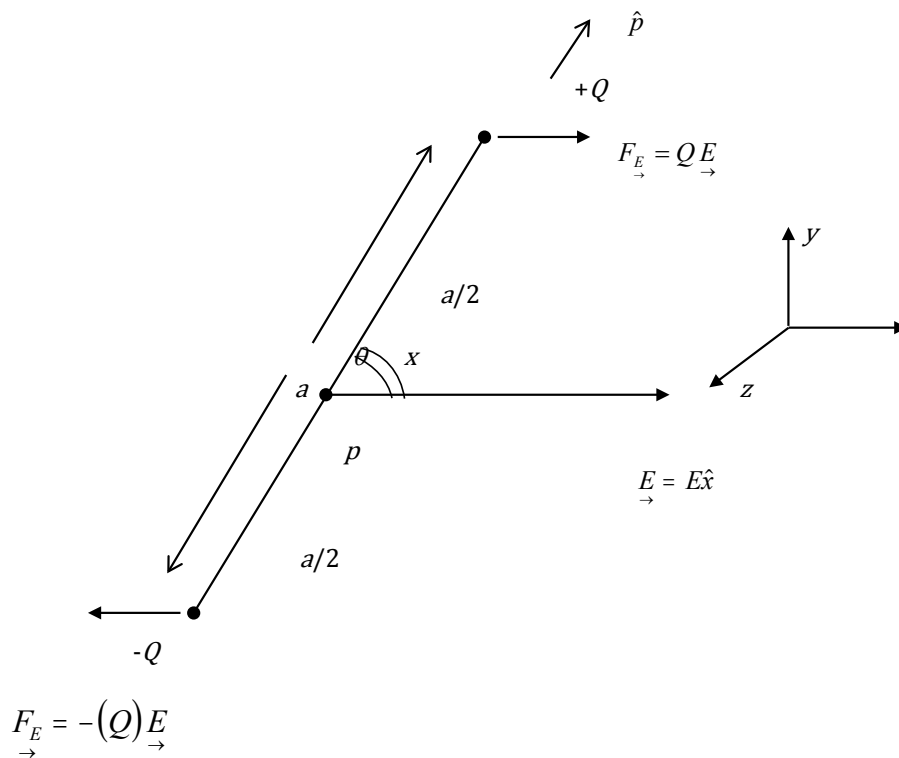

Notice there are two forces on the Dipole. $+QE$ & $-|Q|E$, so total force is zero. Take torque about pivot point P (mid pt. Of Dipole). It is the sum of two torques.

Magnitude

$$\begin{aligned} \tau &= \frac{a}{2}QE \sin\theta + \frac{a}{2}QE \sin\theta \\ &= aQE \sin\theta \\ &= pE \sin\theta \end{aligned}$$

And for the geometry shown and using the right hand rule one can write $\vec{\tau} = [\underline{p} \times \underline{E}]$

Because mag. is $pE \sin\theta$ & direction is \perp paper pointing down! $\vec{\tau} = -pE \sin\theta \hat{z}$

Potential Energy of DIPOLE IN \vec{E} - field .

$$\text{Work done } \Delta W = \vec{\tau} \cdot \Delta \vec{\theta} \quad [\Delta W = \vec{F} \cdot \Delta \vec{x}]$$

$$\vec{\tau} = -pE \sin\theta \hat{z}$$

$$\Delta \vec{\theta} = \Delta \theta \hat{z}$$

$$\Delta W = -pE \sin\theta \Delta \theta$$

Change of Potential Energy $\Delta U_E = -\Delta W = +pE \sin\theta \Delta \theta$

Hence $U_E = -(\vec{P} \cdot \vec{E}) = -pE \cos\theta$

SO DIPOLE WILL TURN AND BECOME PARALLEL To \vec{E} field at $\theta = 0$.

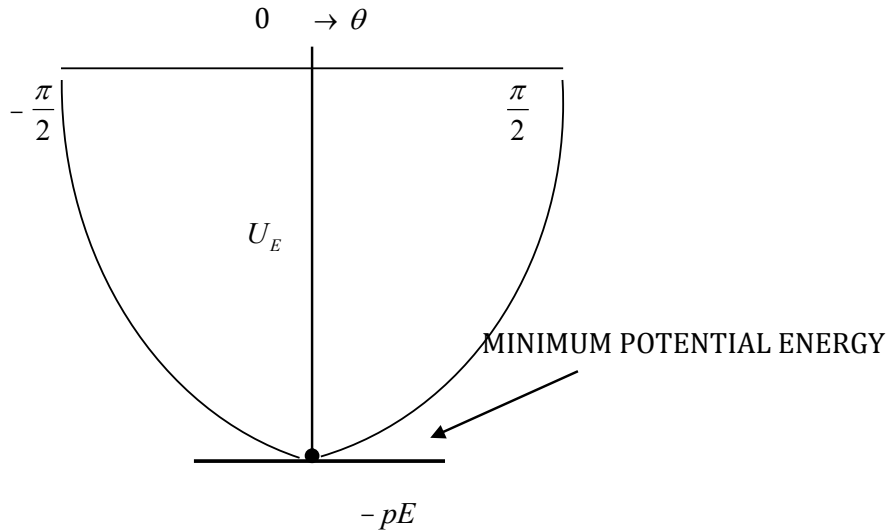

FINALLY, NOTE THAT FOR $\theta < \pi/2$, $\Delta U_E \propto \theta^2$ or $\tau \propto -\theta \hat{z}$, so you get Linear Harmonic Oscillations, that is, for small θ dipole will oscillate about \vec{E} . In other words, dipole is in $\theta = 0$ when it is parallel to \vec{E} , if you pull it aside by a small angle θ and let go it will oscillate about \vec{E} .



11 Flux of \vec{E} -Field: Coulomb \vec{E} -Field, Gauss' Law

We use the analogy of water flowing into (out of) a sink (source) to imagine the \vec{E} -field surrounding a point charge.

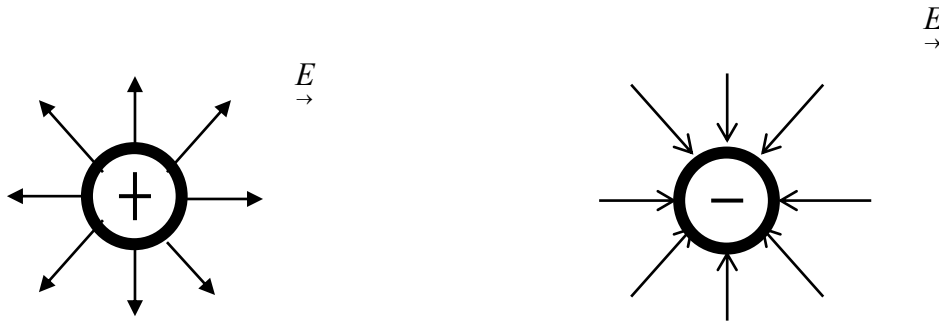

Just as we talk of the amount of water flowing through an area, we now talk of the FLUX of \vec{E} as the quantity

$$\Delta\Phi_E = \vec{E} \cdot \Delta\vec{A} = E\Delta A \cos(E, \hat{n})$$

as a measure of the “amount” of \vec{E} -field “flowing” out of or into a surface of area $\Delta\vec{A} = \Delta A \hat{n}$

Example

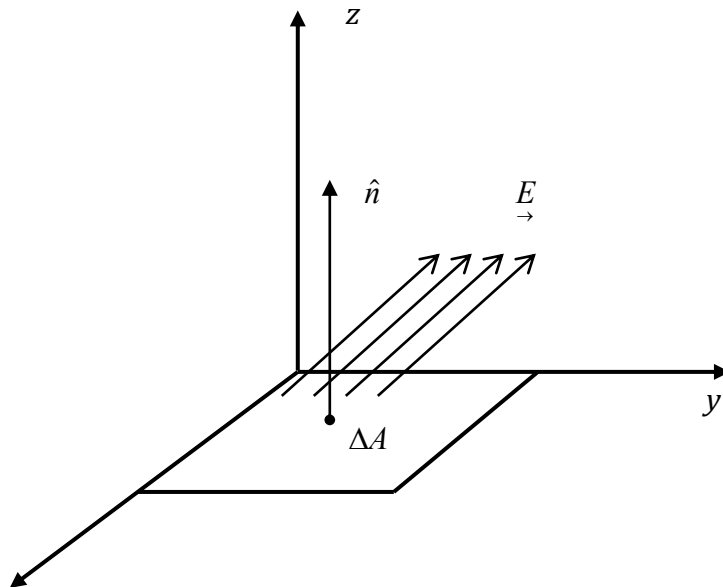

Take area ΔA lying in xy -plane z

$$\begin{aligned}\vec{\Delta A} &= \Delta A \hat{n} \\ &= \Delta A \hat{z}\end{aligned}$$

Take $\vec{E} = E_y \hat{y} + E_z \hat{z}$

Notice:

FLUX IS MAXIMUM

when $\vec{E} \parallel \hat{n}$. x

FLUX IS ZERO

when $\vec{E} \perp \hat{n}$

Thus

$$\Delta \Phi_E = E \Delta A \cos(\vec{E}, \hat{z})$$

or

$$\Delta \Phi_E = (\Delta A) E_z$$

That is only component of \vec{E} parallel to \hat{z} contributes to flux of \vec{E} through ΔA . [To go through a door you must travel along its normal]

Example:

Consider a cube. Let $\vec{E} = E \hat{x}$

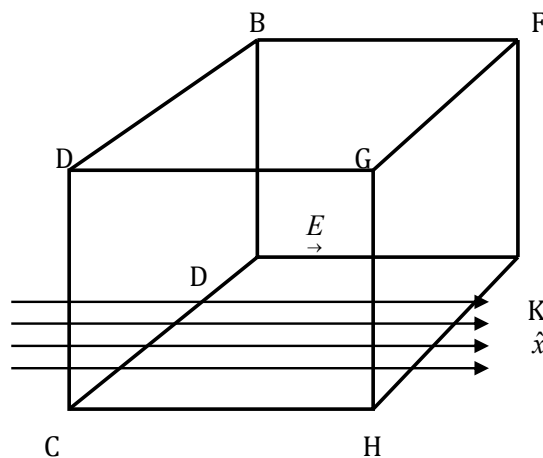

NO SOURCE OR SINK INSIDE CUBE

Flux of \vec{E} is non-zero only over faces ABCD and FGHK.

Over ABCD flux is into Cube

Over FGHK flux is out of Cube

TOTAL FLUX THROUGH CUBE=0 AS IT MUST BE BECAUSE THERE IS NO SOURCE OR SINK INSIDE IT. EVERY LINE THAT COMES IN MUST LEAVE [LINES STOP (START) AT SINKS (SOURCES) ONLY].

So it is not surprising that Gauss' Law says: THE TOTAL FLUX OF THE \vec{E} -FIELD THROUGH A CLOSED SURFACE IS DETERMINED SOLELY BY THE SOURCES (+CHARGES) AND SINKS (-CHARGES) IN THE VOLUME ENCLOSED BY THE SURFACE.

$$\text{Mathematically, } \sum_c \vec{E} \cdot \Delta\vec{A} = \sum_c E_{\perp} \Delta A = \frac{1}{\epsilon_0} \sum Q_i \tag{I}$$

Where $\frac{1}{4\pi\epsilon_0} = k_e = 9 \times 10^9 \frac{N \cdot m^2}{C^2}$, $\epsilon_0 = 9 \times 10^{-12} \frac{F}{m}$

The \sum_c on the left hand side is sum of the flux over **all** parts of the closed surface. $\sum Q_i$ is the algebraic sum of all the enclosed charges.

Example:

In general, Gauss' law would be very difficult to use to calculate \vec{E} . All it can give us is the total flux once the Q_i 's are known. Here are 4 charges. If you draw any surface enclosing all of them we can write down the total flux of \vec{E} immediately.

S_1, S_2, S_3 are any three closed surfaces drawn around our four charges. In each case

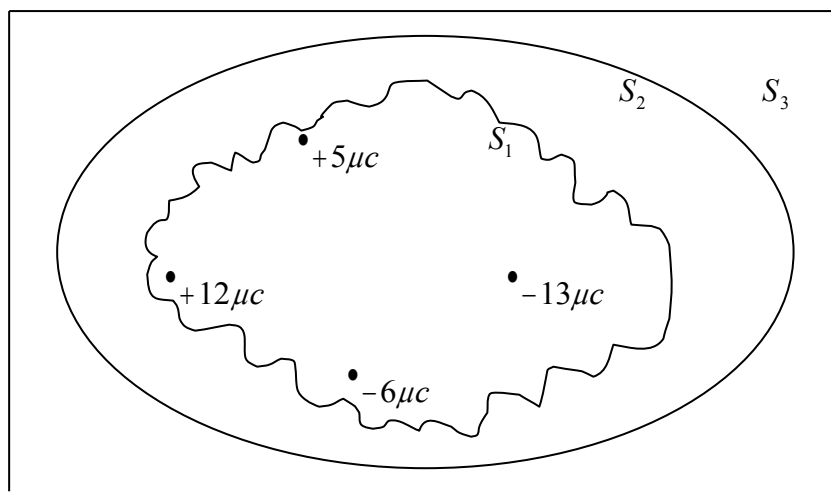

$$\begin{aligned}\Sigma_c \vec{E} \cdot \Delta \vec{A} &= \frac{1}{9 \times 10^{-12}} [5 \times 10^{-6} + 12 \times 10^{-6} - 6 \times 10^{-6} - 13 \times 10^{-6}] \\ &= -2.2 \times 10^5 \frac{N \cdot m^2}{C}\end{aligned}$$

but it tells you nothing about the \vec{E} -field at any point on any surface.

However, there are some special cases where we can use this law to calculate \vec{E} -field in one step. [*Please look at Physics I to recall similar results for Gravitational field.*]

The calculation depends crucially on recognizing the symmetry of the problem and choosing the Gaussian Surface in such a way that the sum on the left of Eq. 1 can be calculated right away.

"I studied English for 16 years but...
...I finally learned to speak it in just six lessons"

Jane, Chinese architect

ENGLISH OUT THERE

Click to hear me talking before and after my unique course download

11.1 Example 1

Point charge $+Q$ located at the origin, $r=0$. Because of spherical symmetry about $r=0$, the \vec{E} -field cannot depend on angle. It must be radial (*along* \hat{r}) and be a function of r only. We should choose for our surface a sphere of radius r centered at $r=0$. Then I) E has the same magnitude at all points on the surface of the sphere and II)

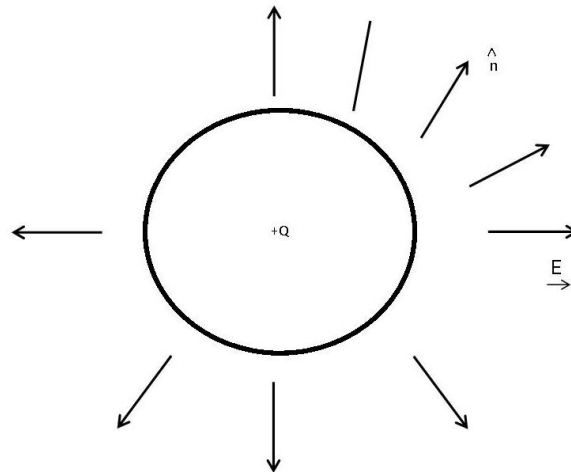

$$\vec{E} \cdot \vec{\Delta A} = E(r)4\pi r^2 = \frac{Q}{\epsilon_0}$$

because

$$\vec{E} \parallel \hat{r} \text{ everywhere so } \vec{E} \cdot \hat{n} = E$$

$$\vec{E} = \frac{Q}{4\pi\epsilon_0 r^2} \hat{r} = \frac{k_e Q}{r^2} \hat{r}$$

11.2 Example 2

$-|Q|$ Located at $r=0$. Again \vec{E} can only be a function of r and directed along $-\hat{r}$ so (*FLUX is inward*)

$$-E \cdot 4\pi r^2 = \frac{-|Q|}{4\pi\epsilon_0}$$

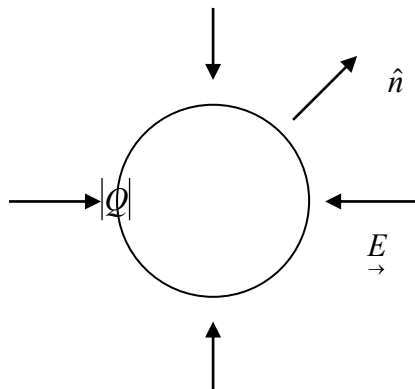

$$\vec{E}(r) = \frac{-|Q|}{4\pi\epsilon_0} \hat{r} \text{ angle between } \hat{n} \text{ \& } \vec{E} \text{ is } 180^\circ$$

11.3 Example 3

Long Line of charge: λ C/m along \hat{z} . Now there is cylindrical symmetry about z -axis.

Field cannot depend on z .

Field cannot depend on Angle.

Must be a function of r only and directed along r .

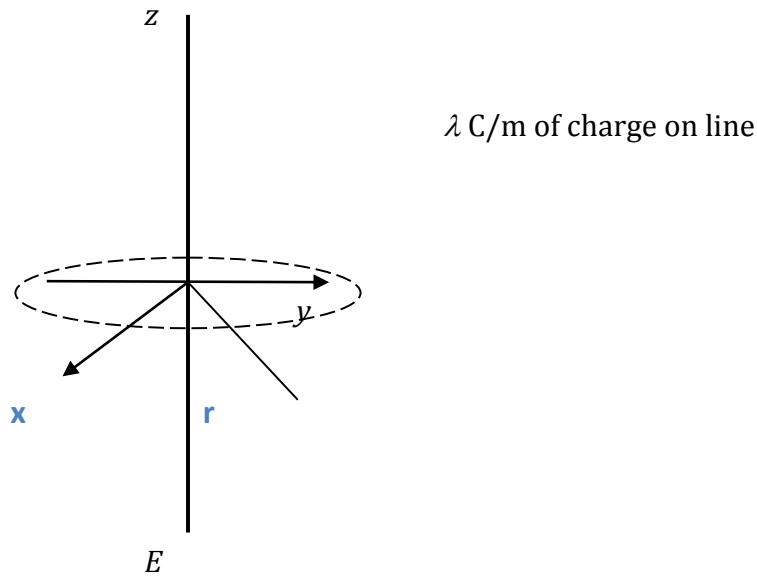

Choose as surface cylinder of length L , radius r , axis of cylinder on z -axis. Then $\sum_c \vec{E} \cdot \Delta \vec{A} = E(r)2\pi rL$.
No contribution from End surfaces as \vec{E} is parallel to them.

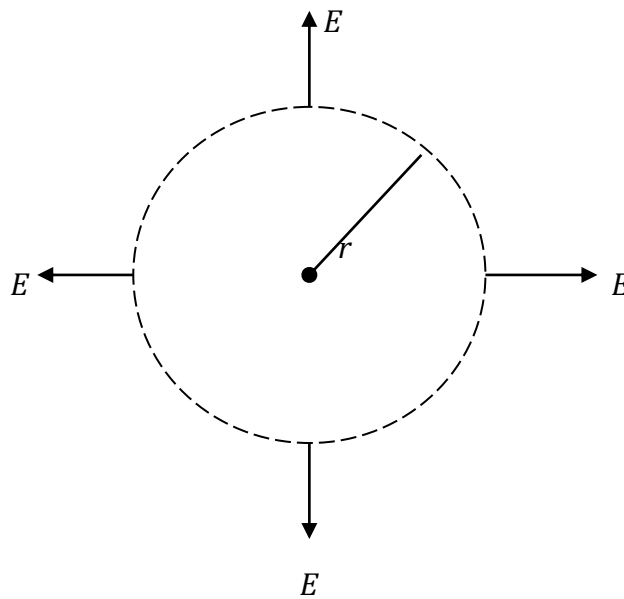

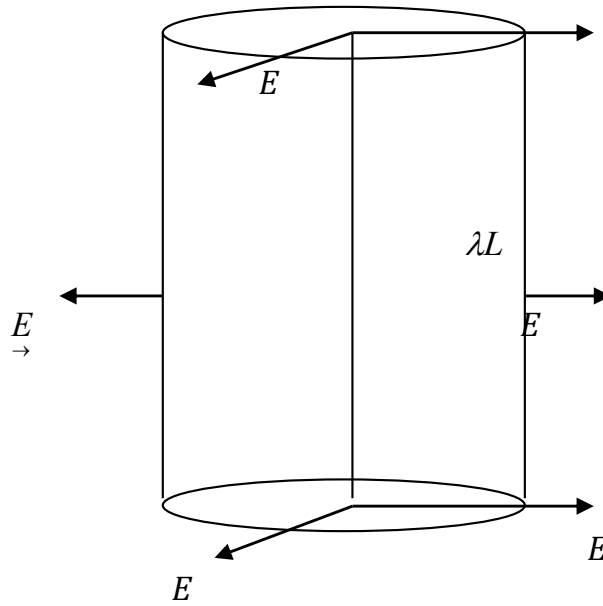

Also

$$\sum Q_i = \lambda L$$

so

$$E(r) \cdot 2\pi r L = \lambda L$$

$$\vec{E}(r) = \frac{\lambda}{2\pi\epsilon_0} \hat{r}$$

Excellent Economics and Business programmes at:



university of
 groningen



“The perfect start
 of a successful,
 international career.”

CLICK HERE
 to discover why both socially
 and academically the University
 of Groningen is one of the best
 places for a student to be

www.rug.nl/feb/education



11.4 Example 4

Hollow sphere (spherical shell) has charge $+Q$ on its surface, radius R and is centered at $r=0$. Again symmetry about $r=0$, requires that $\vec{E} \parallel \hat{r}$ and is a function r only.

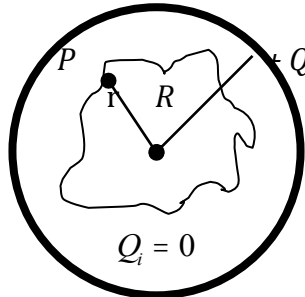

First, consider $r < R$. Choose any surface through r . $r < R$ $\sum_c \vec{E} \cdot \Delta A = 0 \rightarrow$ No enclosed charge.

If $\sum_c \vec{E} \cdot \Delta A = 0$ for any and every surface as long as $r < R$, it implies $\vec{E} = 0$

If $r > R$; the appropriate surface is a sphere of radius r and now $\sum_c \vec{E} \cdot \Delta A = E(r)4\pi r^2$

Hence,

$$\begin{aligned} \vec{E} &= \frac{Q}{4\pi\epsilon_0 r^2} \hat{r} \\ &= \frac{k_e Q}{r^2} \hat{r} \\ r &> R \end{aligned}$$

as if the shell were replaced by a single charge Q located at its center ($r=0$). That is, r must be measured from the center of the shell.

Sph. Shell: Q on shell

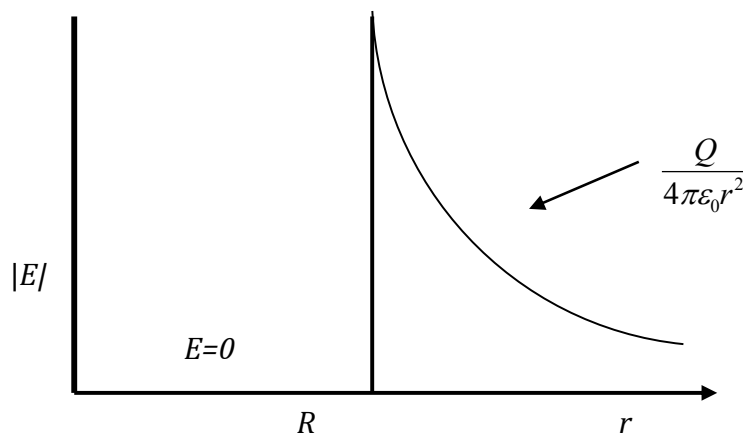

Note: As one goes from $r < R$ to $r > R$, the \vec{E} -field jumps by

$$E = \frac{Q}{4\pi\epsilon_0 r^2} \quad \left[\sigma = \frac{Q}{4\pi r^2} \right]$$

$$= \frac{\sigma}{\epsilon_0}$$

Where σ = charge density on the surface of the shell. Crossing a sheet of charge \vec{E} jumps!

Ex5: Insulating Solid Sphere

Charge Q distributed uniformly over a sphere of radius R which is located with its center at $r=0$. First

define charge density $\rho = \frac{Q}{\frac{4\pi}{3}R^3}$ [$\rho = Rho$]

Again, spherical symmetry obtains about $r=0$.

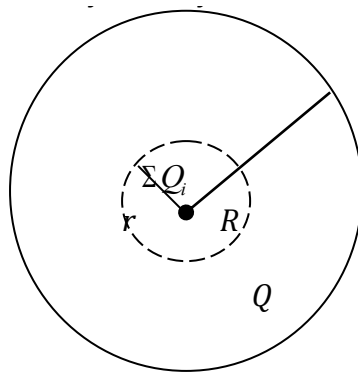

Now, if $r < R$.

$$\sum_c \vec{E} \cdot \Delta \vec{A} = E(r) 4\pi r^2$$

$$\sum Q_i = \rho \cdot \frac{4\pi}{3} r^3$$

so for $r < R$.

$$E(r) 4\pi r^2 = \frac{\rho}{\epsilon_0} \cdot \frac{4\pi}{3} r^3$$

$$\vec{E} = \frac{\rho}{3\epsilon_0} r \hat{r} \quad r < R$$

If $r > R$ all of Q contributes so

$$\vec{E} = \frac{Q}{4\pi\epsilon_0 r^2} \hat{r} \quad r > R$$

INSULATING SPHERE UNIFORMLY CHARGED with $\rho = \frac{Q}{\frac{4\pi}{3}R^3}$

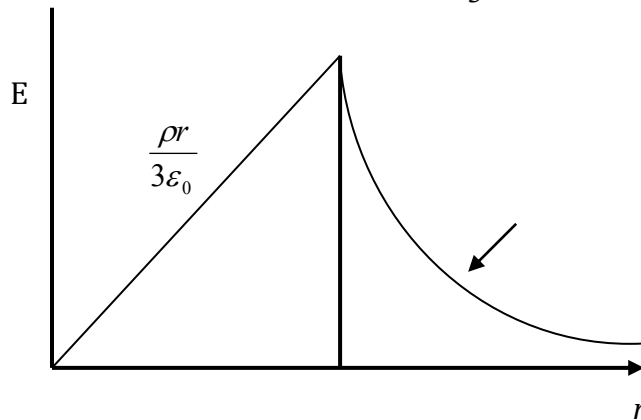

Ex 6:

Conductor under stationary conditions: charge **NOT** allowed to move. If charge has to be immobile the field inside must be **zero** at every point. This is possible only if $Q=0$ at every point inside the conductor. So under stationary conditions charge can reside **ONLY ON** the surface of the conductor **consequences:**

In the past four years we have drilled
89,000 km
 That's more than **twice** around the world.

Who are we?
 We are the world's largest oilfield services company¹. Working globally—often in remote and challenging locations—we invent, design, engineer, and apply technology to help our customers find and produce oil and gas safely.

Who are we looking for?
 Every year, we need thousands of graduates to begin dynamic careers in the following domains:

- Engineering, Research and Operations
- Geoscience and Petrotechnical
- Commercial and Business

What will you be?

careers.slb.com

Schlumberger

¹Based on Fortune 500 ranking 2011. Copyright © 2015 Schlumberger. All rights reserved.



Q on conducting sphere \equiv Hollow spherical charge

Further, \vec{E} at surface must be perpendicular to surface otherwise charges will start moving along surface.

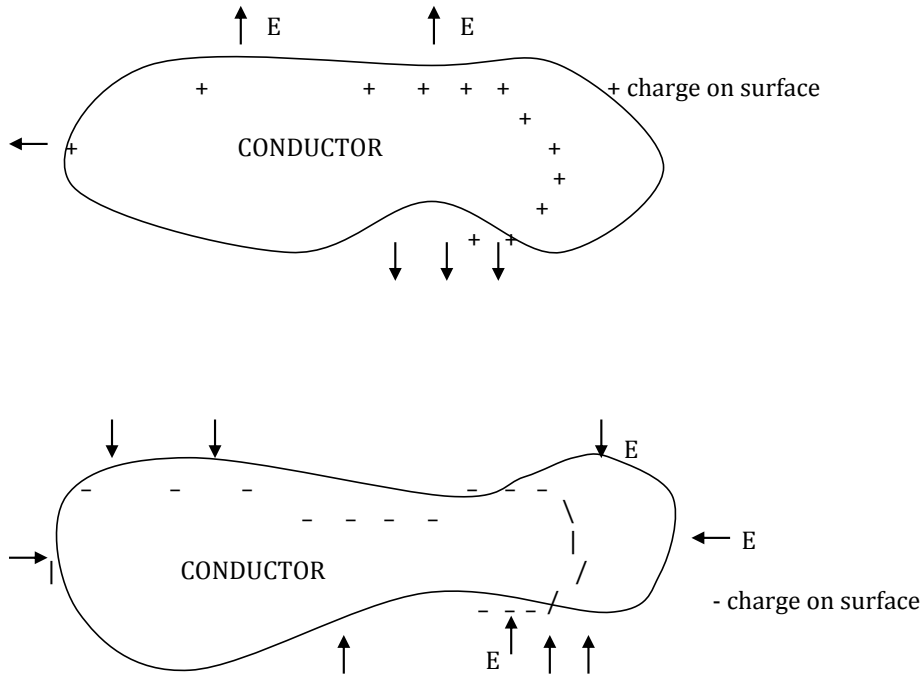

Notice: In both cases force on charge is outward, that is, charge is bound to the surface.

Ex 7:

Sheet of charge \perp x -axis carries $+\sigma \text{ C/m}^2$ of charge. Sheet located at $x=0$. Look at it end-on Recall that we have shown if two equal charges are at $+y$ and $-y$ the \vec{E} field is purely along \hat{x} .

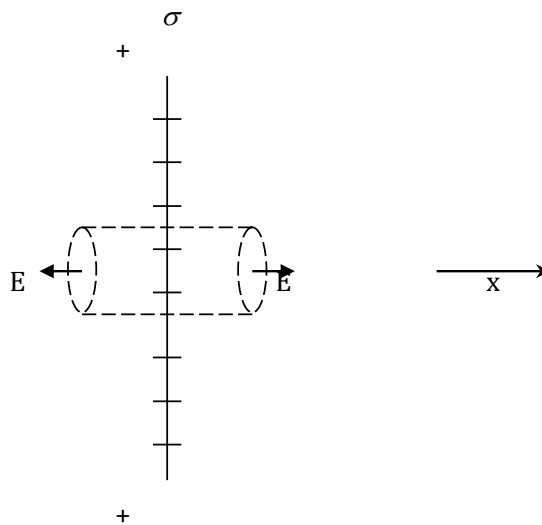

So here \vec{E} along $+\hat{x}$ on right $-\hat{x}$ on left. Choose cylinder as Gaussian Surface.

$$\begin{aligned}\Sigma_c \vec{E} \cdot \Delta \vec{A} &= E\pi r^2 + E \cdot \pi r^2 \\ &= E \cdot 2\pi r^2\end{aligned}$$

and

$$\Sigma Q_i = \sigma \pi r^2 \text{ [charge enclosed by cylinder]}$$

so

$$2E\pi r^2 = \sigma \cdot \pi r^2$$

$$\vec{E} = + \frac{\sigma}{2\epsilon_0} \hat{x} \quad x > 0$$

$$= - \frac{\sigma}{2\epsilon_0} \hat{x} \quad x < 0$$

Ex 7:

Sheet carries $-\sigma \text{ C/m}^2$

$$\text{Then } \vec{E} = - \frac{\sigma}{2\epsilon_0} \hat{x} \quad x > 0$$

$$= + \frac{\sigma}{2\epsilon_0} \hat{x} \quad x < 0$$

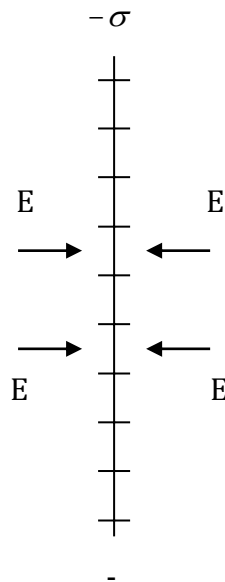

Ex 8:

Sheet at $x=0$, $\sigma \text{ C/m}^2$

Now the \vec{E}_+ and \vec{E}_- fields will add vectorially. Hence Sheet at $x=d$, $-\sigma \text{ C/m}^2$

$$\vec{E} = 0, x < 0$$

$$\vec{E} = \frac{\sigma}{\epsilon_0} \quad 0 < x < d$$

$$\vec{E} = 0 \quad x > d$$

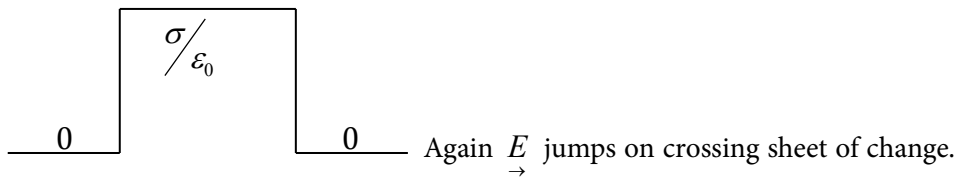
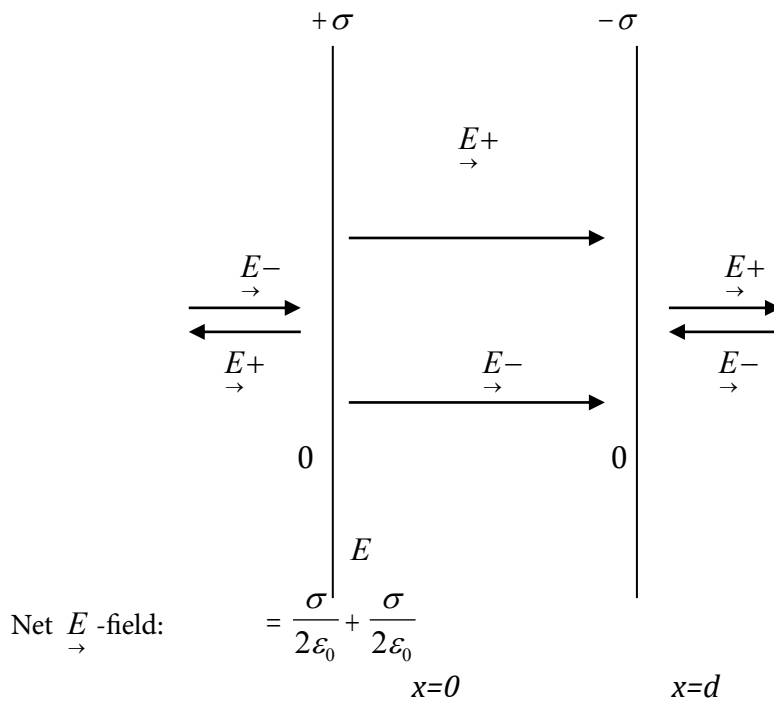

12 Energy Conservation Principle Revisited: Electric Potential

Now that we have a new force

$$\underline{F}_E = \frac{k_e Q_1 Q_2}{r^2} \hat{r} \quad \longrightarrow (1)$$

And a new field

$$\underline{E} = \frac{\underline{F}_E}{q} \quad \longrightarrow (2)$$

We need to take another look at the Principle of Conservation of Energy.

First, let us recall some of our discussion from Physics I where we talked only of mechanical energy:

American online

LIGS University

is currently enrolling in the
Interactive Online **BBA, MBA, MSc,**
DBA and PhD programs:

- ▶ enroll **by September 30th, 2014** and
- ▶ **save up to 16%** on the tuition!
- ▶ pay in 10 installments / 2 years
- ▶ Interactive Online education
- ▶ visit www.ligsuniversity.com to find out more!

Note: LIGS University is not accredited by any nationally recognized accrediting agency listed by the US Secretary of Education. More info [here](#).





Mechanical Work

$$\Delta W = \underline{F} \bullet \underline{\Delta S} = F\Delta S \cos(\underline{F}, \underline{\Delta S})$$

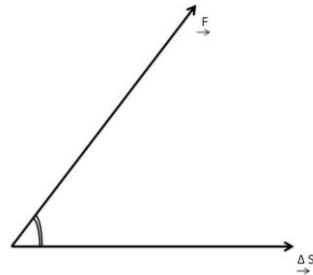

Where

\underline{F} = Force Vector

$\underline{\Delta S}$ = Displacement Vector

Note $\Delta W = 0$ if $\underline{F} \perp \underline{\Delta S}$, that is only component of $\underline{F} \parallel \underline{\Delta S}$ does work

Kinetic Energy

Work stored in motion: if an object of mass M is sitting at rest, the work required to give it a speed V is stored as Kinetic Energy

$$K = \frac{1}{2}MV^2$$

or since linear momentum $\underline{p} = M\underline{V}$ we can write $K = \frac{p^2}{2M}$

Potential Energy (U) Presents a greater conceptual challenge.

U is the mechanical work stored in a system when it is prepared (or put together) in the presence of a prevailing conservative force.

Supposed we have a region of space in which there is a prevailing force (weight near Earth's surface comes to mind). That is, at every point in this region an object will experience a force. Let the object be at point B [First, notice that you can't let the object go as \underline{F} will immediately cause \underline{a} and object will move].

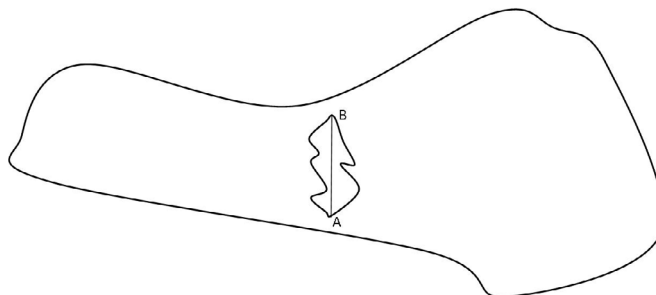

To define U at B we have to calculate how much work was needed to put the object at B in the presence of \underline{F} . Let us pick some point A , where we can claim that U is known, and calculate the work needed to go from A to B . As soon as we try to do that we realize that the only way we can get a meaningful answer is if the work required to go from A to B is independent of the path taken. So our prevailing force has to be special. Such a force is called a **CONSERVATIVE FORCE – WORK DONE DEPENDS ONLY ON END-POINTS AND NOT ON THE PATH TAKEN.**

If that is true we have a unique answer

$$\Delta W_1 = \Delta W_2 = \Delta W_3 = \Delta W_{AB}$$

and we can use this fact to calculate change in U in going from A to B

$$\Delta U_{AB} = -\underline{F} \bullet \underline{\Delta S}_{AB}$$

NOTE THE NEGATIVE SIGN: it comes about because as stated above we cannot let the object go. In fact, the displacement from A to B must be carried out in such a way that the object cannot change its speed (if any). That is, we need to apply a force $-\underline{F}$ to balance the ambient \underline{F} at every point. The net force will become zero at all points. ΔU_{AB} is work being done by $-\underline{F}$.

So when \underline{F} is conservative ΔU_{AB} is unique. In the final step we can choose A such that $U_A = 0$. Then $U_B = -\underline{F} \bullet \underline{\Delta S}_{AB}$

Using the above definition we discussed two cases

- (i) U for Earth-Mass

System: Near earth

The Conservative Force is

$$\underline{F}_g = -Mg\hat{y}$$

Hence

$$U_g(y) = +Mgy \quad (3)$$

Taking $U_g = 0$ for $y = 0$

- (ii) U for Mass attached to a spring.

Here the conservative force is

$$\underline{F} = -kx\hat{x}$$

Hence

$$U_{sp}(x) = \frac{1}{2}kx^2 \quad (4)$$

Taking $U = 0$, when $x = 0$ [spring relaxed]

We were then able to write the principle of Mechanical Energy Conservation

$$K_f + U_{gf} + U_{spf} = K_i + U_{gi} + U_{spi} + W_{NCF} \quad (5)$$

Where i and f refer to the initial and final state and W_{NCF} takes account of work done by non-conservative forces (friction for instance) in going from i to f .

When we got to thermodynamic systems we learnt that the system can change its energy in 3 ways.

Exchange heat \mathbf{DQ} with its surroundings because of a temperature difference across a conducting wall

Have mechanical work \mathbf{DW} done on or by it

Change the internal energy stored within it (dU)

The Conservation Law (First Law of Thermodynamics) Became

$$\pm DQ \pm DW \pm dU = 0$$

That is in any thermodynamic process the total change in energy must be **ZERO**

Now, let us look at \underline{F}_E from equation (1). The first step is to examine if it is a conservative force. If so, we can define a potential energy for \underline{F}_E .

Note: in the following proof it is **CRUCIAL** to recognize that \underline{F}_E acts only **along** the line joining the two charges and so work done by \underline{F}_E being

$$\Delta W = \underline{F}_E \bullet \underline{\Delta S}$$

Will be ZERO for any displacement along the circumference (i.e. $\perp \hat{r}$)

Let us fix Q_1 and move Q_2 starting at point A

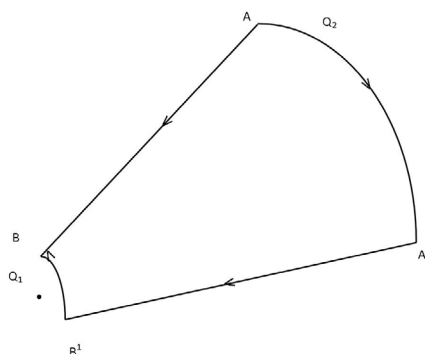

First Path

$\underline{\Delta S}$ is AB along \hat{r} work done will be

$$\Delta W_{AB} = \underline{F}_E \bullet \underline{\Delta S}_{AB}$$

Second Path

First, go from $A \rightarrow A'$ along circumference

$$\Delta W_{AA'} = 0$$

Next go along \hat{r} from A' to B' when $A'B' = AB$

$$\Delta W_{A'B'} = \underline{F}_E \bullet \underline{\Delta S}_{A'B'} = \Delta W_{AB}$$

Next go from B' to B along circumference

$$\Delta W_{B'B} = 0$$

Hence

$$\Delta W_{AA'B'B} = \Delta W_{AB}$$

Work is independent of path \underline{F}_E is indeed conservative, potential energy is definable.

$$\Delta U_E = -\underline{F}_E \cdot \underline{\Delta S}$$

Note the minus sign. As always, the force which does the work must be equal and opposite to the conservative force. ΔU_E is the change in electrostatic potential energy consequent upon a displacement $\underline{\Delta S}$.

The Energy Conservation Equation will now read

$$K_f + U_{gf} + U_{spf} + U_{Ef} = K_i + U_{gi} + U_{spi} + U_{Ei} + W_{NCF} \quad (7)$$

Where again f and i , respectively refer to the final and initial states of the system, and W_{NCF} is work done by non-conservative forces while system goes from i to f .

.....Alcatel-Lucent 

www.alcatel-lucent.com/careers

What if you could build your future and create the future?

One generation's transformation is the next's status quo. In the near future, people may soon think it's strange that devices ever had to be "plugged in." To obtain that status, there needs to be "The Shift".

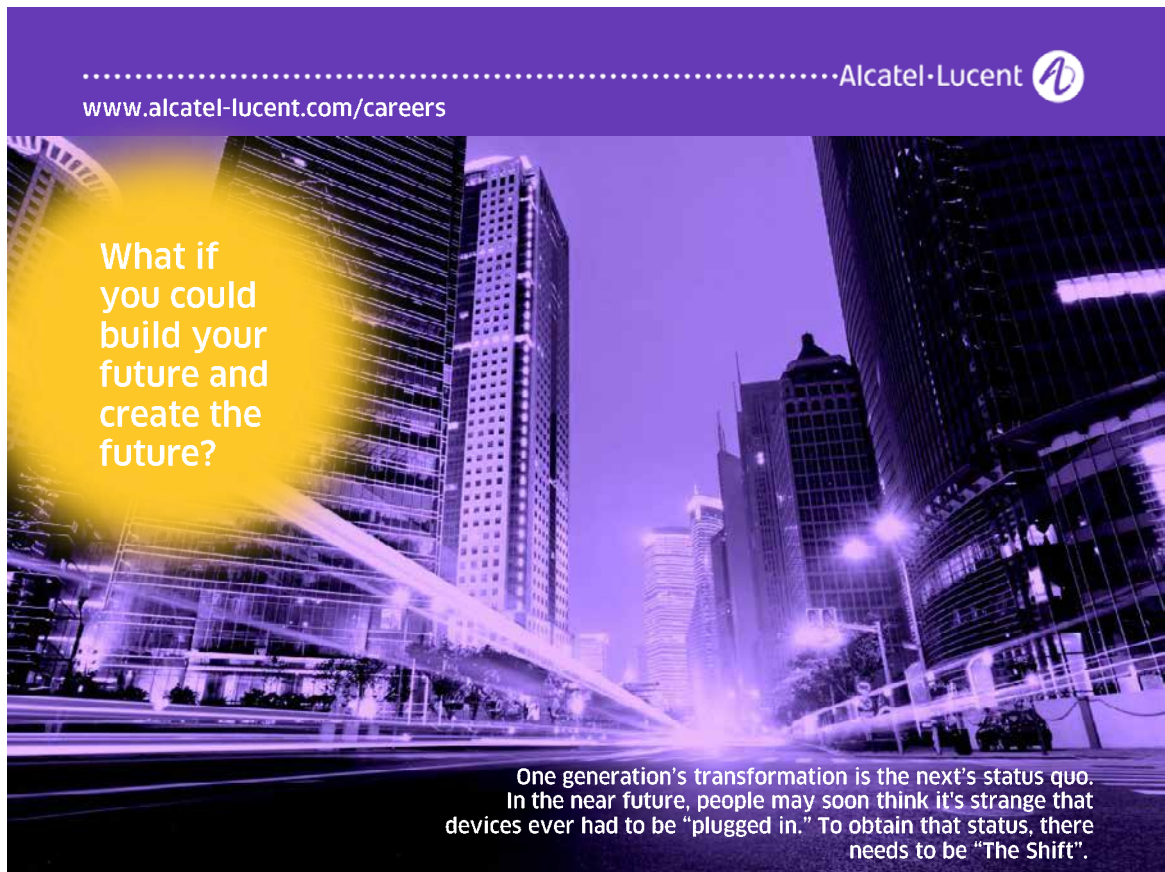

In the present case it is useful to define a new quantity called Electrostatic Potential which is related to ΔU_E by the equation

$$\Delta V = \frac{\Delta U_E}{q} = \frac{-\vec{F}_E \cdot \Delta \vec{S}}{q}$$

Potential $= -\vec{E} \cdot \Delta \vec{S}$

ΔV = change of potential energy per unit charge

Like ΔU_E , ΔV is also a scalar, the dimensions are $ML^2T^{-2}Q^{-1}$ and the unit is Joule/coulomb which is called a Volt.

12.1 Electric Potentials – Special Cases

1. Single plate having charge density $\sigma \text{ C/m}^2$

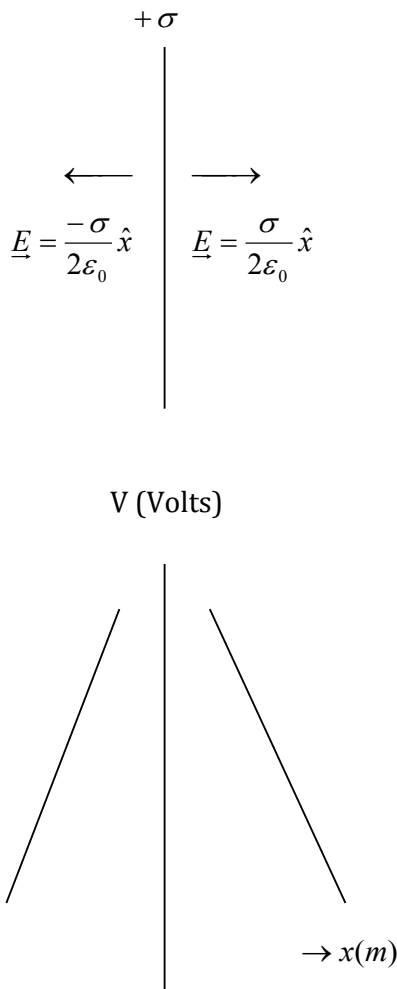

$$\Delta V = -\vec{E} \cdot \Delta \vec{S}$$

Since $-\vec{E} \parallel \hat{x}$

Nonzero ΔV only if $\Delta S \parallel \hat{x}$

$$x > 0 \quad \Delta S = x\hat{x}$$

$$\Delta V = -\frac{\sigma}{2\epsilon_0} x$$

$$x < 0 \quad \Delta S = -x\hat{x}$$

$$\Delta V = \left(\frac{\sigma}{2\epsilon_0}\right)(-x)$$

4. Single $-|Q|$ at $r = 0$

$$\underline{E} = \frac{-k_e Q}{r^2} \hat{r}$$

so $V(r) = \frac{-k_e Q}{r}$

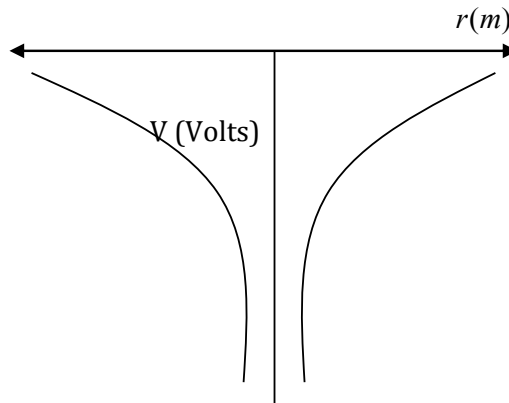

Join the best at
the Maastricht University
School of Business and
Economics!

Top master's programmes

- 33rd place Financial Times worldwide ranking: MSc International Business
- 1st place: MSc International Business
- 1st place: MSc Financial Economics
- 2nd place: MSc Management of Learning
- 2nd place: MSc Economics
- 2nd place: MSc Econometrics and Operations Research
- 2nd place: MSc Global Supply Chain Management and Change

Sources: Keuzegids Master ranking 2013; Elsevier 'Beste Studies' ranking 2012; Financial Times Global Masters in Management ranking 2012

Maastricht University is the best specialist university in the Netherlands
(Elsevier)

Visit us and find out why we are the best!
Master's Open Day: 22 February 2014

www.mastersopenday.nl



Click on the ad to read more

5. Spherical shell or spherical conductor of radius R . In this case charge resides only on the surface hence

$$\text{for } r < R \quad \underline{E} = 0$$

$$\text{for } r > R \quad \underline{E} = \frac{Q}{4\pi\epsilon_0 r^2} \hat{r}$$

The corresponding potential is

$$r > R \quad V(r) = \frac{Q}{4\pi\epsilon_0 r}$$

$$r < R \quad V(r) = \frac{Q}{4\pi\epsilon_0 R}$$

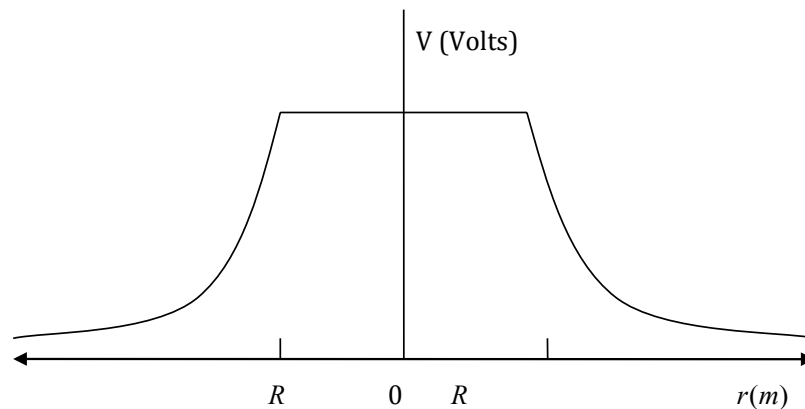

6. Insulating sphere of radius R carries a charge Q distributed uniformly over the sphere so one can define a charge density

$$\rho = \frac{Q}{\frac{4\pi}{3} R^3}$$

now

$$\text{for } r < R \quad \underline{E} = \frac{\rho r}{3\epsilon_0} \hat{r} = \frac{Q r}{4\pi\epsilon_0 R^3} \hat{r}$$

$$\text{for } r > R \quad \underline{E} = \frac{Q}{4\pi\epsilon_0 R^2}$$

so

$$\text{for } r > R \quad V(r) = \frac{Q}{4\pi\epsilon_0 r}$$

$$\text{for } r < R \quad V(r) = \frac{Q}{4\pi\epsilon_0 R} \left[\frac{3}{2} - \frac{r^2}{2R^2} \right]$$

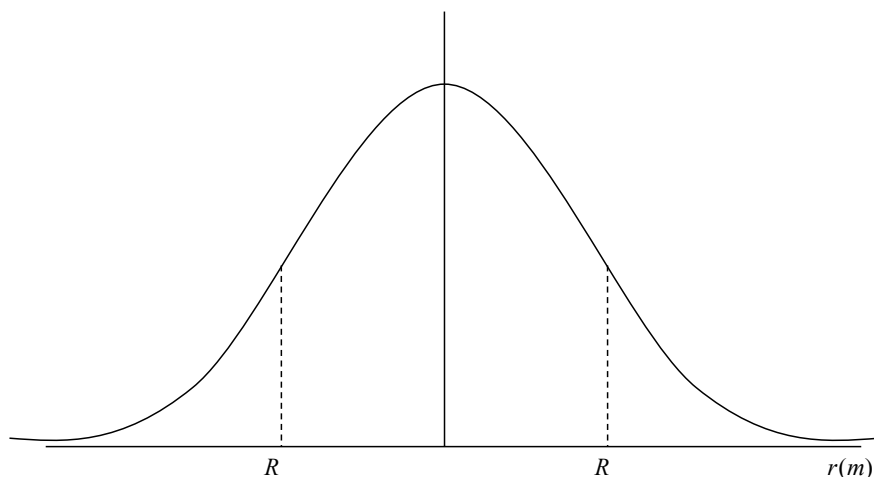

12.2 Equipotentials

Curves (in Two Dimensions) and surfaces (in Three Dimensions) where the Electric potential is constant [$V=\text{constant}$]. There are two important properties of an equipotential

- (i) If a charge moves on an equipotential it will not cost any energy (reminder: it costs no work to move on a closed loop in a conservative force)
- (ii) The \underline{E} field must be perpendicular to an equipotential

Examples

- (i) Plate carrying $+\sigma \text{ C/m}^2$, $\Delta V = \frac{-\sigma}{2\epsilon_0} x$

Equipotentials are planes parallel to plate

- (ii) Pt. charge Q at $\epsilon = 0$, $V(r) = \frac{k_e Q}{r}$

Equipotentials are spheres of radius r whose center is at $r = 0$

- (iii) Surface of a conductor in stationary conditions – charge on surface only, $\underline{E} \perp$ surface everywhere so surface is equipotential.

13 Devices Based On Coulomb \underline{E} -Field

Battery: Produces an \underline{E} -field using chemical energy. Essentially consists of two metal plates dipped in a chemical slurry called an electrolyte which has mobile positive and negative ions. On account of chemical reactions, the positive ions accumulate on one plate while the negatives congregate on the other, thereby producing a Coulomb \underline{E} -field.

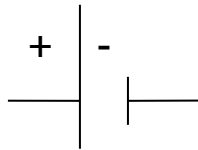

For historical reasons,

The output is called Electromotive force or EMF which is not a force at all. EMF is defined as the work done by an \underline{E} -field to move a unit charge and is measured in Volts, just like ΔV .

N.B. Inside a battery there are no mobile electrons, it is ions that move. Same is true for motion of charges through cell walls.

> **Apply now**

REDEFINE YOUR FUTURE
**AXA GLOBAL GRADUATE
 PROGRAM 2015**

redefining / standards 

agence.cdg. © Photonistop

13.1 Capacitor

A device used to store an \underline{E} -field. Usually consists of two terminals separated by air/vacuum or an insulator. One establishes a potential difference V between the terminals; charges $\pm Q$ appear on them and “trap” an \underline{E} -field inside the device. No charge ever flows inside a capacitor. The “size” of the device is called capacitance and is defined by the equation

$$C = \frac{Q}{V} \quad \text{[EFFECT / CAUSE]}$$

so, of course, the magnitude of C tells us how much charge the device will hold for a given V .

The unit of C is $\frac{\text{Coulomb}}{\text{Volt}}$ called a Farad (F) in honor of Faraday. 1 F is a very large unit. Most capacitors are in the range of $10^{-6} F (\equiv \mu F)$.

Examples

1. **Parallel Plates of Area A separated by d** , each plate has charge density $\sigma = \frac{Q}{A}$.

$$\begin{aligned} \vec{E} \text{ -field is } & \vec{E} = \frac{\sigma}{\epsilon_0} \hat{x} \quad [0 < x < d] \\ & \vec{E} = 0 \quad \text{at all other } x. \end{aligned}$$

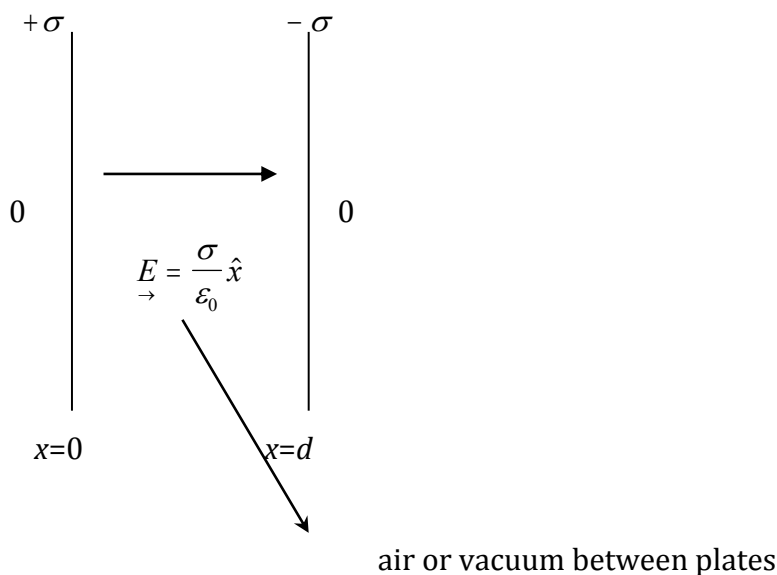

$$\Delta V = -\int_{\vec{E}} \vec{E} \cdot \Delta \vec{S} = -\frac{\sigma}{\epsilon_0} d \quad \text{so, } V = \left| \frac{\sigma}{\epsilon_0} d \right|$$

$$C = \frac{Q}{V} = \frac{\epsilon_0 A}{d}$$

$$\Delta V = -\vec{E} \cdot \Delta \vec{S} = -\frac{\sigma}{\epsilon_0} d \quad \text{so, } V = \left| \frac{\sigma}{\epsilon_0} d \right|$$

$$C = \frac{Q}{V} = \frac{\epsilon_0 A}{d}$$

$$2. \quad V = \frac{\sigma}{\epsilon_0} (d - l)$$

$$C = \frac{\epsilon_0 A}{d - l} \rightarrow (1)$$

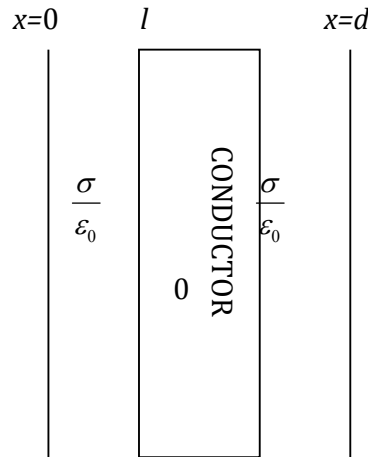

Put conductor of thickness l in

middle. Now

$\vec{E} = 0$ inside conductor

Empowering People. Improving Business.

BI Norwegian Business School is one of Europe's largest business schools welcoming more than 20,000 students. Our programmes provide a stimulating and multi-cultural learning environment with an international outlook ultimately providing students with professional skills to meet the increasing needs of businesses.

BI offers four different two-year, full-time Master of Science (MSc) programmes that are taught entirely in English and have been designed to provide professional skills to meet the increasing need of businesses. The MSc programmes provide a stimulating and multi-cultural learning environment to give you the best platform to launch into your career.

- MSc in Business
- MSc in Financial Economics
- MSc in Strategic Marketing Management
- MSc in Leadership and Organisational Psychology

BI NORWEGIAN BUSINESS SCHOOL

EFMD **EQUIS ACCREDITED**

www.bi.edu/master



Alternately, We have

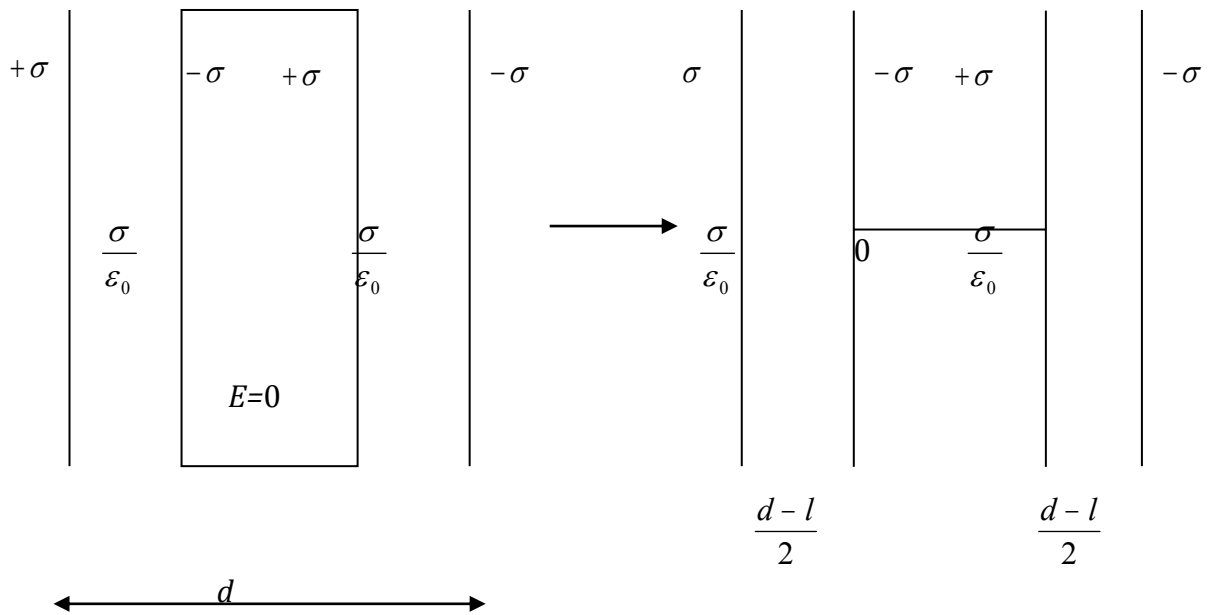

That is, as if two capacitors were in series, Each having $C_1 = C_2 = \frac{2\epsilon_0 A}{d-l}$ (2)

And comparing Eqs. (2) & (1) you see $\frac{1}{C} = \frac{1}{C_1} + \frac{1}{C_2}$

So when capacitors are connected in series, total equivalent capacitance is given by

$$\frac{1}{C_s} = \sum \frac{1}{C_i} \quad \leftarrow \text{SERIES CONNECTION (see below)}$$

3. **Dielectric between plates.** Dielectric consists of Dipoles. Dielectric is an insulator.

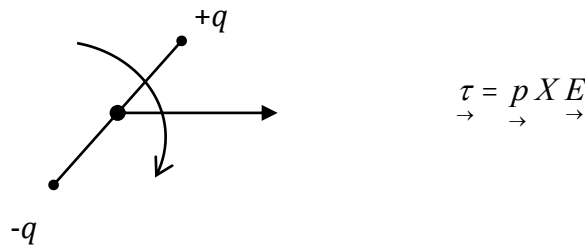

Every dipole feels a torque which makes it parallel to the E -field between the plates hence the system looks like what is shown on the next page:

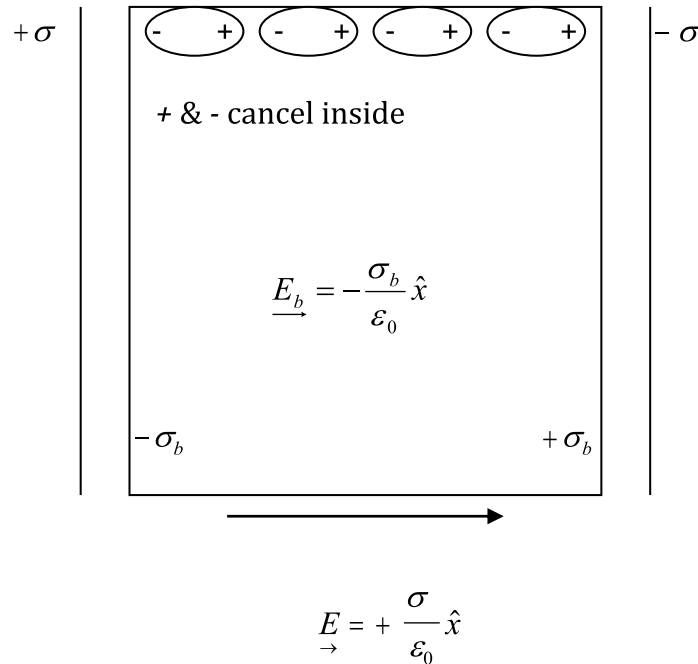

Dipole in \vec{E} -field experiences torque, which causes each Dipole to line up along \vec{E} .

On surfaces of dielectric charge sheets $+\sigma_b$ and $-\sigma_b$ appear.

\vec{E} -field inside dielectric is the sum of field due to charge on plates $\left[+\frac{\sigma}{\epsilon_0} \hat{x} \right]$ and that due to charge on surfaces of dielectric $\left[-\frac{\sigma_b}{\epsilon_0} \hat{x} \right]$.

Hence,

$$\vec{E}_\kappa = \frac{\sigma - \sigma_b}{\epsilon_0} \hat{x}$$

$$\frac{E_\kappa}{E} = \frac{\sigma - \sigma_b}{\sigma} = \frac{1}{\kappa}$$

κ = Dielectric Const. [N.B κ is always > 1].

$$\text{Now } V_\kappa = E_\kappa d = \frac{Ed}{\kappa} = \frac{\sigma d}{\epsilon_0 \kappa}$$

$$\text{So } C_\kappa = \frac{Q}{V_\kappa} = \frac{\sigma A \epsilon_0 \kappa}{\sigma d} = \frac{\kappa \epsilon_0 A}{d}$$

Capacitance is increased by factor κ .

Note: in both cases conductor of thickness l between plates or Dielectric of thickness d , potential difference is reduced but physics is totally different!

Next, put the two devices in a circuit:

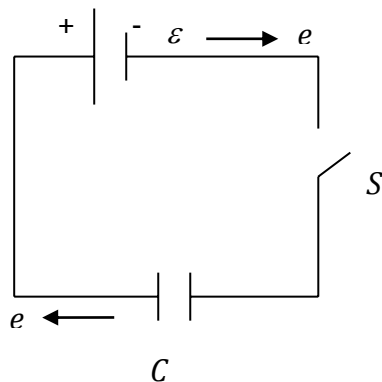

Note: the lines connecting the devices are perfect conductors and so under stationary conditions they must become equipotentials. That is if we close the switch S and wait for a while the Potential difference across C will become ϵ .

$$V = \epsilon$$

$$Q = \epsilon C$$

Need help with your dissertation?

Get in-depth feedback & advice from experts in your topic area. Find out what you can do to improve the quality of your dissertation!

[Get Help Now](#)



Go to www.helpmyassignment.co.uk for more info



So the capacitor plates now have $+Q$ (left) and $-Q$ (right). How did this happen? Clearly, the +ive plate of the battery pulled electrons from the left sheet of capacitor while the -ive plate pushed electrons on the right sheet. Effectively, start with $q=0$ on either sheet, transfer charge from one sheet to the other, so one becomes $-q$ & the other q [However, **no** flow of charge between capacitor plates]

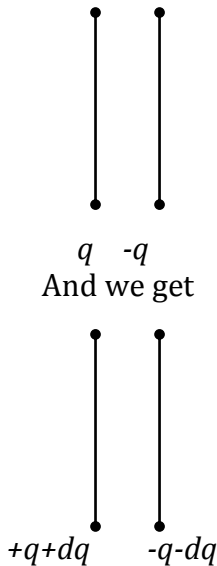

Making $V=q/c$

Now take Δq from rt. To Left. Work done will be

$$DW = \Delta q \frac{q}{C} \text{ area of rectangle. (next page picture)}$$

CONSERVATIVE FORCE: Work done is independent of the path.

To build up charge from 0 to Q you need area of Δ . This work is now $U_E = \frac{1}{2} \cdot Q(Q/C) = \frac{Q^2}{2C}$

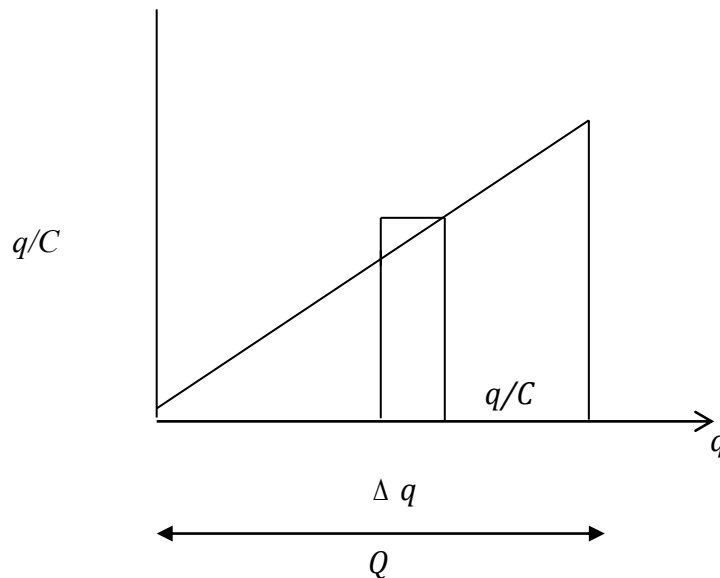

Where does this work go? Notice, space between plates is not empty; there is an \vec{E} -field in it. **This energy is energy is stored a potential energy in that \vec{E} -field.**

Apply it to ||-plate [air bet plates] $Q = \sigma A, C = \frac{\epsilon_0 A}{d}$

$$U_E = \frac{\sigma^2 A^2 d}{2\epsilon_0 A}$$

$$= \frac{1}{2} \epsilon_0 E^2 Ad \qquad E = \frac{\sigma}{\epsilon_0}$$

Energy density = $\frac{U_E}{vol} = \frac{U_E}{Ad} = \frac{1}{2} \epsilon_0 E^2$ this is like a “Pressure” $\eta_E = \frac{1}{2} \epsilon_0 E^2$

||-Plate [Dielectric]

$$U_E = \frac{Q^2}{2C_k} = \frac{\sigma^2 A^2 d}{2\kappa\epsilon_0 A}$$

$$= \frac{1}{2} \kappa\epsilon_0 E_k^2 Ad$$

$$\eta_E(k) = \frac{1}{2} \kappa\epsilon_0 E_k^2 Ad$$

Next, consider the Expt: two identical capacitors.

First, put charges $\pm Q$ on one $U_E = \frac{Q^2}{2C}$

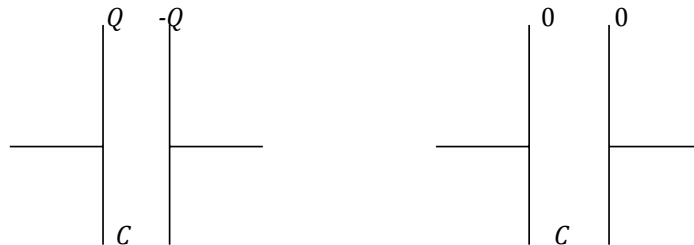

Next, connect left-to-left, right to right to make Equipotentials, now charge will be $\pm \frac{Q}{2}$ on each. Total

$$\text{Energy } U_E = \frac{2 \cdot 1}{2} \left(\frac{Q}{2}\right)^2 \cdot \frac{1}{C} = \frac{Q^2}{4C}$$

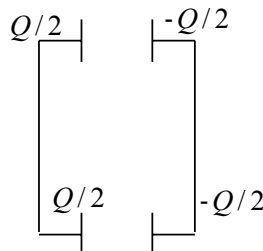

Important [What happened to half of the energy? In the second half of the experiment charge was transported from one set of plates to the other. This experiment tells us that it costs energy to transport charge through a conductor. This leads us to our third device.

13.1 Resistor

First we define current $I = \lim_{\Delta t \rightarrow 0} \frac{\Delta Q}{\Delta t}$ as the amount of charge flowing per second

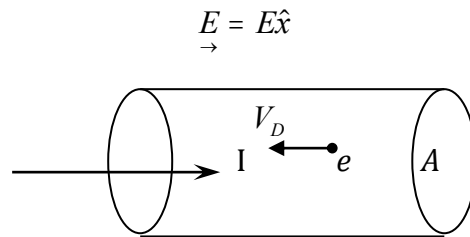

To calculate quantity of charge flowing per second, note that cross-sectional area is A and since only electrons are mobile one can write $I = n_e(-e)A(-V_D)$ in Coulomb/sec or Ampere (unit of current)

where $n_e = \#$ of mobile electrons/ m^3

$$-e = 1.6 \times 10^{-19} C$$

$$V_D = \text{drift speed}$$

Notice: Direction of I is opposite to that of electron drift.

Brain power

By 2020, wind could provide one-tenth of our planet's electricity needs. Already today, SKF's innovative know-how is crucial to running a large proportion of the world's wind turbines.

Up to 25 % of the generating costs relate to maintenance. These can be reduced dramatically thanks to our systems for on-line condition monitoring and automatic lubrication. We help make it more economical to create cleaner, cheaper energy out of thin air.

By sharing our experience, expertise, and creativity, industries can boost performance beyond expectations. Therefore we need the best employees who can meet this challenge!

The Power of Knowledge Engineering

Plug into The Power of Knowledge Engineering.
Visit us at www.skf.com/knowledge

SKF

Recall: $V_D \cong 10^{-4} m/s$. While $V_{rms} \cong 10^5 m/s$ at 300K. This is because ions are stationary and act as scattering centers. Electron has a very tortuous path so although the speed between collisions is high the entire electron “cloud” drifts rather slowly.

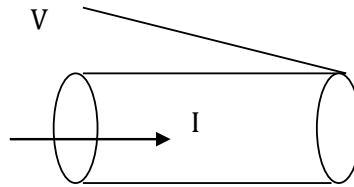

Since transport costs energy, potential must drop. Hence, definition of resistance

$$R = \frac{V}{I}$$

For a particular piece of conductor $R = \frac{\rho l}{A}$

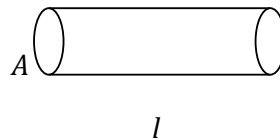

Unit of R is $\frac{Volt}{Amp}$

Called Ohm (Ω)

l =length, A = cross-section

ρ = resistivity (material property) $\rightarrow (\Omega - m)$

[cf. conduction of heat $\frac{DQ}{\Delta t} = -kA \frac{\Delta T}{\Delta x}$]

$$I = \frac{V}{R} = \frac{\Delta Q}{\Delta t} = \frac{VA}{\rho l} = \sigma A \frac{V}{l} \quad \sigma = \text{electrical conductivity}$$

It is instructive to write

$$I = \vec{J} \bullet \vec{A} \quad \vec{J} = \text{current density vector}$$

and we know that

$$E = \frac{V}{l}$$

so $\vec{J} = \sigma \vec{E}$

That is, if you apply an \vec{E} -field to a conductor it responds by setting up a current density proportional to E , the proportionality factor being the conductivity (electrical).

13.3 Electrical Conductivity

We have learnt that the Electrical Current is

$$I = n_e e A V_D$$

giving current density

$$\underline{J} = n_e e \underline{V}_D$$

Where V_D is the drift speed of the electrons and for a typical copper wire carrying a current of 1amp, V_D is about $10^{-4} m/s$ whereas at room temperature the thermal speed of the electron is $10^5 m/s$. This huge reduction occurs because the ions whose mass is several thousand time larger are essentially at rest so that when an electron hits an ion it bounces right back. Between collisions.



What do you want to do?

No matter what you want out of your future career, an employer with a broad range of operations in a load of countries will always be the ticket. Working within the Volvo Group means more than 100,000 friends and colleagues in more than 185 countries all over the world. We offer graduates great career opportunities – check out the Career section at our web site www.volvogroup.com. We look forward to getting to know you!

VOLVO
AB Volvo (publ)
www.volvogroup.com

VOLVO TRUCKS | RENAULT TRUCKS | MACK TRUCKS | VOLVO BUSES | VOLVO CONSTRUCTION EQUIPMENT | VOLVO PENTA | VOLVO AERO | VOLVO IT
VOLVO FINANCIAL SERVICES | VOLVO 3P | VOLVO POWERTRAIN | VOLVO PARTS | VOLVO TECHNOLOGY | VOLVO LOGISTICS | BUSINESS AREA ASIA

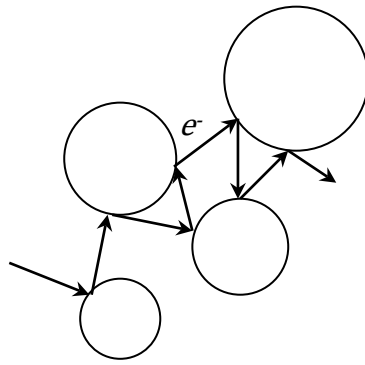

$$\vec{E} = -E\hat{x}$$

The applied \vec{E} field causes the drift, so it acts effectively only during the time interval τ between two collisions.

Force on electron $\underline{F}_E = eE\hat{x}$

Since it acts for time τ the electron gets an impulse

$$\underline{P} = eE\tau \hat{x}$$

And this gives rise to V_D so for an electron of mass m

$$mV_D = eE\tau$$

$$V_D = \frac{eE\tau}{m}$$

and current density

$$J = n_e \frac{e^2 E \tau}{m}$$

We have shown that

$$J = \sigma E$$

So the conductivity

$$\sigma = \frac{n_e e^2 \tau}{m}$$

Which is the famous Drude formula. At 300K in copper, $\tau \sim 10^{-14}$ sec which tells you that the collisions are extremely frequent. Further, although each collision is close to being elastic the net loss of energy in transporting charge through a conductor is non-zero and that causes resistance.

13.4 Multiple Capacitors

If there are more than one capacitors, then they can be connected either in

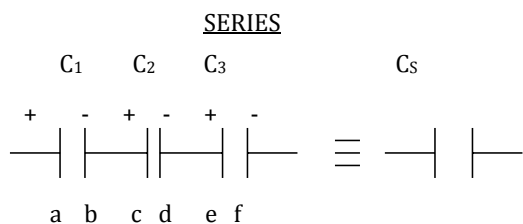

In this case all plates carry the same charge $\pm Q$

However, the potentials add

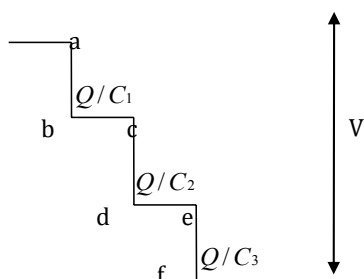

Clearly,

$$V = V_1 + V_2 + V_3$$

$$= \frac{Q}{C_1} + \frac{Q}{C_2} + \frac{Q}{C_3}$$

So to replace C_1, C_2, C_3 by a single capacitor C_s

$$V = \frac{Q}{C_s} = \frac{Q}{C_1} + \frac{Q}{C_2} + \frac{Q}{C_3}$$

$$\frac{1}{C_s} = \Sigma \frac{1}{C_i}$$

So Rule Is

For Series Q is common

giving $\frac{1}{C_s} = \Sigma \frac{1}{C_i}$

V 's add

For Parallel V is Common

giving $C_p = \Sigma C_i$

Q 's add

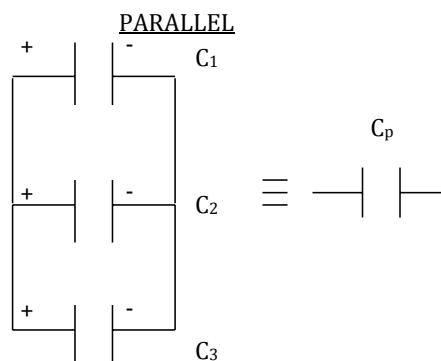

The "lines are equipotentials so all positive plates are at the same potential and similarly all negative plates are at the same potential. Hence, charges are

$$Q_1 = C_1V$$

$$Q_2 = C_2V$$

$$Q_3 = C_3V$$

And replacing C_1, C_2, C_3 by a single capacitor

$$C_pV = C_1V + C_2V + C_3V$$

$$C_p = \Sigma C_i$$

Example

What is C_{AB} ?

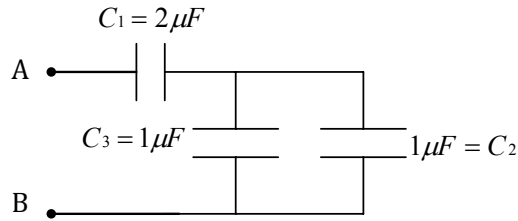

C_2, C_3 in parallel

$$C_4 = (1 + 1)\mu F = 2\mu F$$

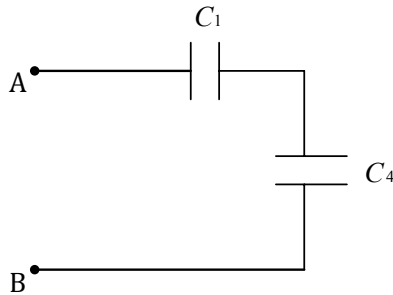

Now C_1, C_4 in series

$$\frac{1}{C_5} = \frac{1}{C_1} + \frac{1}{C_4} = \frac{1}{2} + \frac{1}{2}$$

$$C_{AB} = C_5 = 1\mu F$$

gaiteye
Challenge the way we run

EXPERIENCE THE POWER OF FULL ENGAGEMENT...

**RUN FASTER.
RUN LONGER..
RUN EASIER...**

**READ MORE & PRE-ORDER TODAY
WWW.GAITEYE.COM**

113.5 Multiple Resistors

A resistor is drawn as

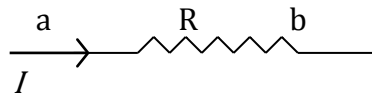

so if you establish a current I , the potential drop from a to b is $V_{ab} = IR$.

If you have more than one resistor, you can connect them in

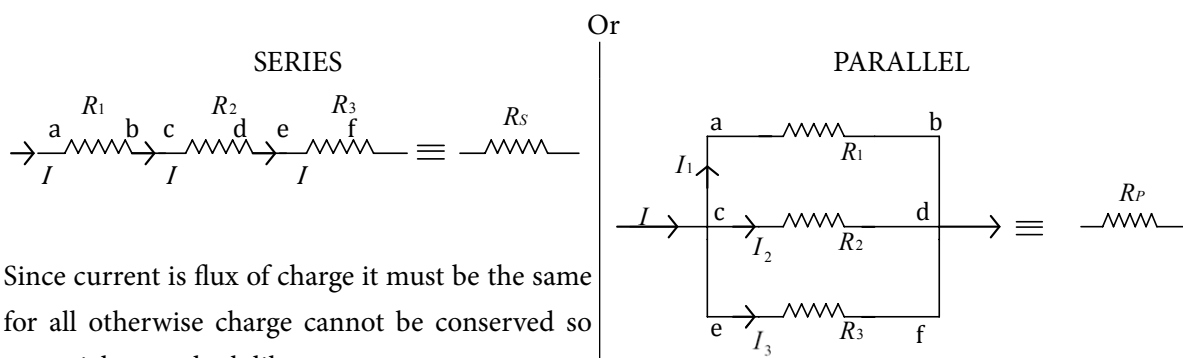

Since current is flux of charge it must be the same for all otherwise charge cannot be conserved so potentials must look like

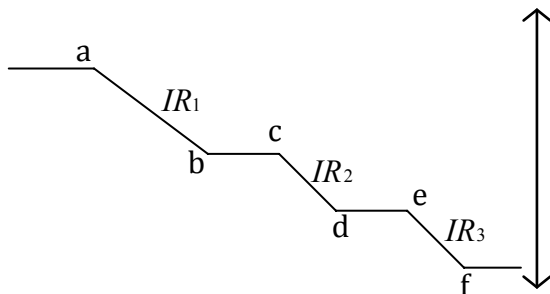

$$V_{a-f} = R_1 + R_2 + R_3$$

and if you replace them with a single resistor

R_s it must satisfy

$$V - R_s = I(R_1 + R_2 + R_3)$$

Or

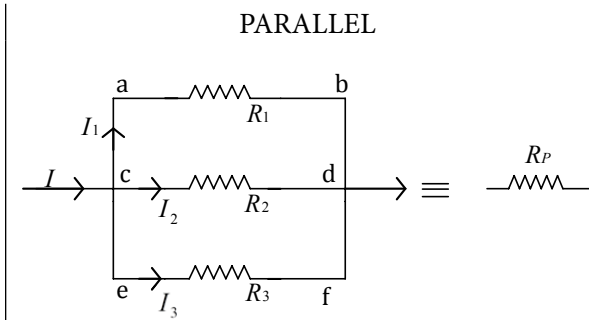

First we note that change of potential is independent of path so

$$V_{ab} = V_{cd} = V_{ef} = V$$

Current is flux of charge and charge is conserved

so $I_1 + I_2 + I_3 = I$

or $\frac{V}{R_1} + \frac{V}{R_2} + \frac{V}{R_3} = \frac{V}{R_p}$

hence $\frac{1}{R_p} = \sum \frac{1}{R_i}$

so $R_S = \Sigma R_i$

So the rule is:

For Series I is common V 's add $R_S = \Sigma R_i$

For parallel V is common I 's add $R_p^{-1} = \Sigma R_i^{-1}$

Example

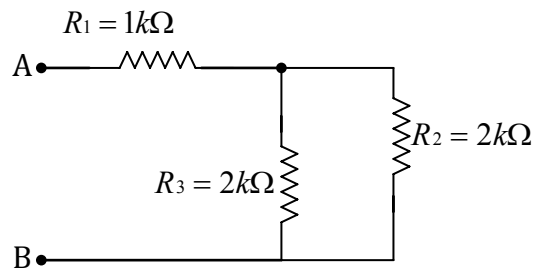

R_2 and R_3 are in parallel so

$$\frac{1}{R_4} = \frac{1}{R_2} + \frac{1}{R_3}$$

$$= \left(\frac{1}{2} + \frac{1}{2} \right) (k\Omega)^{-1}$$

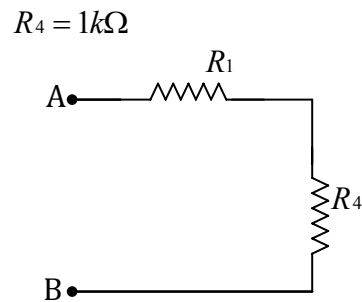

R_1 and R_4 are in series so

$$R_{AB} = R_1 + R_4 = (1+1)k\Omega = 2k\Omega$$

14 Dc-Circuits: Battery + Resistors + Capacitors

14.1 Ideal Battery + Resistor

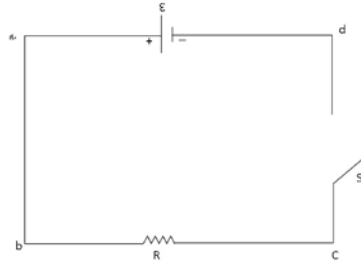

When the switch is closed current will flow counter-clockwise outside battery and from - to + inside battery

[Note: Current consists of electrons outside battery and ions inside it]

This e-book
is made with
SetaPDF



PDF components for PHP developers

www.setasign.com



The potentials at various points are

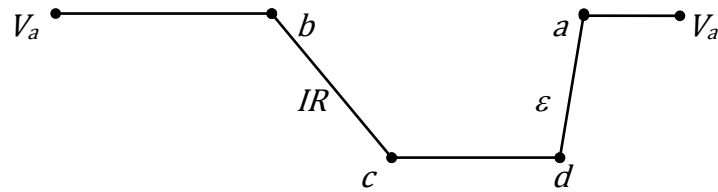

clearly,

$$IR = \varepsilon$$

$$I = \frac{\varepsilon}{R}$$

Power absorbed in resistor:

Each electron loses eV Joules going from b to c

$$\# \text{ electrons per sec } \frac{\Delta n}{\Delta t}$$

$$P_w = \frac{\Delta n}{\Delta t} eV = IV$$

$$P_w = I^2 R = \frac{V^2}{R}$$

$$\frac{|e|\Delta n}{\Delta t} = \frac{\Delta q}{\Delta t} = I$$

14.2 Real Battery + Resistor

Now there is power absorbed as charge travels inside the battery, we represent it by adding “ r ” to the circuit

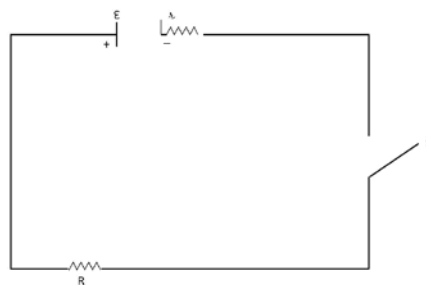

Now when switch closed, current is:

$$I = \frac{\mathcal{E}}{R + r}$$

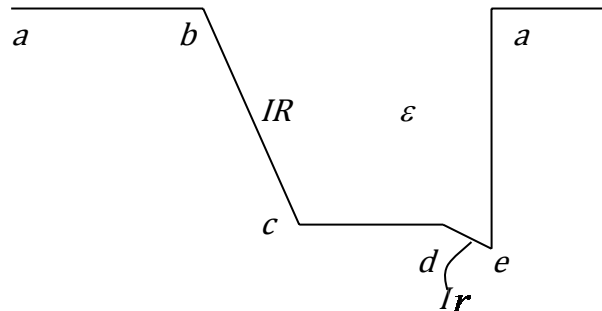

$$\text{Power Absorbed } P_w = \left(\frac{\mathcal{E}}{R + r} \right)^2 R$$

And if you vary R , P_w will go to zero both when $R \ll r$ or $R \gg r$

P_w is maximum when $R = r$.

General Rule:

Maximum power $\left[\frac{\mathcal{E}^2}{4r} \right]$ is delivered to load when load resistance is equal to the internal resistance of the generator.

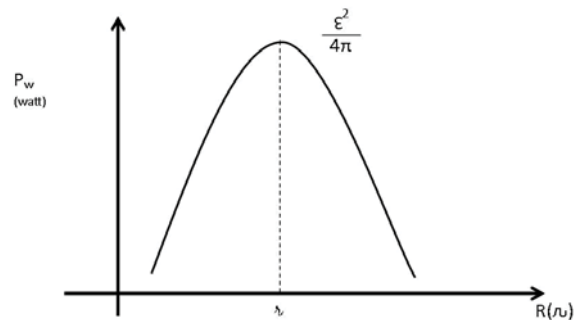

14.3 Next, put all 3-devices together in a Circuit:

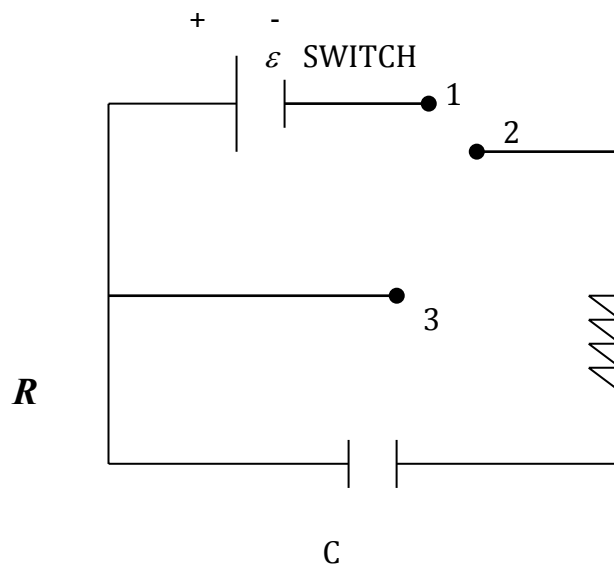

At $t=0$, connect 1 to 2: charge will flow from battery to capacitor plates.

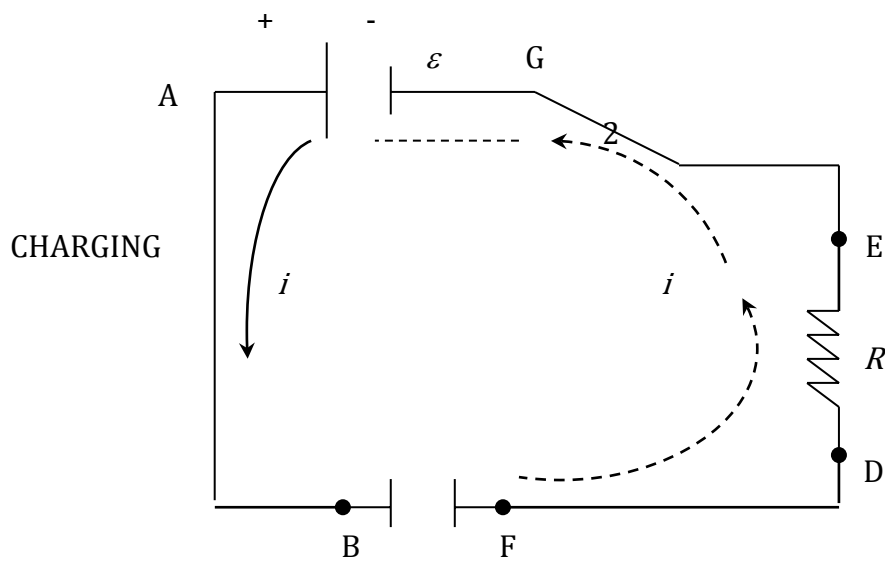

NOTICE NO CURRENT IN CAPACITOR.

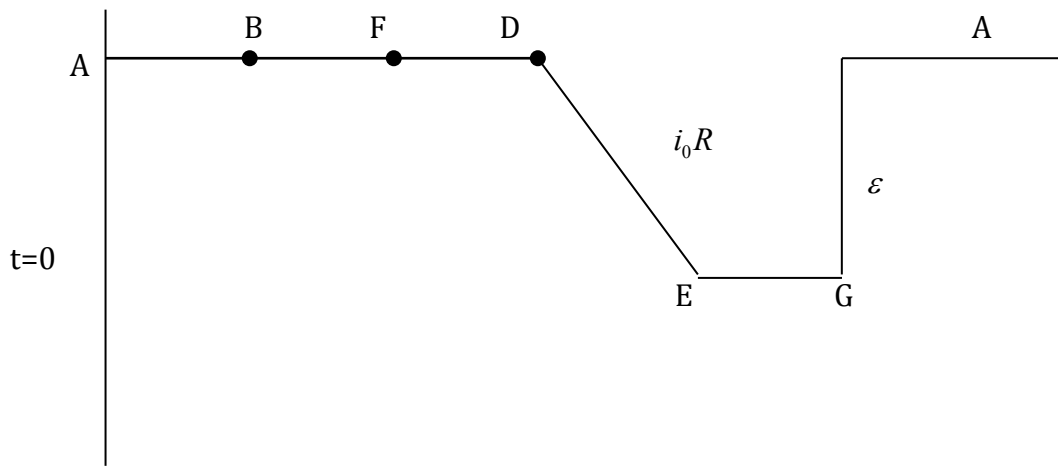

So $i_0 = \frac{\epsilon}{R}$

That is, R limits the maximum current that can flow so it will take time to build up charge on C . a little later C has $+q$ $-q$, $V_C = \frac{q}{C}$, and the Potential becomes

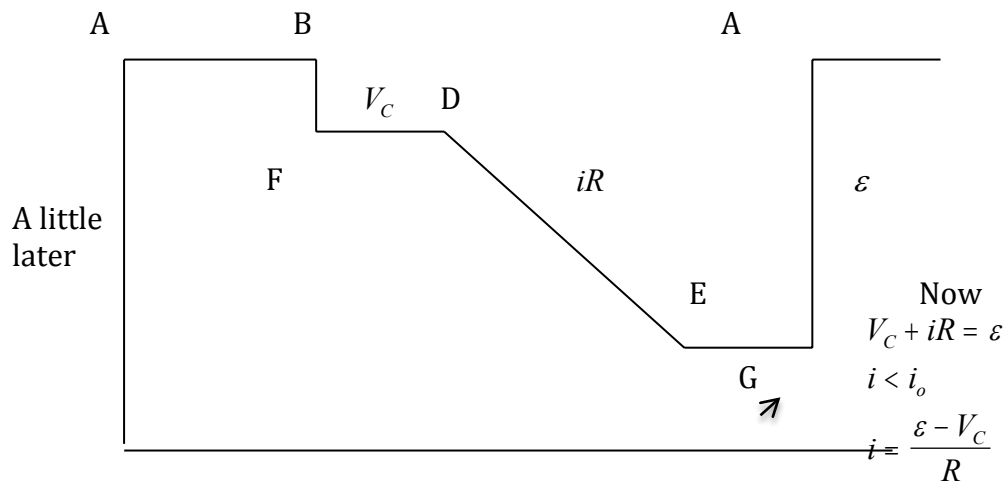

Eventually $q \rightarrow C\varepsilon$

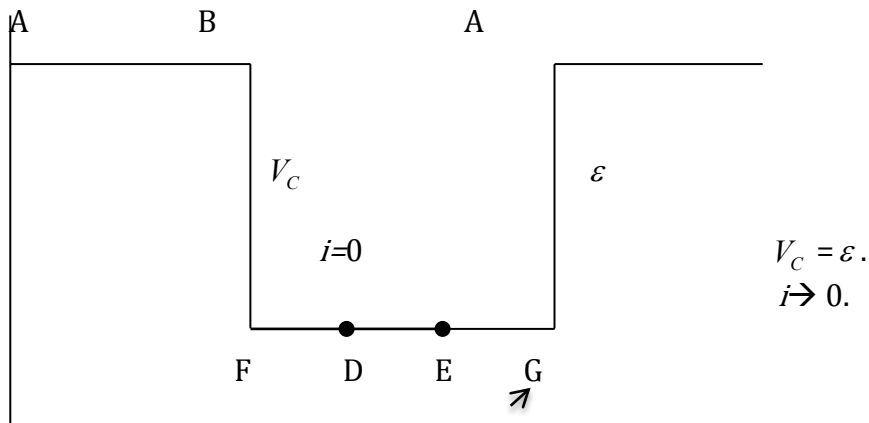

www.sylvania.com

We do not reinvent the wheel we reinvent light.

Fascinating lighting offers an infinite spectrum of possibilities: Innovative technologies and new markets provide both opportunities and challenges. An environment in which your expertise is in high demand. Enjoy the supportive working atmosphere within our global group and benefit from international career paths. Implement sustainable ideas in close cooperation with other specialists and contribute to influencing our future. Come and join us in reinventing light every day.

Light is OSRAM

OSRAM SYLVANIA



Mathematically it can be proved that:

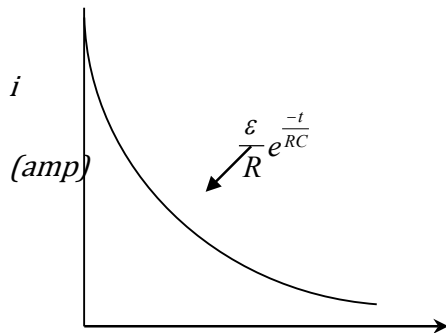

time (see)

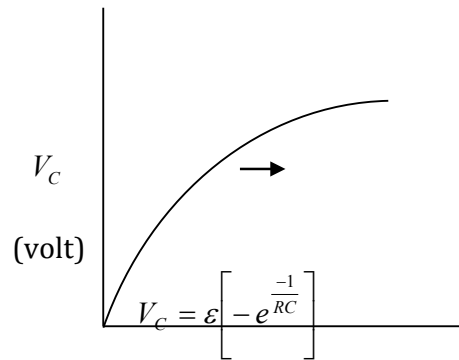

time (see)

So now $V_C = \epsilon$, $i=0$

Switch from 2 \rightarrow 1 to 2 \rightarrow 3. circuit is below

Start clock again

DISCHARGING: No battery in circuit current is due to capacitor's stored charge (E -field) \rightarrow

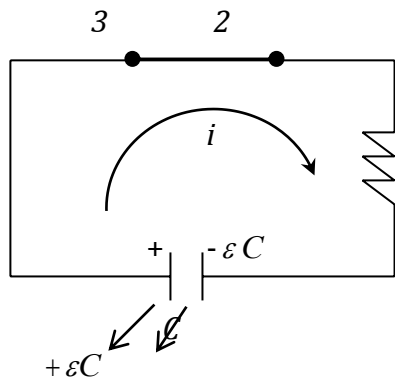

current flows in opposite direction
 R

NO CURRENT IN CAPACITOR

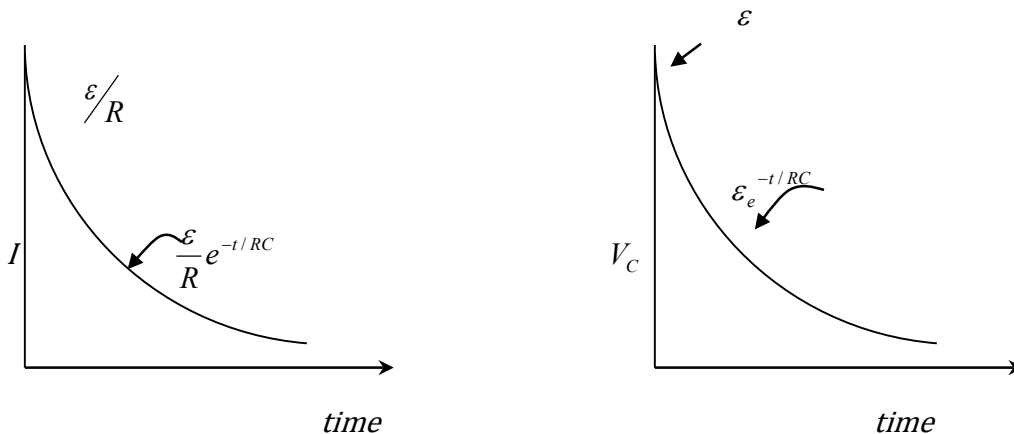

CHARACTERISTIC TIME $\tau = RC!!!$

$$R = \frac{V}{I} \Rightarrow \frac{VT}{Q}$$

$$C = \frac{Q}{V}$$

$$\text{So, } RC \Rightarrow \frac{Q}{V} \cdot \frac{VT}{Q} \Rightarrow T$$

RC has dimensions of time!

Process involves transference of charge [from battery to C during charging and from one terminal of C to the other during discharging]. R controls rate of flow. C controls amount of Q to be transferred for a given ϵ .

14.3 Kirchoff’s Rules: Physical Basis

Loop Rule: Change of potential between two points is independent of the path because potential is derived from potential energy and the latter is defined for a **CONSERVATIVE** force so net change of potential on a closed loop must be zero.

$$\sum_{LOOP} \Delta V_i \equiv 0$$

Potential at any point is unique!

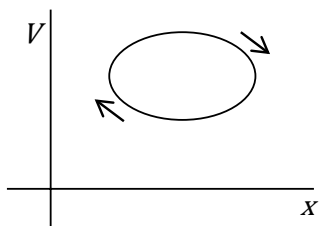

[Recall that in a Thermodynamic cyclic process $dU = 0$, Thermodynamic potential (Internal energy)]

Junction Rule: Flow of charge is continuous, i.e., apart from what is involved in setting up the original field to drive a current, there can be no continuous accumulation (depletion) of charge at a junction, consequently,

Current is flux of charge, charge is conserved hence charge flow per sec. out of junction must be equal charge flow into junction per sec.

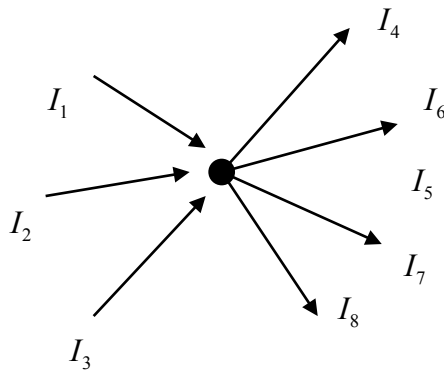

$$\sum I_{out} = \sum I_{in}$$



Discover the truth at www.deloitte.ca/careers

Deloitte.

© Deloitte & Touche LLP and affiliated entities.



15 Fields: Gravitational, Coulomb \underline{E} , \underline{B}

\underline{G} : A mass m located in a Gravitational field feels a force $\underline{F}_G = m \underline{G}_F$

Measure \underline{F}_G , map out \underline{G}_F .

A mass M located at the origin creates a \underline{G}_F

$$\underline{G}_F = -\frac{GM}{r^2} \hat{r}$$

consequently, $\sum_c \underline{G}_F \bullet \underline{\Delta A} = -4\pi G \Sigma M_i$

FLUX OF \underline{G}_F Through a closed surface is determined solely by the masses enclosed by the surface.

\underline{E} : A charge q located in an \underline{E} -field feels a force $\underline{F}_E = q \underline{E}$.

Measure \underline{F}_E , map out \underline{E} .

A stationary charge Q located at $r=0$ generates a coulomb \underline{E} -field

$$\underline{E} = \frac{Q}{4\pi\epsilon_0 r^2} \hat{r}$$

[+Q (source), -Q (sink)] consequently, $\sum_c \underline{E} \bullet \underline{\Delta A} = \frac{1}{\epsilon_0} \Sigma Qi$

FLUX OF \underline{E} THROUGH A CLOSED SURFACE IS DETERMINED SOLELY BY THE CHARGES ENCLOSED BY THE SURFACE. ϵ

The Devices resulting from this are: (i) Battery 

(ii) Capacitor $C = \frac{Q}{V}$ which leads to energy density $\eta_E = \frac{1}{2} \epsilon_0 E^2$

That is the energy contained in $1m^3$ vol. of \underline{E} -field

(iii) Resistor $R = \frac{V}{I}$ which leads to $\underline{J} = \sigma \underline{E}$, because $I = \underline{J} \bullet \underline{A}$

That is, if you apply \underline{E} to a Conductor it responds by setting up a current density \underline{J} whose magnitude is determined by the electrical conductivity σ .

To Summarize: if a stationary mass experiences a force when there is no visible agency applying the force, the mass must be located in a Gravitational, \underline{G} field. If a stationary charge experiences a force when there is no visible agency applying the force, the charge must be located in an Electric \underline{E} -field.

Next, we want to talk about a Magnetic Field: \underline{B} -field. The presence of a \underline{B} -field is revealed only if we have a charge q which is moving. Supposing there is a region of space where a uniform \underline{B} -field is present. If we take a charge q and give it a velocity \underline{v} we will find the following features of the force it experiences

- 1) The force is directly proportional to q and reverses with the sign of q .
- 2) The force is directly proportional to v .
- 3) It is always perpendicular to \underline{v} .
- 4) It is directly proportional to B .
- 5) There is one direction of \underline{v} where force is zero no matter how large \underline{B} is.

All of these findings can be incorporated in a single expression for the force, namely

$$\underline{F}_B = q[\underline{v} \times \underline{B}]$$

And by definition of the vector product we know that magnitude of

$$F_B = qvB \sin(\underline{v}, \underline{B})$$

So this force is maximum when $\underline{v} \perp \underline{B}$ and zero if $\underline{v} \parallel \underline{B}$.

Also direction of \underline{F}_B is given by the right-hand rule

$$q\underline{v} \parallel \text{Thumb} \quad \underline{B} \parallel \text{Fingers} \quad \underline{F}_B \perp \text{Palm}$$

The new field \underline{B} has dimensions $MT^{-1}Q^{-1}$, the unit is TESLA and it is a VECTOR.

Examples

q positive

q negative

$t = 0$

$$\underline{v} = v\hat{x}$$

$$t = 0 \quad \underline{v} = v\hat{x}$$

$$\underline{B} = B\hat{y}$$

$$\underline{B} = B\hat{y}$$

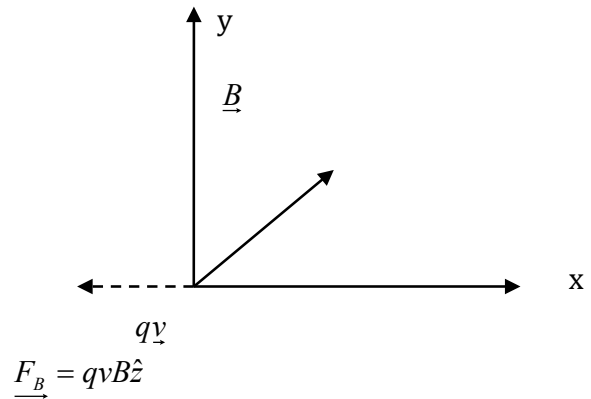
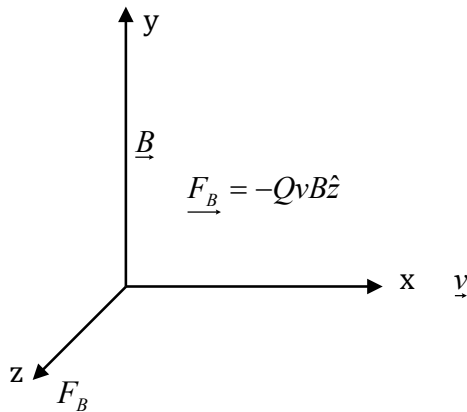

So, if a moving charge experiences a force which is **always** perpendicular to its velocity and there is no visible agency applying the force then the charge must be moving in a \underline{B} -field.

15.1 Problem I

At $t=0$, charge q is at the origin and has velocity $\underline{v} = v\hat{x}$. Turn on a field $\underline{B} = B\hat{y}$ immediately, it experiences \underline{F}_B along $-\hat{y}$. This makes \underline{v} turn, but \underline{F}_B turns also. Net result is as shown in Figure. q goes around in a circle $\underline{F}_B \perp \underline{v}$ always so Kinetic Energy is fixed, magnitude of \underline{v} does not change. Since $\underline{F}_B \perp \underline{v}$, \underline{F}_B cannot do work on q . Direction of \underline{v} changes magnitude of \underline{v} does not!

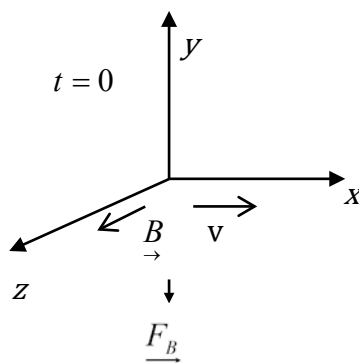

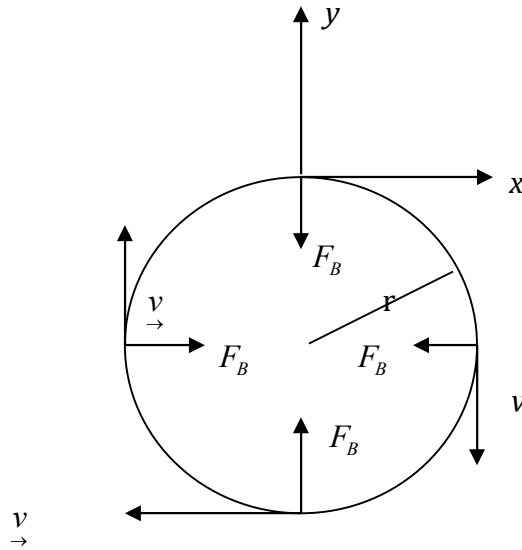

Particle moves under influence of $\vec{F}_B = -qv\hat{r}$ [v & B are \perp to one another]

Note: Plane of orbit \perp to \vec{B} field.

Note: Uniform circular motion needs a centripetal force.

SIMPLY CLEVER

ŠKODA



We will turn your CV into an opportunity of a lifetime



Do you like cars? Would you like to be a part of a successful brand? We will appreciate and reward both your enthusiasm and talent. Send us your CV. You will be surprised where it can take you.

Send us your CV on www.employerforlife.com



Click on the ad to read more

$$\vec{F}_C = \frac{-Mv^2}{r} \hat{r}$$

\vec{F}_B provides it

$$\vec{F}_B = \vec{F}_C \quad \text{so} \quad r = \frac{Mv}{qB}$$

angular velocity $\underline{\omega} = \frac{-qB}{m} \hat{z}$ (see picture above)

Note: ω independent of v .

15.2 Problem II

Force on Current Carrying conductor of length l ; Cross. Sec A , charge density n_e each electron feels

$$\vec{F}_B = (-e)[\underline{v}_D \times \underline{B}]$$

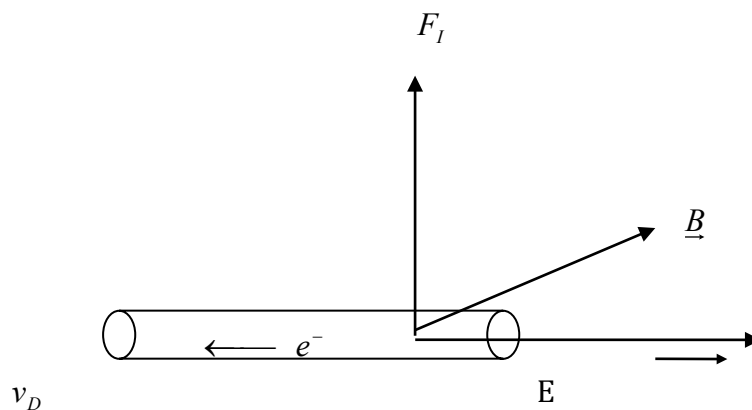

of electrons = $n_e A \Delta l$

so total force on conductor $\underline{F}_l = n_e (-e) A \Delta l [\underline{v}_D \times \underline{B}] = I \underline{\Delta l} \times \underline{B}$

electrons constrained to move along Δl so $\underline{F}_l = n_e e A v_D [\underline{\Delta l} \times \underline{B}] = I \underline{\Delta l} \times \underline{B}$

15.3 Problem III

Rectangular loop of wire suspended in a \underline{B} -field with current in loop as shown, start with loop in xy -plane, at $t=0$.

$$\vec{F}_l = I l B \hat{z} \quad \text{on } OA$$

$$\vec{F}_l = -I l B \hat{z} \quad \text{on } O'A'$$

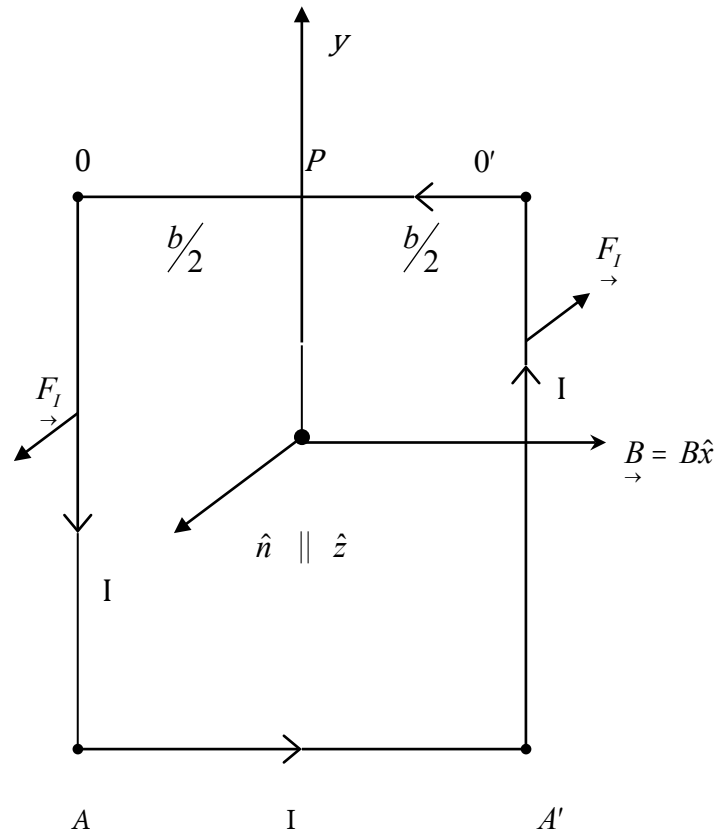

I joined MITAS because
I wanted **real responsibility**

The Graduate Programme
for Engineers and Geoscientists
www.discovermitas.com



Month 16

I was a construction
supervisor in
the North Sea
advising and
helping foremen
solve problems

Real work
International opportunities
Three work placements



 **MAERSK**



Net force is zero. However, torque is given by

$$\begin{aligned} \vec{\tau} &= I l B \frac{b}{2} \hat{y} + I l B \frac{b}{2} \hat{y} \\ &= I l B b \hat{y} \end{aligned} \tag{1}$$

Rotate (look from above)

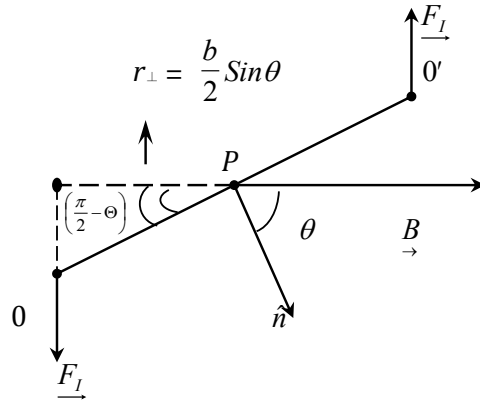

$$\begin{aligned} \vec{\tau} &= [\vec{r} \times \vec{F}] \\ \tau &= r_{\perp} F \end{aligned}$$

Note I and B still at right angles to one another, F_I does not change but now $r_{\perp} = \frac{b}{2} \sin \theta$. [Direction of \hat{n} also fixed by right hand rule] $\vec{\tau} = I l B b \sin \theta \hat{y}$ (2)

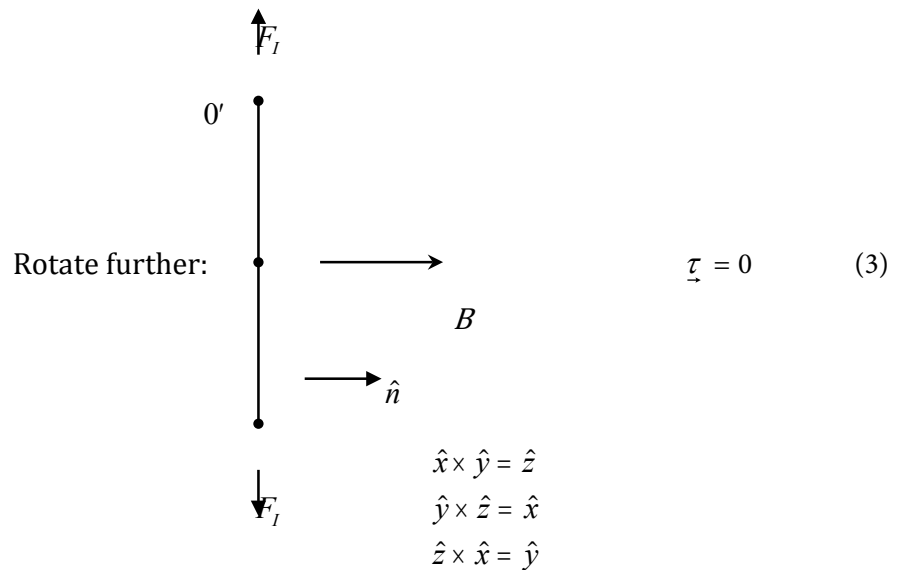

Equations (1), (2), (3) combine to give $\vec{\tau} = I l b \hat{n} \times \vec{B}$

Define Magnetic (Dipole) moment $\vec{\mu} = I l b \hat{n} = I A \hat{n}$

$$\vec{\tau} = \vec{\mu} \times \vec{B}$$

If the coil has N turns $\vec{\mu} = I A N \hat{n}$

Note: The top ($00'$) and bottom (AA') wires have equal and opposite Forces. They will make the coil out of shape but have no other effect.

The above discussion forms the basis of a dc Motor, It is best to look at it as follows. First, we establish I such that we have the situation.

$$\underline{\mu} = IA \hat{z}, \quad \underline{\tau} = \underline{\mu} \times \underline{B}$$

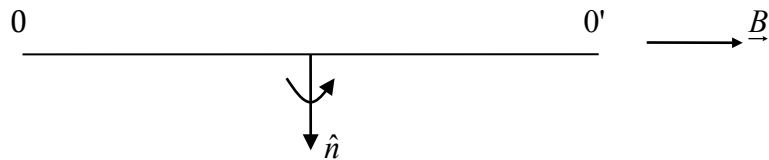

And the torque will cause the coil to turn counterclockwise until

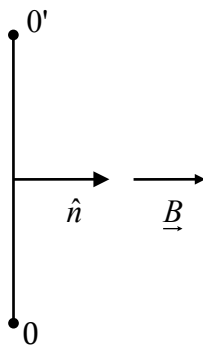

If we do not switch I the coil overshoots

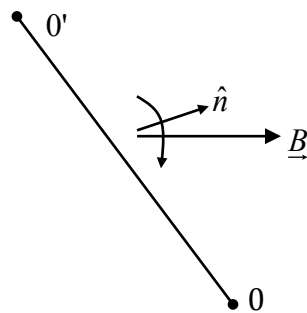

But now torque will bring it back toward \underline{B} (clockwise)

Therefore, in order to keep it going we reverse I and hence \hat{n} to give

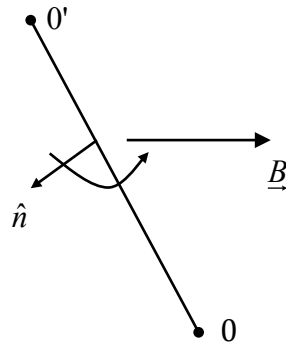

And the torque will turn \hat{n} toward \underline{B} , counter clockwise so for a dc motor we establish a current in a coil, suspended in a \underline{B} field, and free to rotate about an axis perpendicular to \underline{B} , and reverse the current every half cycle when $\hat{n} \parallel \underline{B}$ using a commutator and brushes.

Shown schematically along side. In actual motors, there are many current loops and commutators for smooth running.

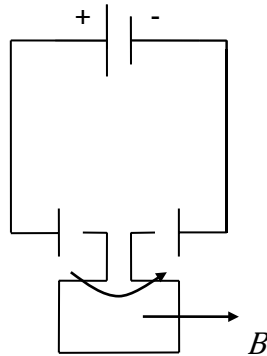

16 Generation of A \underline{B} Field

We have seen that a stationary charge experiences a force in an \underline{E} -field and a stationary charge generates a Coulomb \underline{E} -field. Now we know that a moving charge feels a force in a \underline{B} -field so it is natural to expect that a moving charge, such as a current in a conductor, will generate a \underline{B} -field. This is the content of the so-called Biot-Savart law. A current I in a conductor of length Δl will generate a \underline{B} -field at a point r away from the conductor given by the equation

$$\Delta \underline{B}(r) = \frac{\mu_0}{4\pi} I \frac{\Delta l \times r}{r^3}$$

Where $\mu_0 = 4\pi \times 10^{-7} \frac{T \cdot m}{A}$ is a universal constant. We will not use this equation in detail but, as shown next, it gives a very important clue as to the direction of $\underline{\Delta B}$.

ie business school

#1 EUROPEAN BUSINESS SCHOOL
FINANCIAL TIMES 2013

#gobeyond

MASTER IN MANAGEMENT

Because achieving your dreams is your greatest challenge. IE Business School's Master in Management taught in English, Spanish or bilingually, trains young high performance professionals at the beginning of their career through an innovative and stimulating program that will help them reach their full potential.

- Choose your area of specialization.
- Customize your master through the different options offered.
- Global Immersion Weeks in locations such as London, Silicon Valley or Shanghai.

Because you change, we change with you.

www.ie.edu/master-management | mim.admissions@ie.edu |

16.1 Cases Of Special Interest

Single current – I in a long wire: What can we say about \vec{B} -field at a distance r from the wire? Notice that $\Delta l \parallel \hat{y}$. And the vector $\Delta l \times \vec{r}$ is perpendicular to both Δl and \vec{r} so we can say that \vec{B} must curl around the wire.

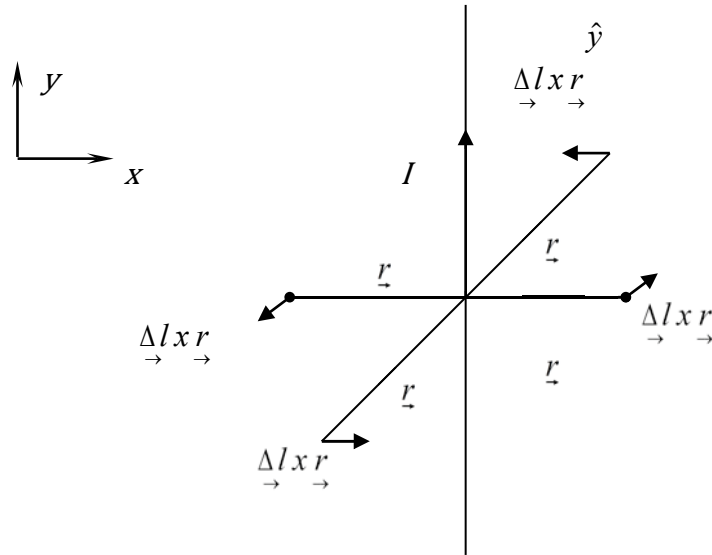

B

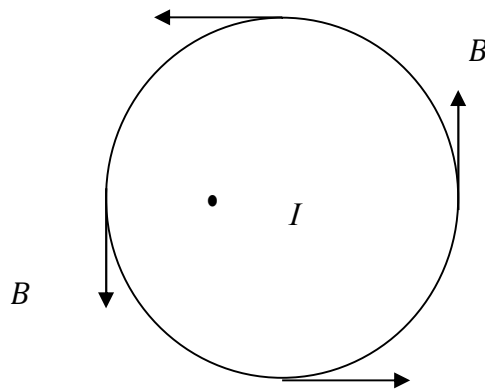

[I out of page]

Looking end on (see picture) we have cylindrical symmetry so \vec{B} can be a function of r only. It turns

out that $B = \frac{\mu_0 I}{2\pi r}$

so, $B = \frac{\mu_0 I}{2\pi r} \hat{\phi}$

Thus, \vec{B} is said to be Azimuthal, $\hat{\phi}$ is the direction which curls around I. [check with the sheet on right hand rules].

Next, take the wire and make a circular loop out of it, put it in xz -pl. with center at the origin. What is the \vec{B} -field at y or $-y$?

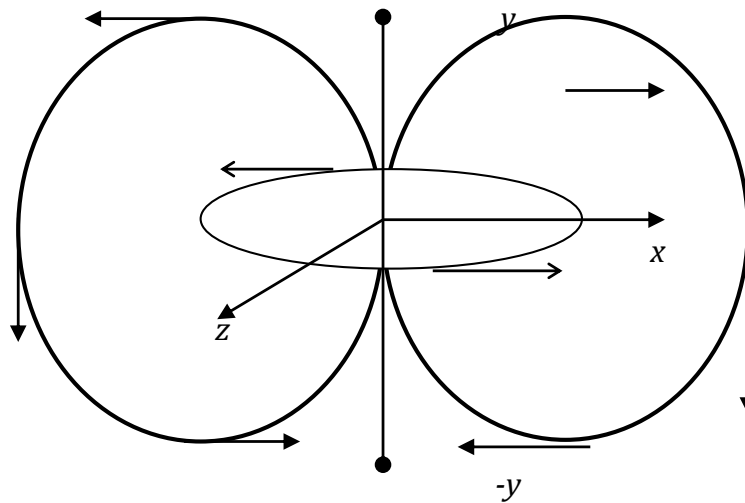

The \vec{B} -field lines are shown schematically, it turns out that

$$\vec{B}(y) = \vec{B}(-y) = \frac{\mu_0}{4\pi} \frac{2I\pi a^2}{(a^2 + y^2)^{3/2}} \hat{y}$$

STUDY AT A TOP RANKED INTERNATIONAL BUSINESS SCHOOL

Reach your full potential at the Stockholm School of Economics, in one of the most innovative cities in the world. The School is ranked by the Financial Times as the number one business school in the Nordic and Baltic countries.

Visit us at www.hhs.se



Once again, we encounter $IA \hat{n}$ so we can write using magnetic (dipole) moment

$$\vec{B}(y) = \frac{\mu_0}{4\pi} \frac{2\vec{\mu}}{(a^2 + y^2)^{3/2}}$$

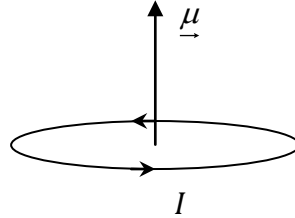

Far away from $\mu, y \gg a$

$$\vec{B}(y) = \frac{\mu_0}{4\pi} \cdot \frac{2\vec{\mu}}{y^3} \leftarrow \text{Magnetic Dipole}$$

Recall that for an Electric Dipole

$$\vec{p} = 2qa \hat{y}$$

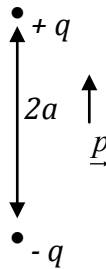

and the \vec{E} -field at y is

$$\vec{E}(y) = \frac{1}{4\pi\epsilon_0} \frac{4qay}{(y^2 - a^2)^2} \hat{y}$$

so that at $y \gg a$

$$\vec{E}(y) = \frac{1}{4\pi\epsilon_0} \frac{2\vec{p}}{y^3} \leftarrow \text{Electric Dipole}$$

Very Important! { However, there is a major difference here: along y the magnetic dipole has no “size” while electric dipole has length ($2a$). You can split the latter but not the former. This has the extremely important consequence that whereas electric-field lines start at $+q$ and end at $-q$, magnetic field lines close on themselves there is no beginning and no end.

16.2 Current-Current force

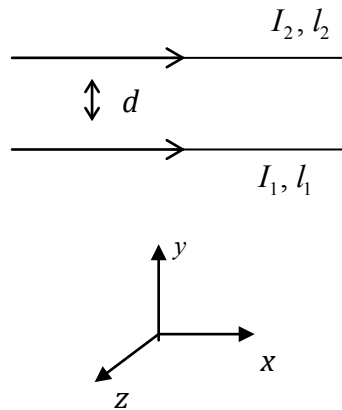

Two wires of lengths l_1, l_2 carry currents I_1, I_2 . Separation d along y , wires parallel to x . Force on I_2 due to I_1 . To calculate this first, write \vec{B}_1 at location of I_2

$$\vec{B}_1 = \frac{\mu_0 I_1}{2\pi d} \hat{z}$$

So I_2 is located in \vec{B}_1 : \vec{F}_{I_2} looks like

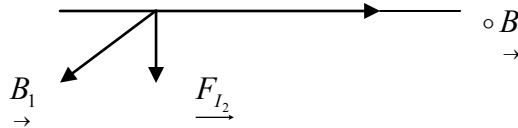

and is given by

$$\begin{aligned} \vec{F}_{I_1 I_2} &= I_2 \Delta \vec{l}_2 \times \vec{B}_1 \\ &= -\frac{\mu_0 I_1 I_2 \Delta l_2}{2\pi d} \hat{y} \end{aligned}$$

Force is attractive

Force on I_1 due to I_2

$$\begin{aligned} \vec{B}_2 &= \frac{-\mu_0 I_2}{2\pi d} \hat{z} \\ \vec{F}_{I_1 I_2} &= I_1 \Delta \vec{l}_1 \times \vec{B}_2 \\ &= \frac{\mu_0 I_1 I_2 \Delta l_1}{2\pi d} \hat{y} \end{aligned}$$

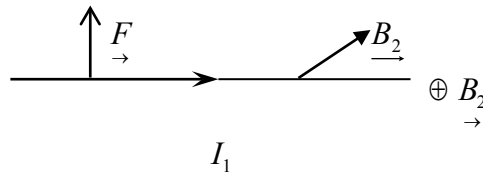

Force is attractive. If $l_1=l_2= 1\text{meter}$ the forces/meter $F_{\rightarrow} = \frac{-\mu_0 I_1 I_2}{2\pi d} \hat{d}$ are an action-reaction pair. The -sign with \hat{d} ensures force is attractive if I_1, I_2 parallel \rightarrow and repulsive when they are anti-parallel \rightarrow
 \leftarrow

Incidentally, this is a **very fundamental equation** as it is used to define the unit of current – The Ampere. That is,

If $I_1 = I_2 = 1\text{amp}$

And $d = 1\text{meter}$

Force per meter is $2 \times 10^{-7} N \left(\frac{\mu_0}{2\pi} \right)$

And the claim is that I should be regarded as a “DIMENSION” in place of Q. So we can write $L, T, M, \theta, [IT]$

rather than

L, T, M, θ, Q

17 Ampere's Law and its Applications

Consider the situation shown schematically in the diagram. Currents I_1, I_2, I_3, I_4, I_5 are flowing out of (\odot) or (\otimes) into the paper. The corresponding \vec{B} -fields swirl around their sources as shown. The main point is that the \vec{B} -field lines circulate around the currents. Choose a closed loop (L). Start at A , measure B , choose a small step Δl along the loop. Calculate Dot product (component of \vec{B} along Δl multiplied by Δl)

$$\vec{B} \cdot \underline{\Delta l} = B \Delta l \cos(\underline{B}, \underline{\Delta l})$$

$$\text{If } \underline{B} \perp \underline{\Delta l}, \underline{B} \cdot \underline{\Delta l} = 0.$$



#1
in eco-friendly attitude

**STUDY AT
LINKÖPING UNIVERSITY, SWEDEN**
RANKED AMONG TOP 50 UNIVERSITIES UNDER 50

Interested in Strategy and Management in International Organisations? Kick-start your career with a master's degree from Linköping University, Sweden.

→ **Click here!**

 **Linköping University**

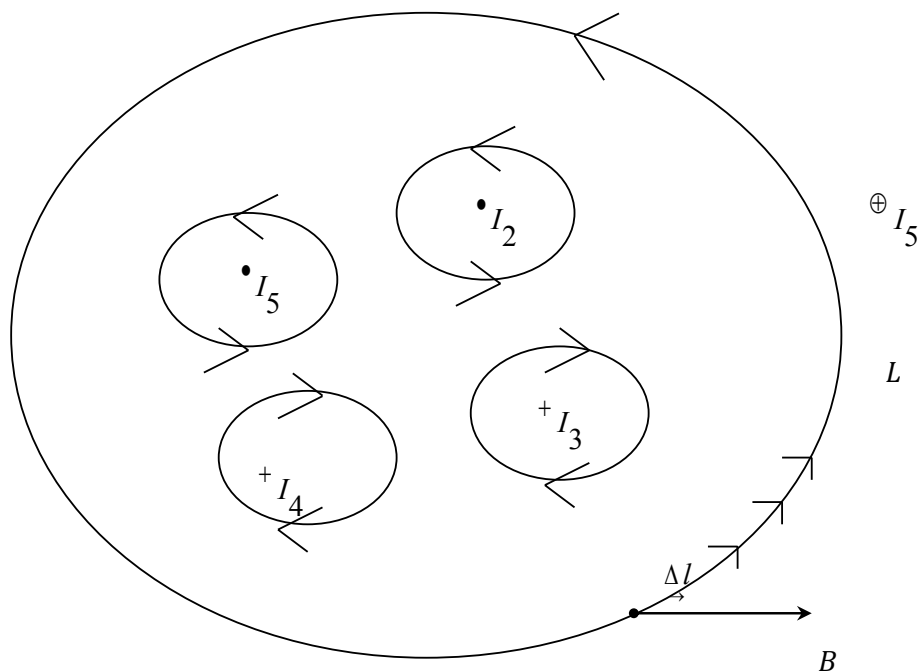

Repeat this calculation at every step as shown. $\underline{B}_1 \bullet \underline{\Delta l}_1 + \underline{B}_2 \bullet \underline{\Delta l}_2 + \underline{B}_3 \bullet \underline{\Delta l}_3 + \dots$
 Write out the sum

$$\sum_c \underline{B} \bullet \underline{\Delta l};$$

c: closed loop.

This sum is called the circulation of \underline{B} around a closed loop and Ampere’s Law says that it is determined solely by currents threading through the surface on which the loop is drawn & only currents within the loop contribute, i.e. exclude I_5 . The mathematical Equation is:

$$\sum_c \underline{B} \bullet \underline{\Delta l} = \mu_0 \sum I_i, \mu_0 = 4\pi \times 10^{-7} \frac{T \cdot m}{A}$$

In words, circulation of \underline{B} around a closed loop is proportional to the algebraic sum of the currents threading the loop surface on which the loop is drawn.

Note: As in the case of Gauss’ Law, Ampere’s Law gives circulation but not \underline{B} . To get \underline{B} you need high symmetry!

17.1 Applications

1) Single Current

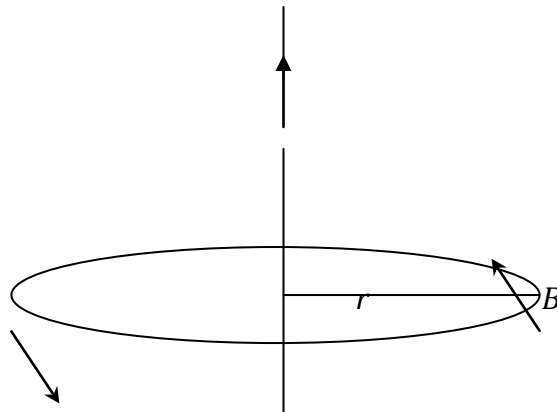

Single wire with current I , there is cylindrical symmetry so \vec{B} can be a function of r only & must encircle I . [\vec{B} and $\underline{\Delta l}$ are parallel to one another.]

Appropriate loop is circle of radius r centered on the wire

Hence,
$$\sum_c \vec{B} \cdot \underline{\Delta l} = B \cdot 2\pi r = \mu_0 I$$

so,
$$\vec{B} = \frac{\mu_0 I}{2\pi r} \hat{\phi}$$

as claimed previously

2) Next, we begin by showing that if the current is outside the loop it contributes nothing to the circulation. Choose $L M N O P Q$ with I at the center of the circles of radii r_1 , and r_2

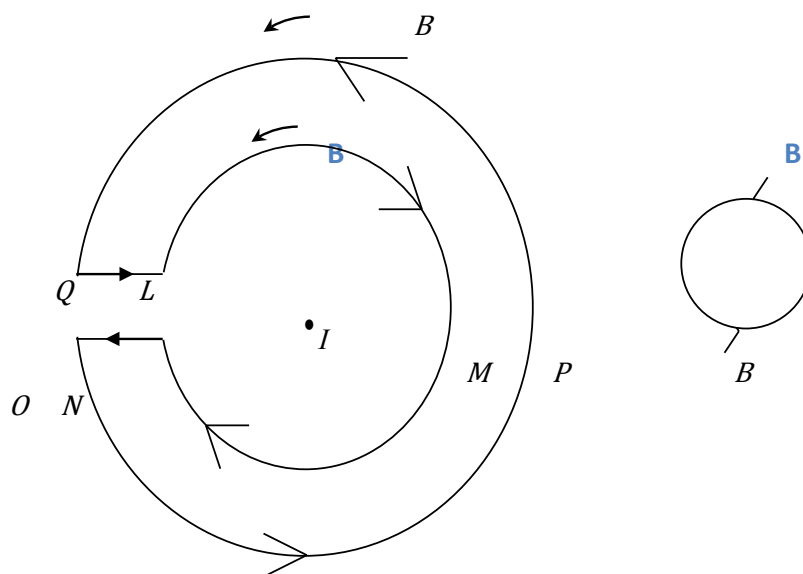

Start at L and go around the closed “loop”.

$$L \rightarrow M \rightarrow N \rightarrow O \rightarrow P \rightarrow Q \rightarrow L$$

First note that
$$\underline{B}(r_1) = \frac{\mu_0 I}{2\pi r_1} \hat{\Phi}$$

And
$$\underline{B}(r_2) = \frac{\mu_0 I}{2\pi r_2} \hat{\Phi}$$

$$\Sigma_C \underline{B} \cdot \underline{\Delta l} = \underbrace{\frac{\mu_0 I}{2\pi r_1} 2\pi r_1 \cos 180^\circ}_{L \rightarrow N} + \underbrace{0}_{N \rightarrow O} + \underbrace{\frac{\mu_0 I}{2\pi r_2} 2\pi r_2 \cos 0}_{O \rightarrow Q} + \underbrace{0}_{Q \rightarrow L} = 0$$

For $N \rightarrow O$ and $Q \rightarrow L$, $\underline{B} \perp \underline{\Delta l}$ hence $\underline{B} \cdot \underline{\Delta l} = 0$.

“I studied English for 16 years but...
...I finally learned to speak it in just six lessons”

Jane, Chinese architect



ENGLISH OUT THERE

Click to hear me talking before and after my unique course download



3)

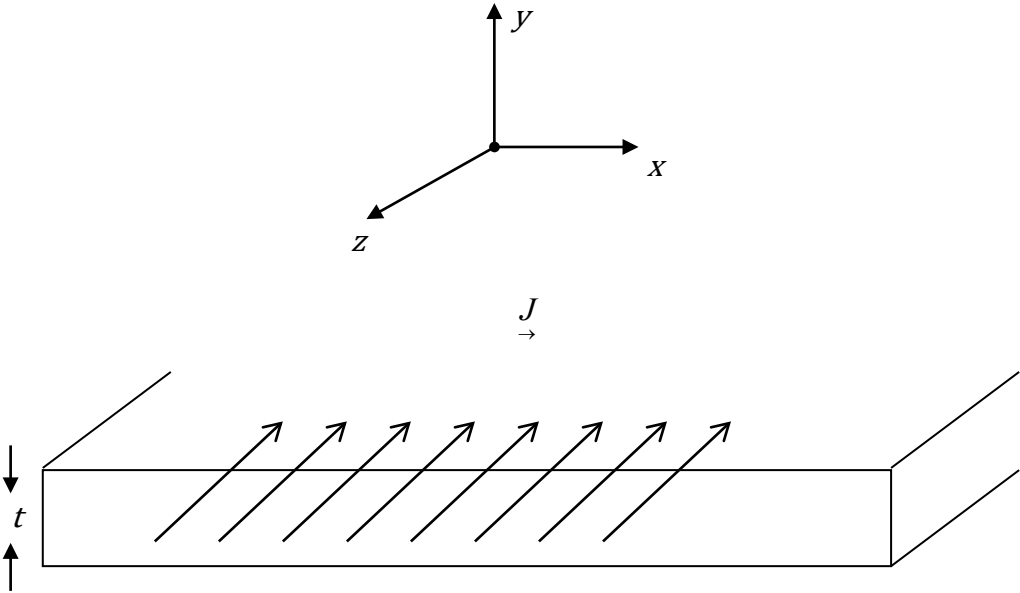

At $y=0$ there is a Current sheet of thickness t carrying current density $\vec{J} = -J\hat{z}$. Looking at it end-on we see sources of \vec{B} as

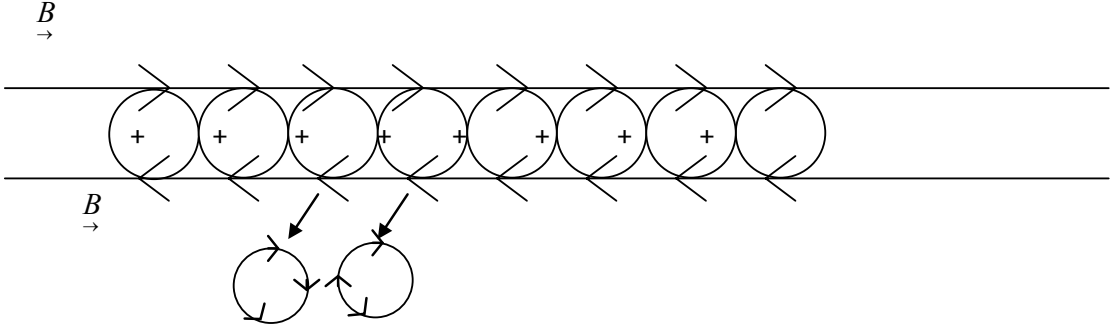

and we see that y -components of \vec{B} cancel out. $\vec{B} \parallel \hat{x}$ survives. Let us take loop of width l and height h .

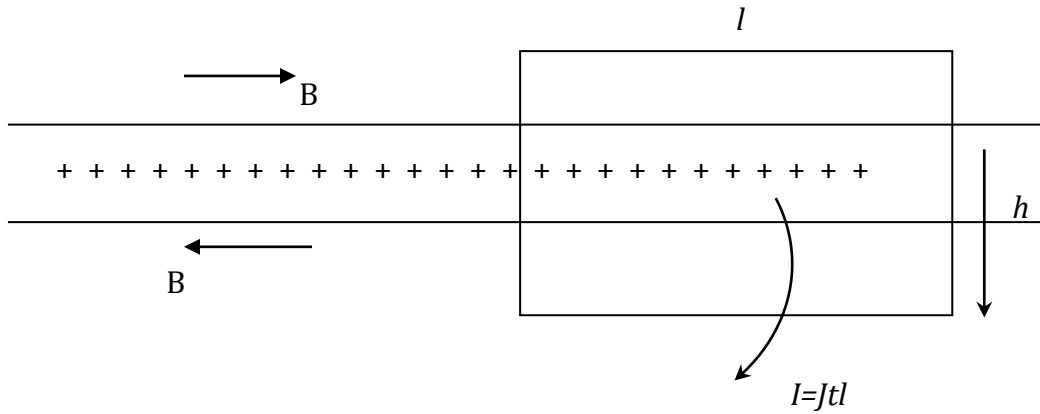

$$\begin{aligned} \oint_c \vec{B} \cdot d\vec{l} &= Bl + 0 + Bl + 0 \\ &= 2Bl \\ &= \mu_0 Jt \end{aligned}$$

so,

$$\begin{aligned} B &= \frac{\mu_0 Jt}{2} \quad \& \quad \vec{B} = \frac{\mu_0 Jt}{2} \hat{x} \quad y > 0 \\ &= -\frac{\mu_0 Jt}{2} \hat{x} \quad y < 0 \end{aligned}$$

That is, \vec{B} -field will jump by $\mu_0 Jt$ on crossing the current sheet from $y < 0$ to $y > 0$.

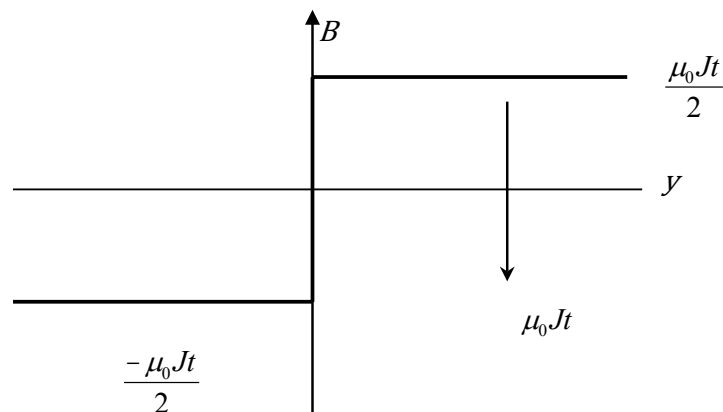

- 4) **Hollow Cylindrical Conductor** – Radius R , carries uniform current. We want \vec{B} at a distance r from its axis. Since there is a cylindrical symmetry we should use circles centered on the axis for our closed loop.

For $r < R$, use loop 1.

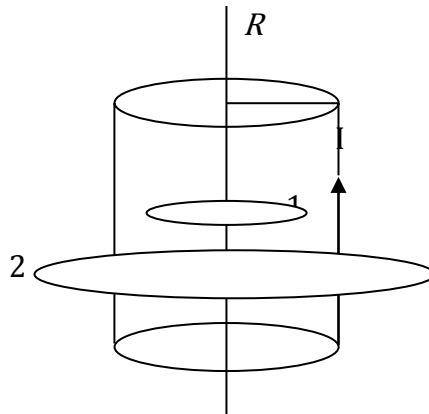

$B \cdot 2\pi r = 0$. No Current threads through loop 1.

for $r > R$, $B \cdot 2\pi r = \mu_0 I$, the entire current threads loop 2.

$$\text{so, } \vec{B} = \frac{\mu_0 I}{2\pi r} \hat{\phi}$$

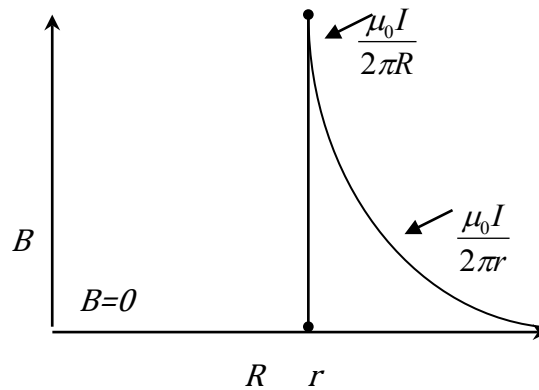

Note: if cylinder has wall thickness t : $I = J \cdot 2\pi R t$ and field at surface would be $\mu_0 J t$. Again field would jump by $\mu_0 J t$ on crossing a current sheet.

5) SOLID CYLINDRICAL CONDUCTOR – with uniform current

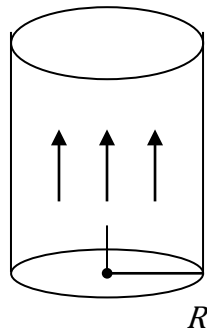

Define $J = \frac{I}{\pi R^2}$

Now for $r < R$ $I = J\pi r^2$

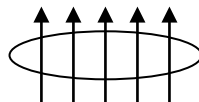

$B \cdot 2\pi r = \mu_0 J\pi r^2$

$B = \frac{\mu_0 J r}{2} \hat{\phi} \quad r < R$

For $r > R$, entire I contributes $B = \frac{\mu_0 I}{2\pi r} \hat{\phi}$

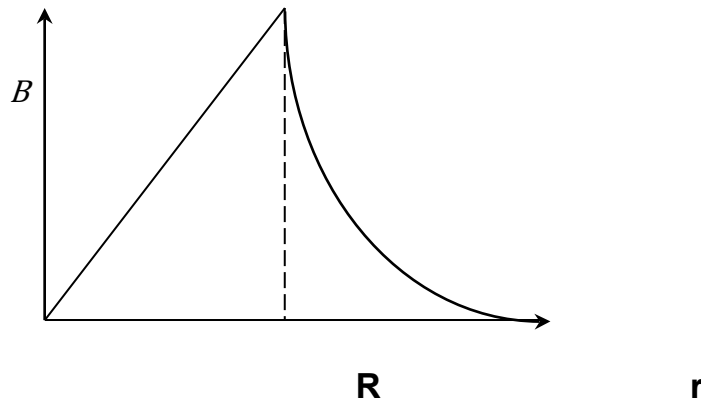

6) Solenoid: Tightly wound, small radius, length much larger than radius:

N turns, L long $n = \frac{N}{L} = \#$ of turns per meter.

Look at two neighboring turns

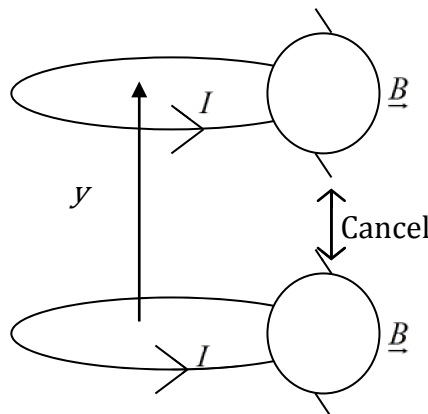

r-component cancels
 B_y inside survives.

Long-narrow solenoid. [\underline{B} field lines must come out of the top, loop around and enter at bottom with no breaks or bends allowed.]

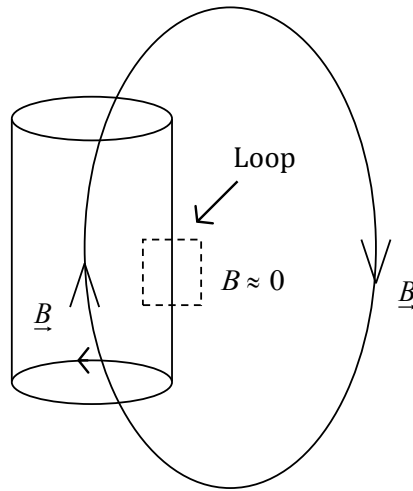

$B \approx 0$ just outside.
 \rightarrow

Take loop as shown $B l = \mu_0 n I l$
 $B = \mu_0 n I$

For case shown $\underline{B} = \mu_0 n I \hat{y}$

Excellent Economics and Business programmes at:



university of groningen



“The perfect start of a successful, international career.”

CLICK HERE
 to discover why both socially and academically the University of Groningen is one of the best places for a student to be

www.rug.nl/feb/education



18 Devices Using \underline{E} And \underline{B} Fields Cyclotron

This device works because the angular velocity of a charge moving in a \underline{B} field is **independent** of its speed.

$$\underline{F}_C = -\frac{MV^2}{r} \hat{r} \text{ is provided by}$$

$$\underline{F}_B = -qV B \hat{r}$$

$$\text{So } \omega = \frac{V}{r} = \frac{qB}{M}$$

The cyclotron combines a \underline{B} and an \underline{E} -field. In its simplest form it consists of two “DEES” in which there is constant \underline{B} -field. Say $\underline{B} = -B\hat{z}$.

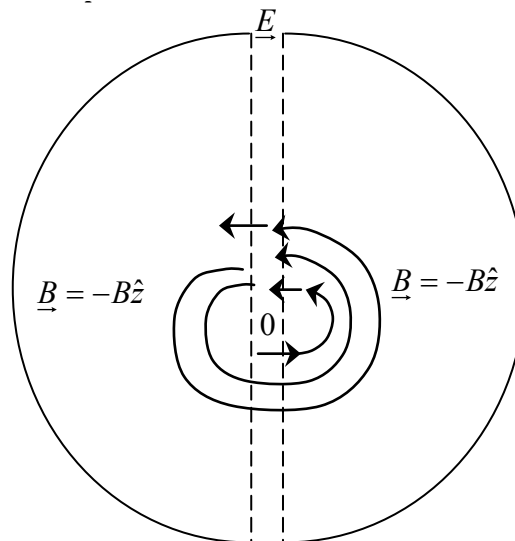

In the gap between them there is an \underline{E} -field which varies with time at the same angular frequency $\omega = \left(q \frac{B}{M} \right)$. Suppose at 0 you have a positive charge q which you accelerate with an \underline{E} -field so it enters the right DEE with a velocity $V\hat{x}$. The \underline{B} -field will make it go around a \odot with angular velocity ω . By the time it arrives in the gap \underline{E} will have reversed as the period of \underline{E} is the same as $\frac{2\pi}{\omega}$ so q will get accelerated again. In this way the charge goes round and round within the DEES and gets accelerated each time it crosses the gap. Indeed this device can accelerate charges to quite high speeds.

18.1 Velocity Selector

This again uses a combination of \underline{E} and \underline{B} and produces a beam of charges with a fixed speed controlled by the ratio $\frac{E}{B}$.

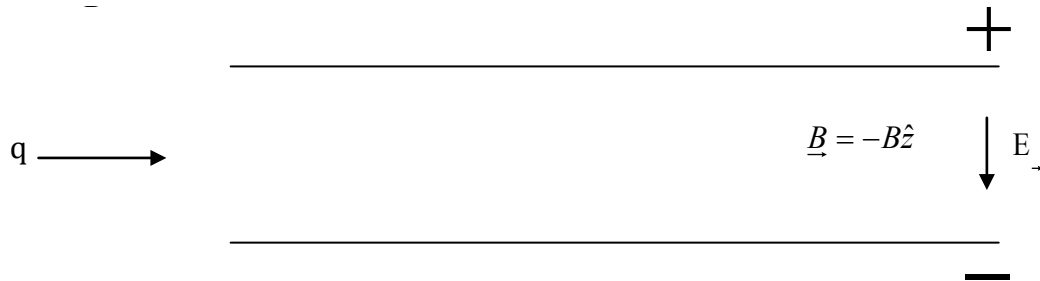

We begin with two parallel plates and establish an \underline{E} field between them

$$\underline{E} = -E\hat{y}$$

Introduce a beam of charges q with a distribution of velocities along the x-axis. Once they enter the \underline{E} field they will experience a force

$$\underline{F}_E = -qE\hat{y} \quad (1)$$

which will make them bend downward. Now, we introduce a $\underline{B} = -B\hat{z}$ between the plates. It will cause the particles to experience a force

$$\underline{F}_B = qvE\hat{y} \quad (2)$$

If we choose \underline{B} correctly, we can make

$$\underline{F}_B + \underline{F}_E = 0 \quad \rightarrow \quad (3)$$

Hence a charge whose speed satisfies Eq (3) will go between the plates straight through, that is if

$$v = \frac{E}{B}$$

the charge goes through. If V is larger $F_B > F_E$ charge will hit top plate, if $V < \frac{E}{B}$ charge will hit bottom plate.

18.2 Mass Spectrometer

This device is used to separate beams of isotopes, that is charged particles whose masses are different. Let us say we have a beam of charges q with two masses M_1 and M_2 . The device is as below.

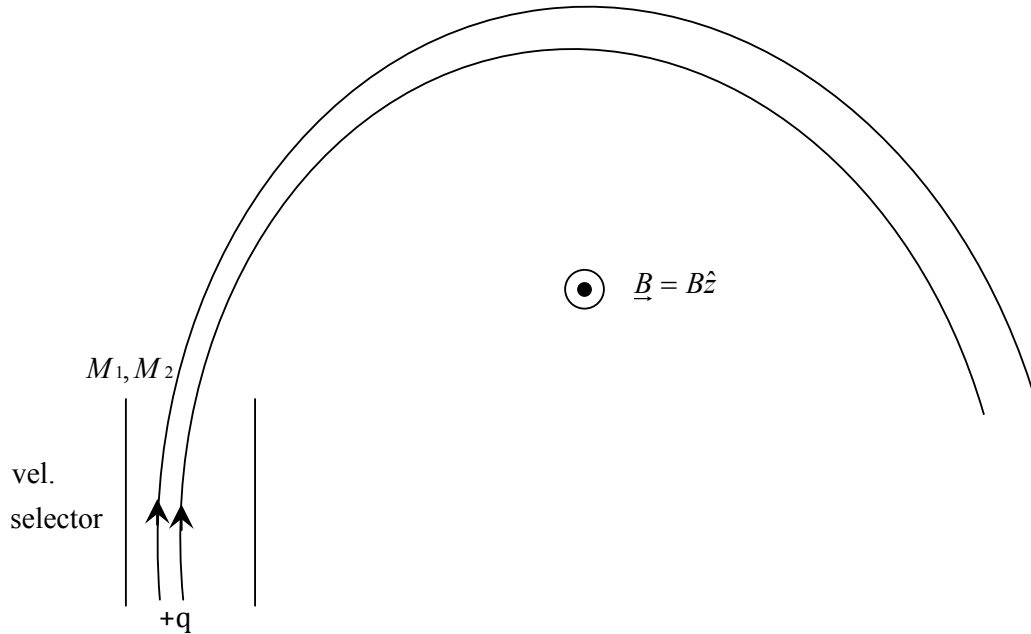

First, use a velocity selector so both masses have velocity $\underline{V} = V\hat{y}$. Next, apply $\underline{B} = B\hat{z}$ it will make the charges go on circles of radii

$$R_1 = \frac{M_1 V}{qB} \quad \text{and} \quad R_2 = \frac{M_2 V}{qB}$$

thereby separating them. It can also be used to separate two charged beams where particles have the same mass.

19 Magnetism

1. What is a **BAR Magnet**?

2. GAUSS' LAW FOR \vec{B} - FIELD

Any object which has a non-zero magnetic moment ($\vec{\mu}$) can be called a BAR MAGNET

because it will experience a torque $\vec{\tau} = \left[\begin{matrix} \vec{\mu} \times \vec{B} \\ \vec{} \times \vec{} \end{matrix} \right]$

When placed in a \vec{B} -field.

19.1 A "Bar" Magnet

To begin, let us recall that a current carrying loop of area A experiences a torque $\vec{\tau} = IA\hat{n} \times \vec{B}$.

Because it has a magnetic moment $\vec{\mu} = IA\hat{n}$. Incidentally, it also has potential energy $U_B = -\vec{\mu} \cdot \vec{B}$. So that \hat{n} wants to line up along \vec{B} .

Note, the similarity to an Electric Dipole of moment $\vec{p} = q\vec{l}$ placed in \vec{E} .

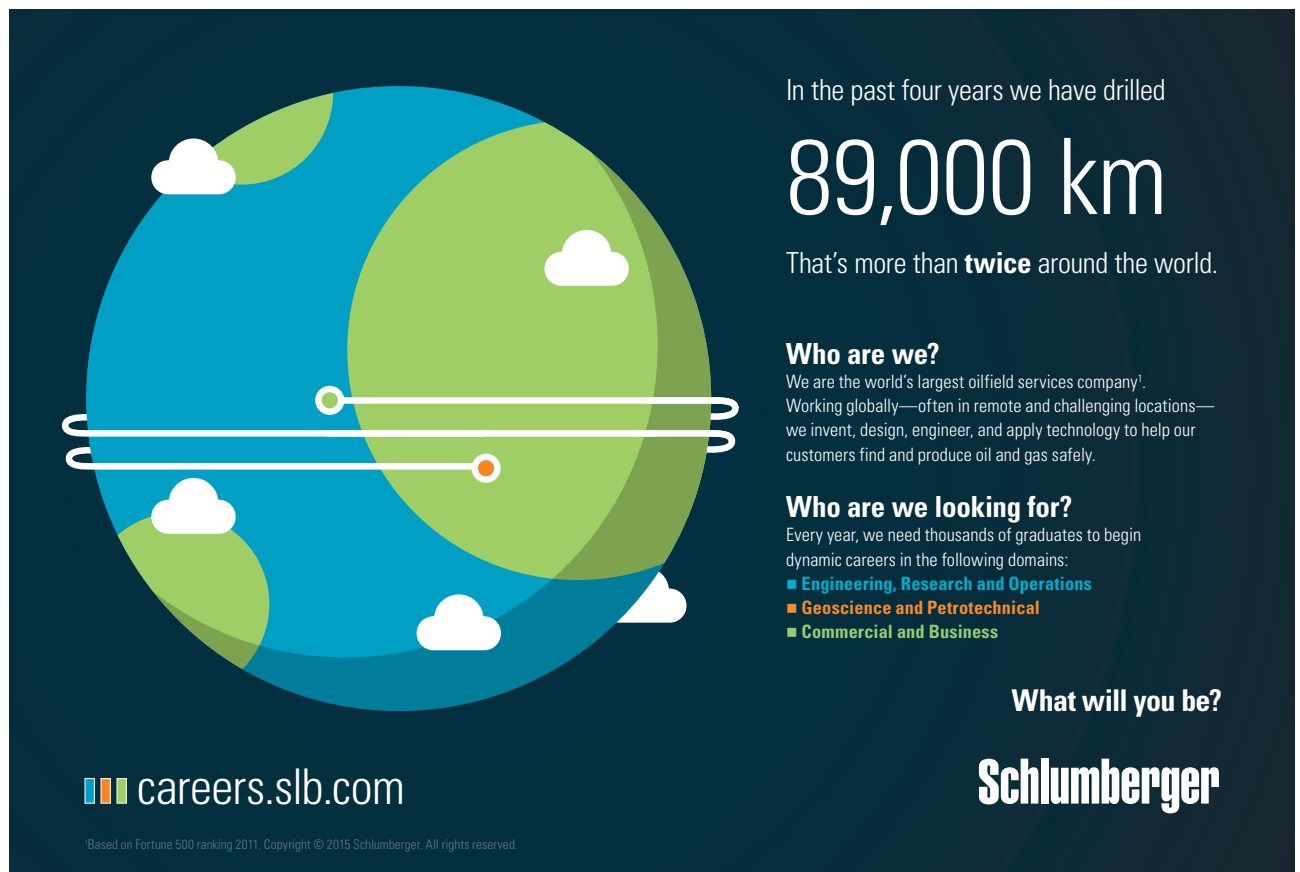

In the past four years we have drilled

89,000 km

That's more than **twice** around the world.

Who are we?
We are the world's largest oilfield services company¹. Working globally—often in remote and challenging locations—we invent, design, engineer, and apply technology to help our customers find and produce oil and gas safely.

Who are we looking for?
Every year, we need thousands of graduates to begin dynamic careers in the following domains:

- Engineering, Research and Operations
- Geoscience and Petrotechnical
- Commercial and Business

What will you be?

careers.slb.com

Schlumberger

¹Based on Fortune 500 ranking 2011. Copyright © 2015 Schlumberger. All rights reserved.



Torque is $\vec{\tau} = [\vec{p} \times \vec{E}]$

Potential Energy is $u_E = -\vec{p} \cdot \vec{E}$

Next, let us take a compass or a store bought bar magnet. If you suspend it in Earth's magnetic field, the compass or bar will line up along the Earth's \vec{B} -field. Again, this happens because of the torque on the compass (which is a bar magnet)

Earth is a giant bar magnet.

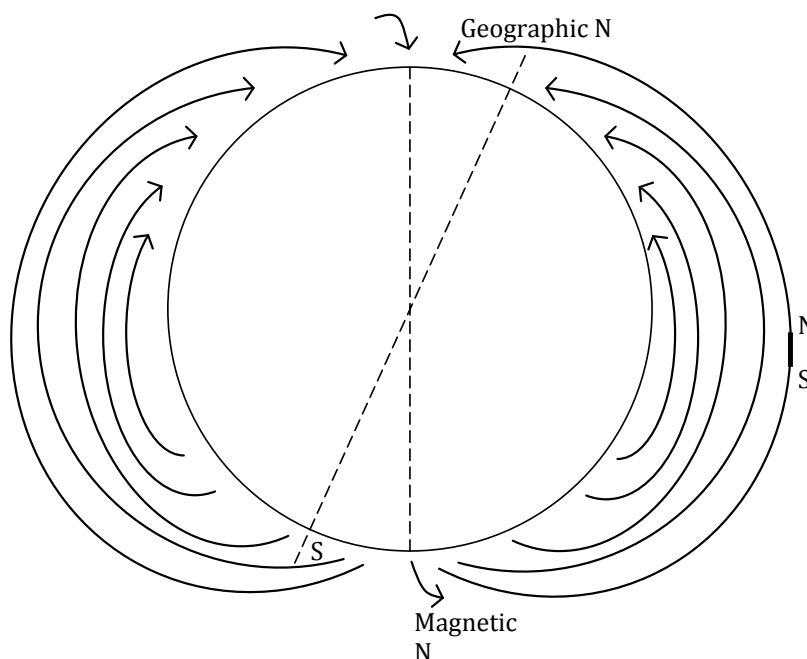

To understand this let us pretend that the B.M. can be imagined as consisting of magnetic “charges” $\pm m_c$ separated by l .

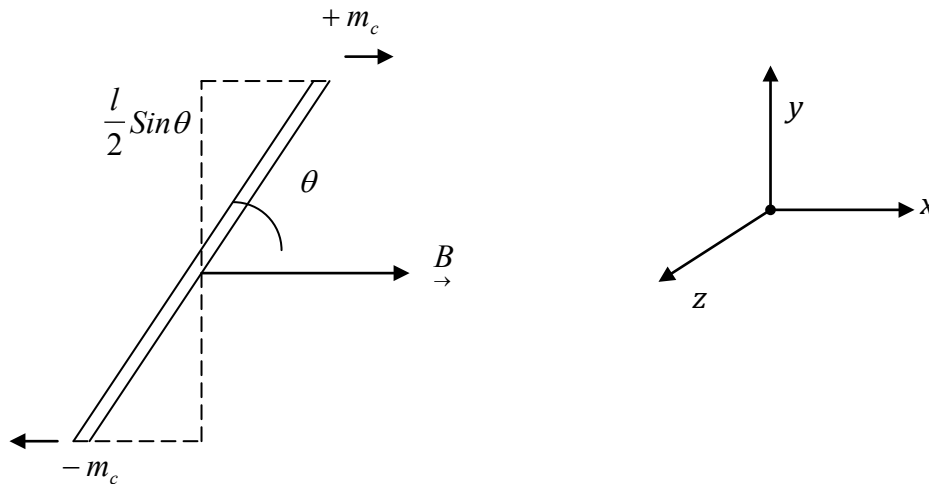

And we find that it experiences a Torque: $\vec{\tau} = -m_c l B \sin \Theta \hat{z}$ or $\vec{\tau} = \left[\vec{\mu} \times \vec{B} \right]$ with $\vec{\mu} = m_c l$

Question: Is the pretense justified?

Answer: A FIRM NO!

American online

LIGS University

is currently enrolling in the
Interactive Online **BBA, MBA, MSc,**
DBA and PhD programs:

- ▶ enroll **by September 30th, 2014** and
- ▶ **save up to 16%** on the tuition!
- ▶ pay in 10 installments / 2 years
- ▶ Interactive **Online** education
- ▶ visit www.ligsuniversity.com to find out more!

Note: LIGS University is not accredited by any nationally recognized accrediting agency listed by the US Secretary of Education. More info [here](#).





Why: If you break the B.M. in to two pieces you will **not** separate $+m_c$ and $-m_c$. You will get two bar magnets. Keep breaking and you get more and more bar magnets.

1 → 2 → 4 → 8 → → Single atom → ELECTRON

Ultimately, you will discover that a SINGLE Electron is a complete bar magnet because it has a magnetic dipole moment

$$\mu_e = 9.27 \times 10^{-24} \frac{N \cdot m}{T}$$

Which is called a Bohr magneton (μ_B). Thanks to quantum mechanics we now know that in addition to charge e ($= 1.6 \times 10^{-19} C$) and mass m_e ($= 9 \times 10^{-31} kg$) an electron has an intrinsic property called spin s ($= 1/2$) which endows it with a magnetic moment

$$\mu_e = \mu_B = \frac{2e\hbar}{2m_e} s$$

where $\hbar \cong 10^{-34} J \cdot s$ so if an electron is placed in a 1 Tesla field and its moment is perpendicular to \vec{B} it will experience a torque of $9.27 \times 10^{-24} N \cdot m$.

Indeed, even nuclei have a magnetic moment but since mass of proton is about 2000 m_e , nuclear moments are much smaller.

So now that we have the elementary “building blocks” let us start “constructing” a bar magnet beginning with electrons. The next constituent is the atom. Here, to get a non-zero μ_A we need unpaired Electrons. That is, if the electrons are arranged in pairs so that they look like

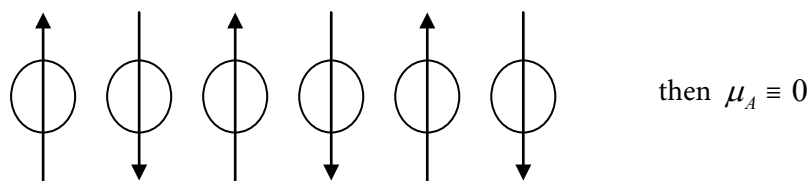

and that atom is no good to make a B.M. Iron, on the other hand, is a “good” atom. Fe^{3+} has five unpaired electrons.

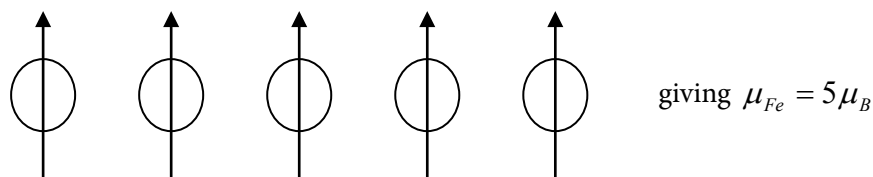

at the simplest level.

Next, put these atoms into a solid. At high temperatures, the thermal energies make these atomic moments wobble rapidly so that the time average

$$\langle \mu_A \rangle \equiv 0$$

and all we get is a **paramagnet**. There is **no** net moment, so no bar magnet.

However, [recall the dielectric in an \vec{E} -field] if we put the material in an applied magnetic \vec{B} it will cause all the moments to line up and the solid will acquire a magnetic moment μ_{Sol} : We can define the Magnetization

$$M = \frac{\mu_{Sol}}{Volume}$$

It has units of $\frac{A \cdot m^2}{m^3}$ or $\frac{A}{m}$ which are the same as units of $\frac{B}{\mu_0}$

Simple Experiment: Take a Solenoid. Pass a current I . We will get $B_0 = \mu_0 n I = \mu_0 H$

Next, fill the solenoid with a paramagnet. We will find that the \vec{B} -field enhances to

$$\begin{aligned} B &= \mu_0 n I + \mu_0 M \\ &= \mu_0 (H + M) = \mu_0 H (1 + \chi_m) \end{aligned}$$

.....Alcatel-Lucent 

www.alcatel-lucent.com/careers



What if you could build your future and create the future?

One generation's transformation is the next's status quo. In the near future, people may soon think it's strange that devices ever had to be "plugged in." To obtain that status, there needs to be "The Shift".



Click on the ad to read more

Which defines the magnetic susceptibility $\chi_m = \frac{M}{H}$

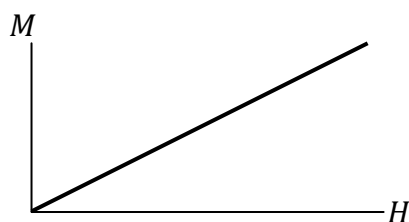

In the paramagnet, χ_m is a constant, independent of H . M is linear in H . However, χ_m is a function of temperature.

On reducing T , χ_m increases according to $\chi_m = \frac{c}{T}$ and this will hold if the atomic moments do not “talk” to one another and we will never get a bar magnet.

Fortunately, again thanks to quantum mechanics, in some materials (Fe and Ni are most familiar) the atomic moments interact with one another and produce an internal field proportional to M . In such systems one can write $M = \chi_m[H + \lambda M]$ where λ is a constant. Again $M = \frac{c}{T}(H + \lambda M)$ and we should find $\chi'_m = \frac{M}{H} = \frac{c}{T - \lambda c}$ and we note that if T is reduced until $T = \lambda c$, χ'_m will blow up. That is, the material will have a spontaneous magnetic moment M . We have succeeded in making a **FERROMAGNET**. For example, *Ni* becomes a ferromagnet at $T \leq 630K$.

At lower temperatures the system can be imagined as consisting of “domains” each of which contains billions of atoms with their μ_A 's aligned. These domains

Ferromagnet

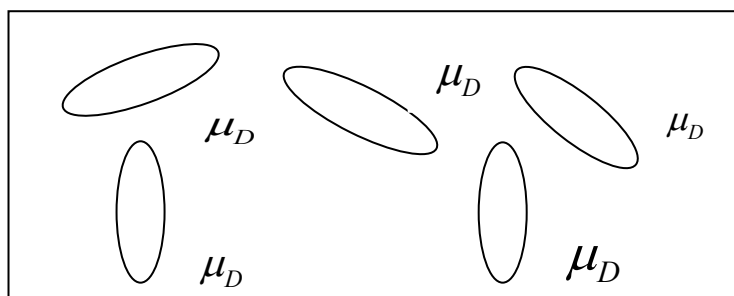

(Only few domains are drawn) have giant magnetic moments μ_D and the response to an applied field is greatly enhanced.

The last step in constructing a B.M. is to recognize that we need a material in which there is a preferred direction. That is, the μ_D 's prefer to lie along some axis. Let us assume that for our bar this is along \hat{x} . If we apply a $\vec{B} \parallel \hat{x}$ all the μ_D 's will align along \hat{x} and we get

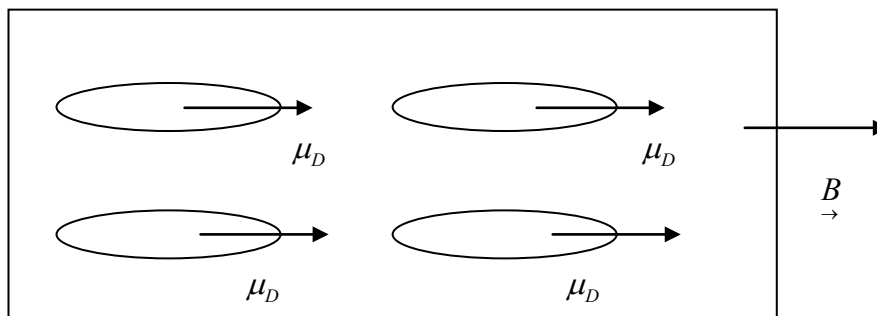

and every domain has its μ_D along direction where it prefers to stay. So next if we remove \vec{B} , the μ_D 's will stay put, the Bar has a “permanent” magnetic moment. Indeed, we have “constructed” a **BAR MAGNET**

Which has a \vec{B} field looking like

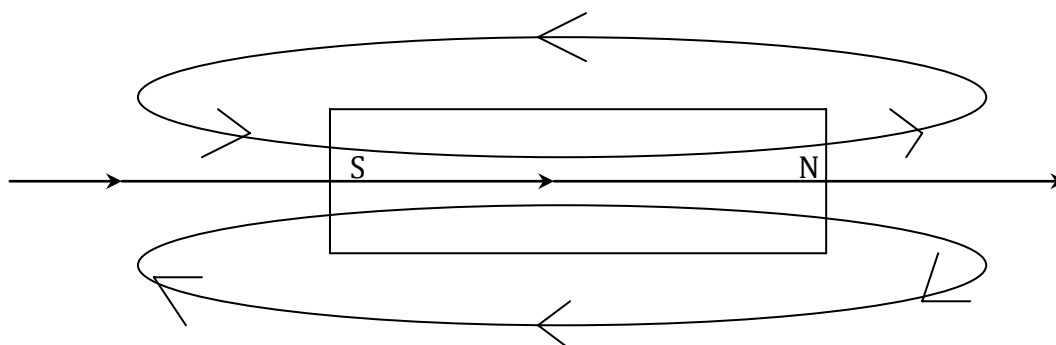

19.1 Gauss’s Law For \vec{B}

FACT: A single electron is a complete magnet with a dipole moment μ_B .

CONSEQUENCE: Elementary source of \vec{B} is a **DIPOLE** with effectively “zero” size. “Sources” and “sinks” are coincident. When we use lines to map \vec{B} -fields the lines must close **on Themselves**. There is no “beginning” and no “end” to a \vec{B} -field line.

PROFOUND IMPLICATION: Total flux of \vec{B} through any **closed** surface must be always equal to zero:

$$\Sigma_c = \vec{B} \cdot \underline{\Delta A} \equiv 0$$

Every line that comes into enclosed volume must go out as \vec{B} -field lines **do not** stop or start anywhere.

NOTE: The law tells you that the total **flux** of \vec{B} through a closed surface is zero. It says **nothing** about \vec{B} .

Also, surface must be closed!

Example

Suppose that the “surface” is formed by the six faces of a cube. We are told that through five faces there is a flux of $(0.5)T - m^2$ per face. Then this law says that through the sixth face there must be a flux of $-(2.5)T - m^2$ so that

$$[5 \times 0.5 - 2.5] \equiv 0!$$

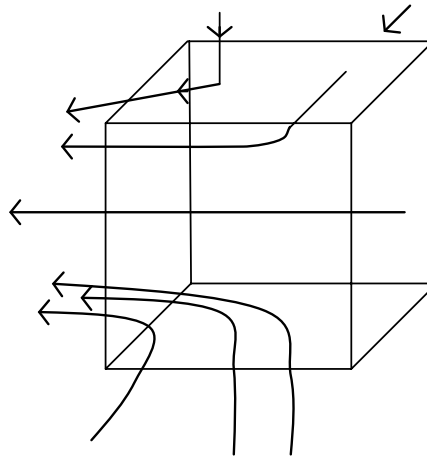

20 Non-Coulomb \vec{E} Field (Induction)

We begin by considering a uniform \vec{B} -field represented by a set of parallel lines. Next, imagine an area ΔA whose normal

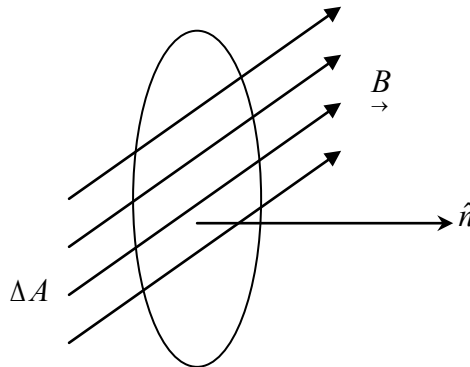

Join the best at
the Maastricht University
School of Business and
Economics!

Top master's programmes

- 33rd place Financial Times worldwide ranking: MSc International Business
- 1st place: MSc International Business
- 1st place: MSc Financial Economics
- 2nd place: MSc Management of Learning
- 2nd place: MSc Economics
- 2nd place: MSc Econometrics and Operations Research
- 2nd place: MSc Global Supply Chain Management and Change

Sources: Keuzegids Master ranking 2013; Elsevier 'Beste Studies' ranking 2012; Financial Times Global Masters in Management ranking 2012

Maastricht University is the best specialist university in the Netherlands (Elsevier)

Visit us and find out why we are the best!
Master's Open Day: 22 February 2014

www.mastersopenday.nl



Click on the ad to read more

is along \hat{n} . Then, as in the case of \underline{E} , we define flux of \underline{B} through ΔA to be

$$\Delta\Phi_B = \underline{B} \cdot \underline{\Delta A} = B\Delta A \cos(\underline{B}, \hat{n})$$

As before, flux is maximum when $\underline{B} \parallel \hat{n}$ (\perp to area) and zero if $\underline{B} \perp \hat{n}$ (\underline{B} lines lie in plane of ΔA).

Faraday's discovery was that if the flux of \underline{B} , $\Delta\Phi_B$, changes as a function of time, that is

$$\frac{\Delta\Phi_B}{\Delta t} \neq 0$$

There will be an \underline{E} -field induced in every loop surrounding the region where Φ_B is changing. For example, in the picture if the \underline{B} field varies with time an \underline{E} -field will appear at every point of the dashed loop.

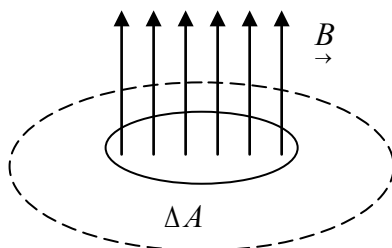

This new \underline{E} -field we call a Non-Coulomb \underline{E} -field. The following points are noteworthy:

1. Flux of \underline{B} can vary with time in 3 ways
 - 1) Magnitude of \underline{B} is a function of time
 - 2) The area ΔA where \underline{B} is non-zero varies with time
 - 3) Angle between \underline{B} and \hat{n} varies with time
2. If there is an \underline{E} -field at every point on a closed loop, there must be an $\mathcal{E}mf$ in the loop given by

$$\mathcal{E} = \sum_C \underline{E}_{NC} \cdot \underline{\Delta l}$$

since $\mathcal{E}mf$ is the work done on a unit charge by an \underline{E} -field.

3. Since the change of potential on a closed loop is **NOT** zero, \underline{E}_{NC} is NOT A CONSERVATIVE FIELD.

4. The \underline{E}_{NC} field lines close on themselves, there is no beginning and no end. This is totally different from the Coulomb \underline{E} which “started” at positive charges and “ended” at negative charges.

5. For \underline{E}_{NC} Gauss’ Law will always give

$$\Sigma_C \underline{E}_{NC} \bullet \underline{\Delta A} \equiv 0$$

Total flux of \underline{E}_{NC} through any closed surface is always ZERO.

6. However, a charge q placed in \underline{E}_{NC} experiences a force

$$\underline{F}_E = q\underline{E}_{NC}$$

exactly as for a Coulomb \underline{E} -field.

Although Faraday discovered the induced *emf*, it was left to Lenz to assert that the direction of \underline{E}_{NC} must be such as to **oppose** the change in the flux of \underline{B} that causes the \underline{E}_{NC} , namely

$$\varepsilon = \Sigma_C \underline{E}_{NC} \bullet \underline{\Delta l} = \frac{-\Delta\Phi_B}{\Delta t}$$



> **Apply now**

REDEFINE YOUR FUTURE
**AXA GLOBAL GRADUATE
PROGRAM 2015**

redefining / standards 

agence.cdg. © Photonistop

Eventually, Helmholtz showed that the minus sign on the right side is crucial because it arises from Conservation of Energy. Omitting the minus sign would lead to a “run away” situation causing an energy catastrophe.

To Summarize the above we say:

The circulation of non-coulomb \underline{E} around a closed loop is determined by the time rate of change of the flux of \underline{B} through the area inside the loop. The sense of \underline{E}_{NC} is such as to oppose the change in the flux of \underline{B}

20.1 Applications

1. Consider the picture.

There is a uniform $\underline{B} = B\hat{y}$ everywhere. The radius of the loop is r . Let \underline{B} increase with time $\frac{\Delta B}{\Delta t} > 0$. It will set up E_{NC} in the loop.

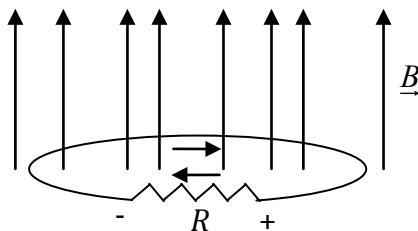

$$\varepsilon = E_{NC} 2\pi r = -\pi r^2 \frac{\Delta B}{\Delta t}$$

and the direction of E_{NC} in the loop must be clockwise. Current in R will flow to left from right.

$$I = \frac{\pi r^2}{R} \frac{\Delta B}{\Delta t}$$

[Notice: the loop acts like a “battery” and current flows from $-$ to $+$ inside the battery and from $+$ to $-$ in the load R .]

2. The coil of resistance R is in the xz -plane while $\underline{B} = B\hat{y}$

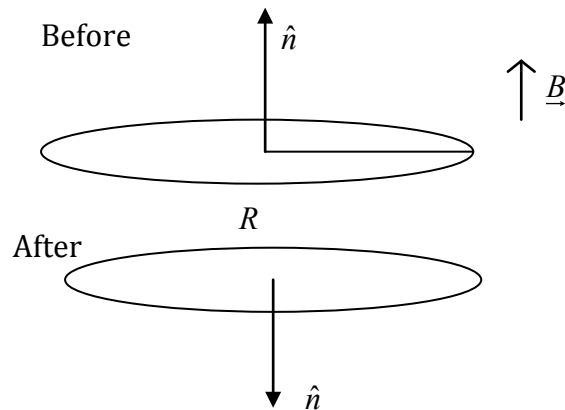

Flip the coil by 180°

Flux change will be

$$\begin{aligned}\Delta\Phi_B &= -B\pi r^2 - B\pi r^2 \\ &= -2B\pi r^2\end{aligned}$$

Supposing this flip takes t sec. Then

$$\frac{\Delta\Phi_B}{\Delta t} = \frac{-2B\pi r^2}{tR}$$

Since flux is reducing, \mathcal{E} in coil must be counter clockwise.

$$\text{current in coil } I = \frac{2B\pi r^2}{tR}$$

$$\text{current is flow of charge } I = \frac{\Delta Q}{t}$$

$$\text{so } \Delta Q = \frac{2B\pi r^2}{R}$$

that is, when coil is flipped ΔQ coulombs of charge circulate counter clockwise in it. If you keep flipping it, current will continue to flow, alternately cw and ccw.

3. Calculate the \vec{E}_{NC} for a solenoid at a distance r from its axis when the flux of \vec{B} is varied by time variation of the current in the solenoid. That is, $\frac{\Delta i}{\Delta t} \neq 0 \Rightarrow \frac{\Delta B}{\Delta t} \neq 0 \Rightarrow \frac{\Delta \Phi_B}{\Delta t} \neq 0$. Consider a solenoid wound on a tube of radius a . If there are n turns per meter and the current flow is as shown, there is a uniform \vec{B} inside it

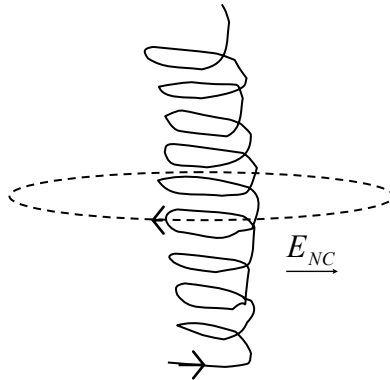

$$\vec{B} = \mu_0 n i \hat{y}$$

and hence

$$\frac{\Delta \vec{B}}{\Delta t} = \mu_0 n \frac{\Delta i}{\Delta t} \hat{y}$$

The problem has cylindrical symmetry about axis of solenoid, \vec{E}_{NC} at r must be a function of r only and must be azimuthal. Let i increase with time. Then flux of \vec{B} along $+\hat{y}$ is increasing with time. Take a circular loop. As shown direction of \vec{E}_{NC} must be clockwise (as viewed from above) to oppose increase of Φ_B .

Next,

$$\text{If } r < a \quad E_{NC} 2\pi r = -\mu_0 n \pi r^2 \frac{\Delta i}{\Delta t} \quad [\text{LOOP INSIDE SOLENOID}]$$

$$\text{If } r > a \quad E_{NC} 2\pi r = -\mu_0 n \pi a^2 \frac{\Delta i}{\Delta t} \quad [\text{LOOP OUTSIDE SOLENOID}]$$

Magnitude

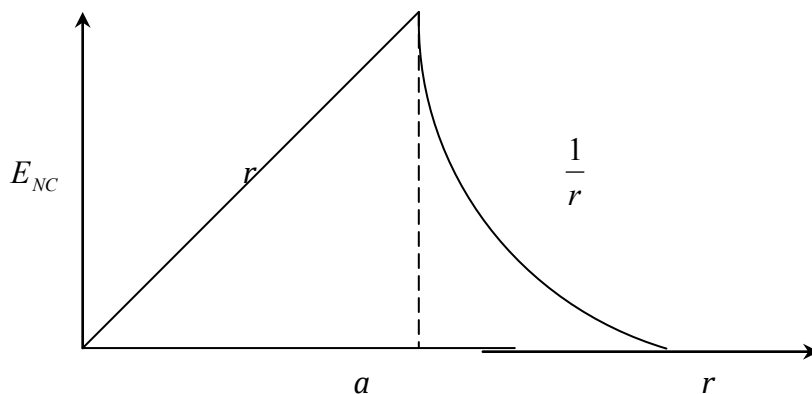

$$E_{NC} = \frac{-\mu_0 n r \Delta i}{2 \Delta t} \quad r < a$$

$$E_{NC} = -\mu_0 n \frac{a^2 \Delta i}{2r \Delta t} \quad r > a$$

It is useful to ask what is the *emf* in these two loops $\varepsilon = \sum_C \underline{E}_{NC} \bullet \underline{\Delta l}$

$$r < a \quad \varepsilon = E_{NC} \cdot 2\pi r = \frac{-\mu_0 n \pi r^2 \Delta i}{\Delta t}$$

$$r > a \quad \varepsilon = -\mu_0 n \pi a^2 \frac{\Delta i}{\Delta t}$$

BI NORWEGIAN BUSINESS SCHOOL

- Business
- Strategic Marketing Management
- International Business
- Leadership & Organisational Psychology
- Shipping Management
- Financial Economics

Empowering People. Improving Business.

BI Norwegian Business School is one of Europe's largest business schools welcoming more than 20,000 students. Our programmes provide a stimulating and multi-cultural learning environment with an international outlook ultimately providing students with professional skills to meet the increasing needs of businesses.

BI offers four different two-year, full-time Master of Science (MSc) programmes that are taught entirely in English and have been designed to provide professional skills to meet the increasing need of businesses. The MSc programmes provide a stimulating and multi-cultural learning environment to give you the best platform to launch into your career.

- MSc in Business
- MSc in Financial Economics
- MSc in Strategic Marketing Management
- MSc in Leadership and Organisational Psychology

www.bi.edu/master



Inside ε increases as r^2 Outside it is constant for all r !

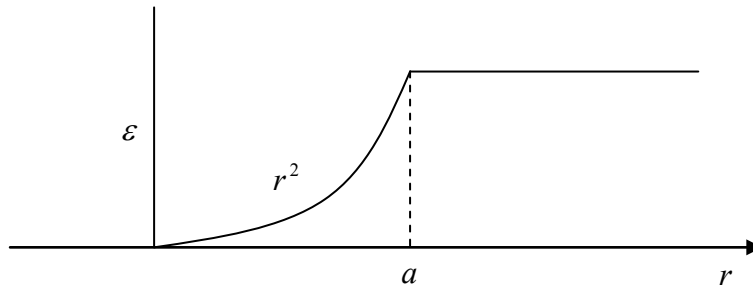

20.2 Non-Coulomb \underline{E} [Motional εmf]

It is far from easy for us to understand the origin of the E_{NC} and the consequent induced εmf . However, there is one analogous situation where we can use our present knowledge to see how motion of a conductor in a \underline{B} -field causes an εmf to appear within the conductor.

Consider a copper bar of length l moving with velocity $v\hat{x}$ in the presence of a uniform \underline{B} field $\underline{B} = -B\hat{z}$

An electron inside the conductor feels the force

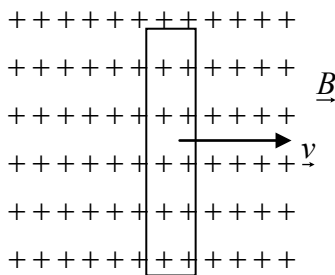

$$\underline{F}_B = q[\underline{v} \times \underline{B}]$$

which is in the negative y-direction

$$\underline{F}_B = -evB\hat{y}$$

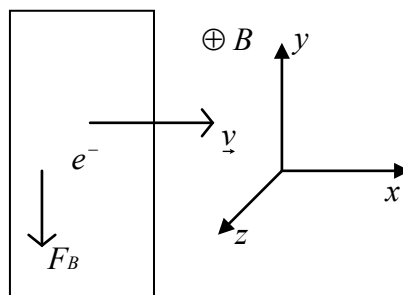

That will cause electrons to drift toward the bottom leaving an excess positive charge at the top which will cause an \underline{E} field

$$\underline{E} = -E\hat{y}$$

and a force

$$\underline{F}_E = +eE\hat{y}$$

on the electron.

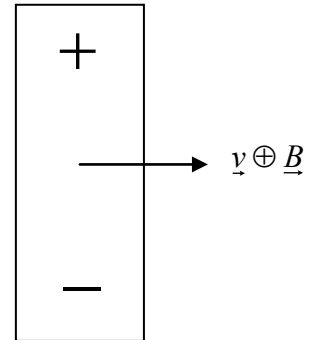

Further segregation of charge will stop when

$$\underline{F}_E + \underline{F}_B = 0$$

that is

$$e\nu B = eE$$

$$E = \nu B$$

and this will cause an $\mathcal{E}mf$

$$\mathcal{E} = VBl$$

to appear in the bar.

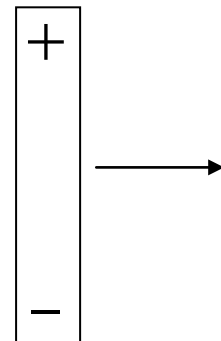
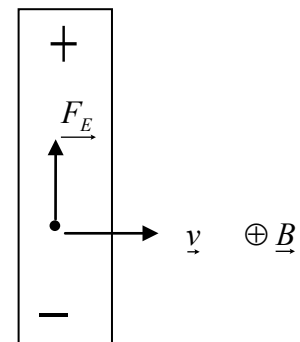

Question \underline{B} field does no work on the electron, so where does the energy originate to set up E . Initially, the charges move, there is ν_D along bar and the Force \underline{F} does $\underline{F} \cdot \underline{\nu}_e$ per second.

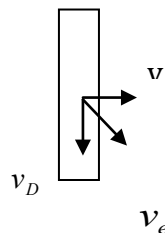

The $\mathcal{E}mf$ is exactly the answer you get if you consider the situation below and use

$$\mathcal{E} = \frac{-\Delta\Phi_B}{\Delta t}$$

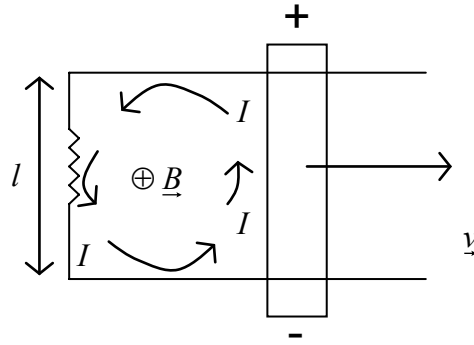

$$\begin{aligned}\frac{\Delta\Phi_B}{\Delta t} &= B \frac{\Delta A}{\Delta t} \\ &= Bvl\end{aligned}$$

and Lenz's Law tells us that the induced $\mathcal{E}mf$ must oppose the increase in flux of \underline{B} into the page requiring negative at the bottom and plus at the top leading to a counterclockwise current.

Need help with your dissertation?

Get in-depth feedback & advice from experts in your topic area. Find out what you can do to improve the quality of your dissertation!

Get Help Now



Go to www.helpmyassignment.co.uk for more info

 **Helpmyassignment**

21 Devices For Non-Coulomb \underline{E}

Inductor is a device which stores a \underline{B} -field. Consider the following: In such a device

If i then B

$$\text{If } \frac{\Delta i}{\Delta t} \text{ then } \frac{\Delta B}{\Delta t} \text{ then } \frac{\Delta \Phi_B}{\Delta t} \text{ then } -\varepsilon$$

We define the

$$\text{Inductance } L = \frac{-\varepsilon}{\frac{\Delta i}{\Delta t}} \quad [\text{effect/cause}]$$

Unit of L is $\frac{\text{Volt-sec}}{\text{Amp}}$ and is called Henry. And the symbol is

21.1 Self Inductance $\frac{\Delta i}{\Delta t}$ and ε in the same coil

A tightly wound solenoid of area A and N turns spread over a length l . If the current is i

$$\underline{B} = \mu_0 n i \hat{y} \quad \left[n = \frac{N}{l} \right]$$

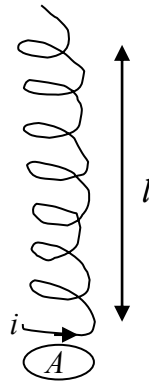

Parallel to the axis of the solenoid and essentially constant inside it. With i varying

$$\frac{\Delta B}{\Delta t} = \mu_0 n \frac{\Delta i}{\Delta t}$$

and

$$\frac{\Delta \Phi_B}{\Delta t} = \mu_0 n A \frac{\Delta i}{\Delta t}$$

In one ring of the solenoid this will cause *emf*

$$\varepsilon_1 = -\mu_0 n A \frac{\Delta i}{\Delta t}$$

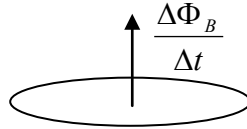

since there are N rings *emf*, for the entire solenoid

$$\varepsilon_N = -\mu_0 n N A \frac{\Delta i}{\Delta t}$$

So self inductance

$$L = \frac{-\varepsilon_N}{\frac{\Delta i}{\Delta t}} = \mu_0 n N A = \mu_0 n^2 \mathcal{H} = \mu_0 n^2 V$$

$V = Al$ being the volume of the solenoid

21.2 Mutual Inductance

$\frac{\Delta i}{\Delta t}$ in one coil, induces an *emf* in a second coil because the time varying flux of \underline{B} also occurs inside the second coil. So now we have two coils each of length l one has n_1 turns per meter and the other has n_2 turns per meter and the second coil is wound on top of the first so both have the same cross-section A .

Once again due to current change in coil 1

$$\frac{\Delta \Phi_B}{\Delta t} = \mu_0 n_1 A \frac{\Delta i}{\Delta t}$$

Induced *emf* in one ring of coil 2

$$\varepsilon_{1n_1} = -\mu_0 n_1 A \frac{\Delta i}{\Delta t}$$

Induced *emf* in entire 2nd coil

$$\varepsilon_{N_2 n_1} = -\mu_0 n_1 n_2 \mathcal{H} \frac{\Delta i}{\Delta t}$$

Mutual Inductance

$$M_1 = \frac{-\varepsilon_{N_2 n_1}}{\frac{\Delta i}{\Delta t}} = \mu_0 n_1 n_2 V = \sqrt{L_1 L_2}$$

where L_1 and L_2 are the self-inductances of the two coils.

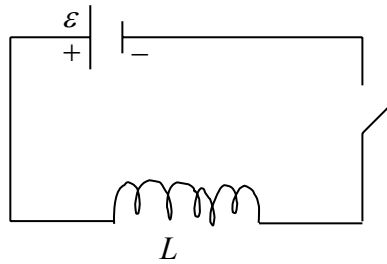

Next, we calculate the work done in establishing current in an inductor – Energy stored in a \underline{B} field: When you close the switch the battery will try to establish a current in the inductor and of course the inductor will object by setting up an *emf*

$$\varepsilon_L = -L \frac{\Delta i}{\Delta t}$$

when the next Δq of charge makes its way through the inductor the work done will be

$$\Delta W = \Delta q L \frac{\Delta i}{\Delta t} = Li \Delta i$$

since $\frac{\Delta q}{\Delta t} = i$

Brain power

By 2020, wind could provide one-tenth of our planet's electricity needs. Already today, SKF's innovative know-how is crucial to running a large proportion of the world's wind turbines.

Up to 25 % of the generating costs relate to maintenance. These can be reduced dramatically thanks to our systems for on-line condition monitoring and automatic lubrication. We help make it more economical to create cleaner, cheaper energy out of thin air.

By sharing our experience, expertise, and creativity, industries can boost performance beyond expectations. Therefore we need the best employees who can meet this challenge!

The Power of Knowledge Engineering

Plug into The Power of Knowledge Engineering.
Visit us at www.skf.com/knowledge

SKF

To calculate work needed to increase current from 0 to I , plot Li as a function of i and we note that $Li\Delta i$ is the area of the rectangle. The area of the triangle tells us how much work is needed to establish I in L .

$$W_B = \frac{1}{2} L I^2$$

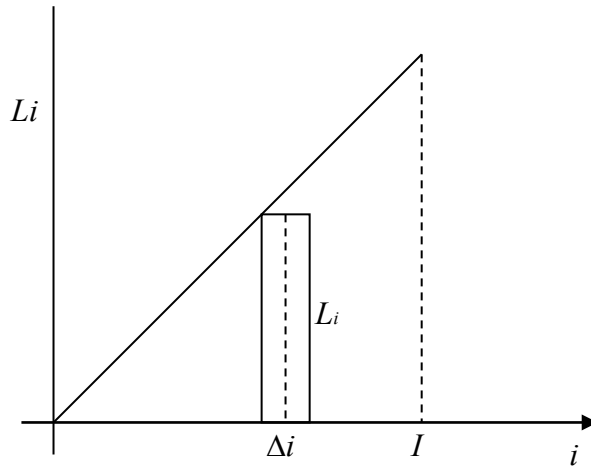

Where did all the energy go? Notice that once the current is established the inductor is not empty, there is a \underline{B} -field inside it and W_B is stored in this \underline{B} -field. If you apply it to a solenoid

$$L = \mu_0 n^2 V$$

$$B = \mu_0 n I$$

$$W_B = \frac{1}{2} \mu_0 n^2 I^2 V$$

So energy density of \underline{B} -field

$$\eta_B = \frac{B^2}{2\mu_0}$$

Is the energy stored in 1 m^3 of \underline{B} -field.

21.3 Devices L-R Circuits

We have three devices:

A **Battery**: Creates a Coulomb \underline{E} using chemical energy

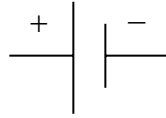

and output is the *emf* ε .

A **Resistor** (R): arises because it costs energy to transport charge through a conductor so that if you establish a current i , a voltage drop V appears across R such that

$$V = iR$$

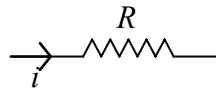

An **Inductor** (L): opposes any time variation of current through it by setting up an *emf*

$$\varepsilon = -L \frac{\Delta i}{\Delta t}$$

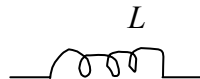

Now we want to study what happens when we connect our 3-devices, Battery, R and L in the circuit below.

At $t=0$, put the switch as shown ($1 \rightarrow 2$). The battery immediately wants to set up a current. However, L promptly **objects*** by setting up a “back” *emf*, which will oppose ε , $\varepsilon_B = -L \left(\frac{\Delta i}{\Delta t} \right)_0$

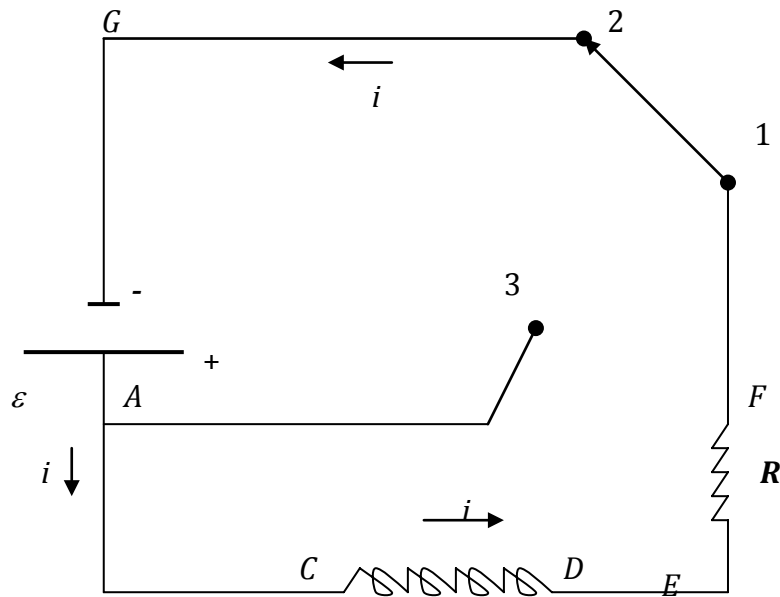

* The “minus” sign in the equation ensures that an inductor always opposes any change in current through it.

Thus it will take time for the current to grow.

Step 1 at $t=0$, $i=0$, No potential drop across R . As a function of position on the circuit the potential values are

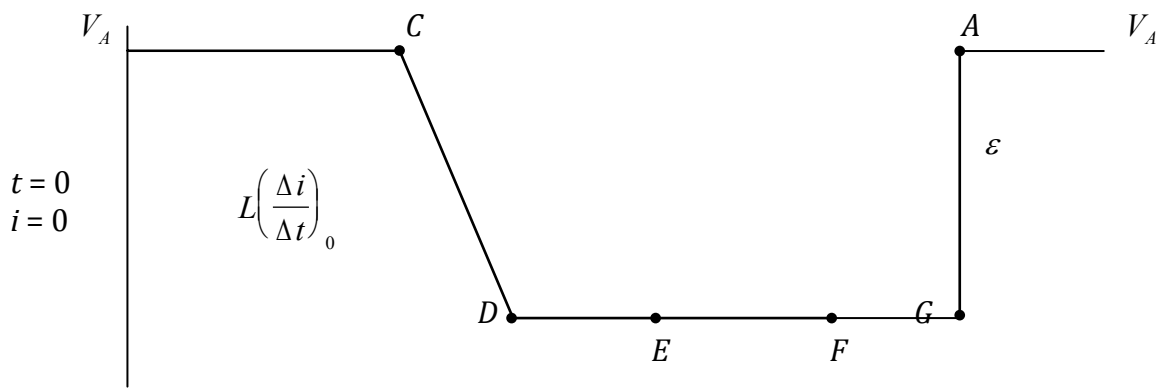

$$\varepsilon - L \left(\frac{\Delta i}{\Delta t} \right)_0 = 0$$

Step 2 A little time later i has grown some so now $v_R = iR$ and the potentials become

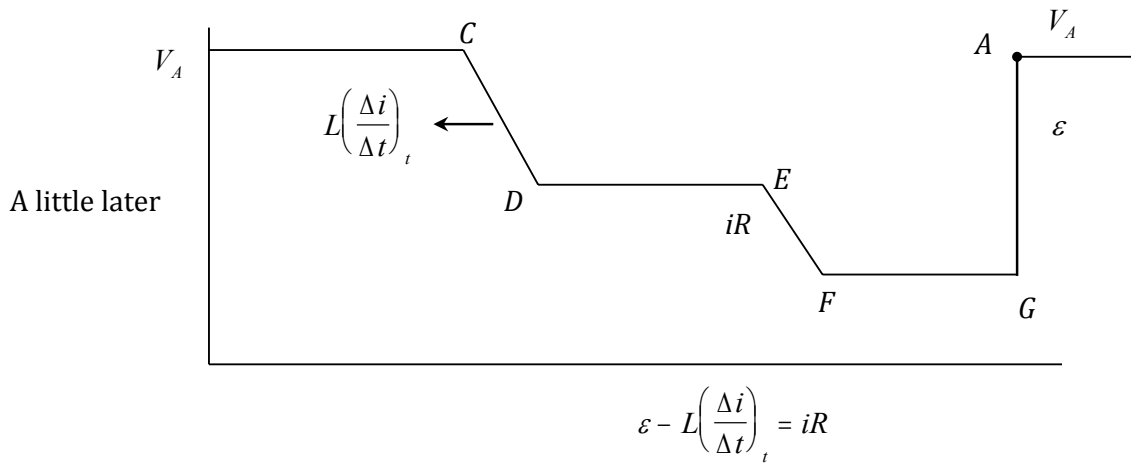

Clearly, $\left(\frac{\Delta i}{\Delta t}\right)_t < \left(\frac{\Delta i}{\Delta t}\right)_0$ Rate of growth has slowed down.

Step 3 A long time later i has grown to its full value, i stops changing with time, $\frac{\Delta i}{\Delta t} \rightarrow 0$ so no more back *emf* from L . Potential variation looks like.

What do you want to do?

No matter what you want out of your future career, an employer with a broad range of operations in a load of countries will always be the ticket. Working within the Volvo Group means more than 100,000 friends and colleagues in more than 185 countries all over the world. We offer graduates great career opportunities – check out the Career section at our web site www.volvogroup.com. We look forward to getting to know you!

VOLVO
 AB Volvo (publ)
www.volvogroup.com

VOLVO TRUCKS | RENAULT TRUCKS | MACK TRUCKS | VOLVO BUSES | VOLVO CONSTRUCTION EQUIPMENT | VOLVO PENTA | VOLVO AERO | VOLVO IT
 VOLVO FINANCIAL SERVICES | VOLVO 3P | VOLVO POWERTRAIN | VOLVO PARTS | VOLVO TECHNOLOGY | VOLVO LOGISTICS | BUSINESS AREA ASIA



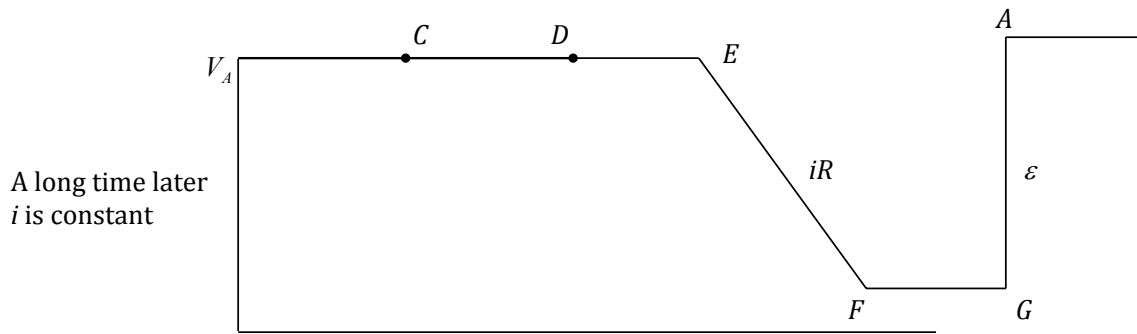

$$i(t \rightarrow \infty) = \frac{\varepsilon}{R}$$

Note:

$$V_L = \varepsilon \text{ at } t=0, i=0$$

$$V_L = 0 \text{ at } t \rightarrow \infty, i = \frac{\varepsilon}{R}$$

The time variations are controlled by the characteristic time

$$\tau = \frac{L}{R} \text{ (verify that this has dimensions of time)}$$

and look like

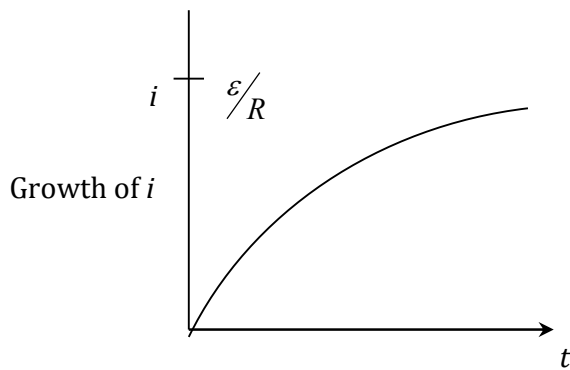

$$i = \frac{\varepsilon}{R} \left[1 - e^{-Rt/L} \right]$$

$$V_R = iR$$

$$= \varepsilon \left[1 - e^{-Rt/L} \right]$$

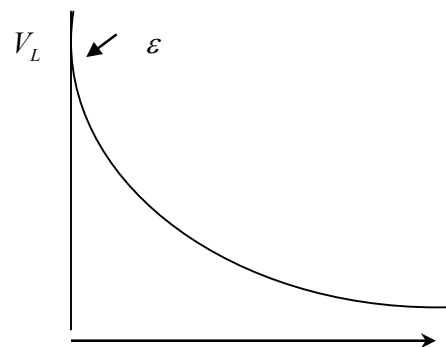

$$V_L = \varepsilon e^{-Rt/L}$$

After this long time $i = \frac{\mathcal{E}}{R}$ and a magnetic field has been established in L and stores $\frac{B^2}{2\mu_0}$ of energy per m^3 . So now if we move the switch so 1 \rightarrow 3 the circuit becomes

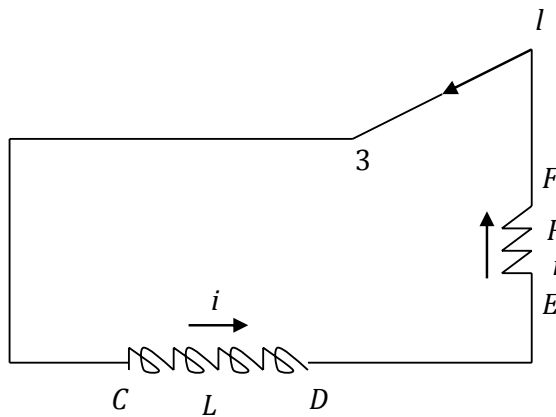

No Battery in circuit.
Magnetic Energy
stored in L is source of
current!

Let us start the clock again:

Step 1 $t=0$, $i = \frac{\mathcal{E}}{R}$ and the inductor wants to keep i going. Since $\frac{\Delta i}{\Delta t}$ is now -ive, V_L will be +ive and immediately jump to \mathcal{E} .

Step 2 As stored energy in L becomes smaller $\left| \frac{\Delta i}{\Delta t} \right|$ reduces with time.

Step 3 Long time later, all of the stored energy has been used up: $\frac{\Delta i}{\Delta t} \rightarrow 0$, $i \rightarrow 0$.

The time variations are

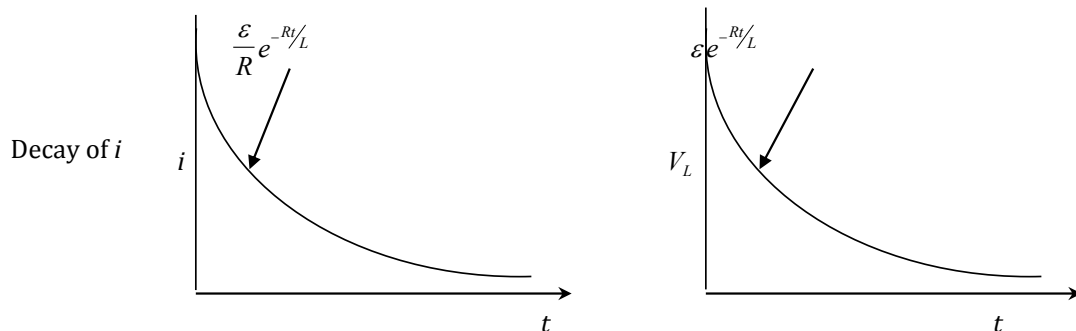

To Summarize:

- 1) L keeps $i = 0$ when switch first closed
- 2) $V_L \rightarrow 0$ as $t \rightarrow \infty$
- 3) in an L - R circuit potential precedes current.

QUESTION: Why does τ depend on both L and R ?

21.4 Exponential functions

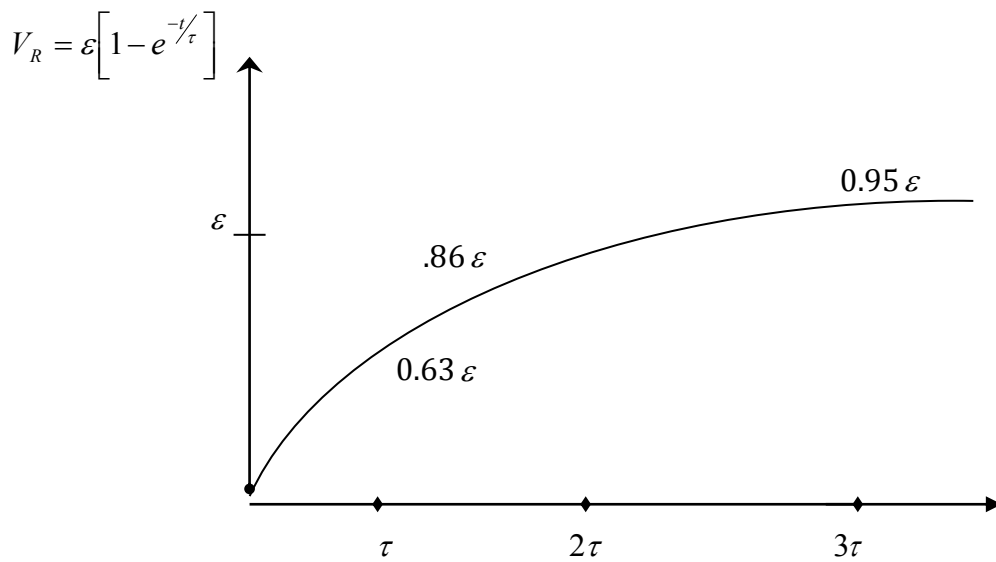
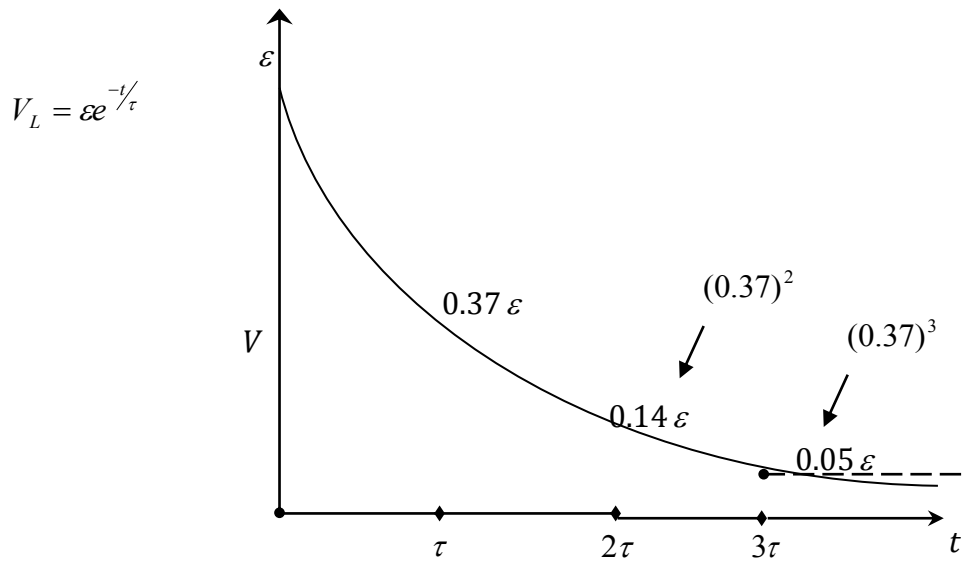

21.5 Devices – AC Generator

Take a coil of area $A(l \times b)$ mount it so that it can rotate freely about the y -axis in the presence of a constant $\underline{B} = B\hat{x}$. Rotate the coil about the y -axis at a constant angular velocity $\underline{\omega} = \omega\hat{y}$.

The flux of the \underline{B} -field through the coil is

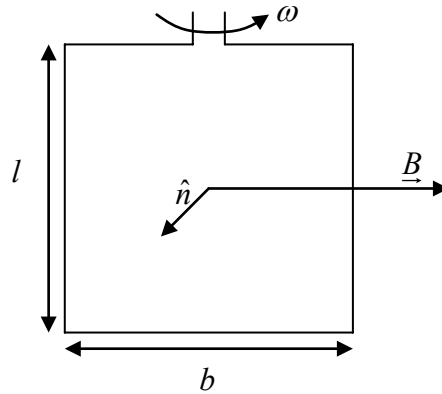

$$\begin{aligned} \Phi_B &= A\hat{n} \cdot \underline{B} \\ &= AB \cos(\hat{n}, \underline{B}) \end{aligned}$$

gaiteye
Challenge the way we run

EXPERIENCE THE POWER OF FULL ENGAGEMENT...

.....

**RUN FASTER.
RUN LONGER..
RUN EASIER...**

READ MORE & PRE-ORDER TODAY
WWW.GAITEYE.COM

As the coil rotates the angle between \hat{n} and \underline{B} will change continuously according to the equation

$$\mathcal{G} = \mathcal{G}_0 + \omega t$$

and therefore

$$\Phi_B = AB \cos(\mathcal{G}_0 + \omega t)$$

Let us make $\mathcal{G}_0 = 0$, that is, make $\hat{n} \parallel \underline{B}$ at $t = 0$.

Plot Φ_B as a function of time

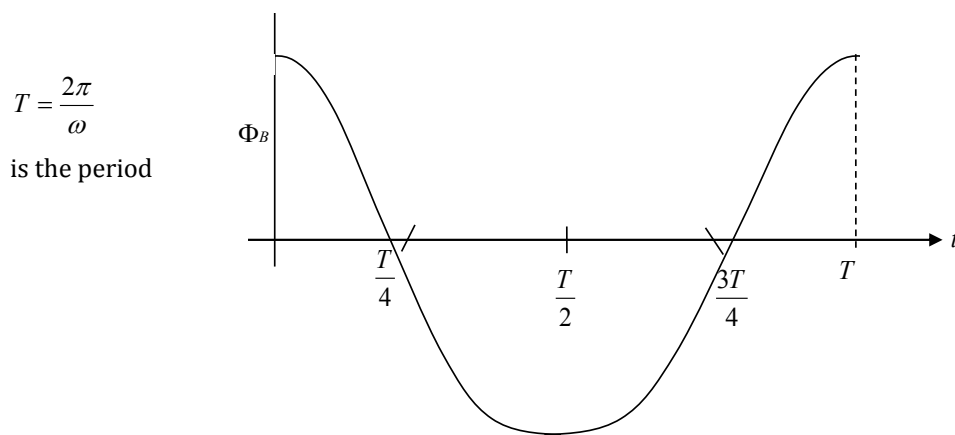

an $\mathcal{E}mf$ will appear in the coil according to

$$\mathcal{E} = -\frac{\Delta\Phi_B}{\Delta t}$$

which is the negative slope of the Φ_B vs. t curve

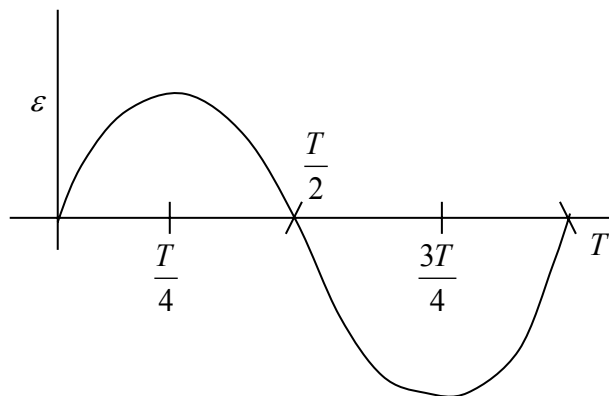

and we note

- 1) ε is maximum when Φ_B is zero and zero when Φ_B is maximum
- 2) As T reduces (ω increases) the slope gets larger and therefore it is reasonable to write

$$\varepsilon = AB\omega \sin \omega t$$

Such a rotating coil generates an εmf which reverses every $\frac{1}{2}$ cycle so it is an alternating current generator. This is the principle of all power generation – when you switch on your light, the bulb goes on because you complete a loop in which someone is causing the flux of \underline{B} to change by rotating a coil.

It is instructive to analyze the above device using the concept of motional εmf . As the coil rotates the vertical arms have velocities which vary from $v_z = \frac{b\omega}{2}$ [$\hat{n} \perp \underline{B}$] to zero when $\hat{n} \parallel \underline{B}$ so motional εmf goes from $\varepsilon_{\max} = \omega BA$ to zero. At other times the angle between \underline{v} and \underline{B} is also Θ [$\underline{v} \parallel \hat{n}$] so

$$\varepsilon = \omega BA \sin \omega t$$

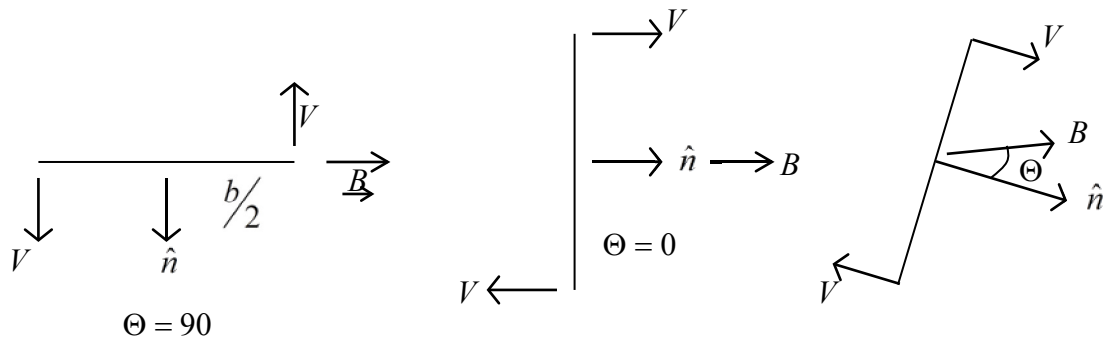

which is exactly the answer claimed above by using the Faraday-Lenz equation.

22 Devices – Ac Circuits

Battery Source of Coulomb \vec{E} -field

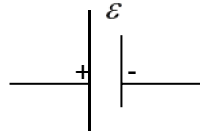

Output is *emf*: ε

Capacitor: Container for \vec{E} -field $C = \frac{Q}{V}$

Potential Energy $U_E = \frac{Q^2}{2C}$

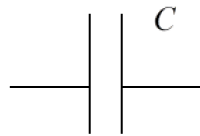

$\eta_E =$ Energy stored per $m^3 = \frac{1}{2} \epsilon_0 E^2$

$\epsilon_0 = 9 \times 10^{-12} F/m$

Resistor: Represents that it costs energy to transport charge through a conductor

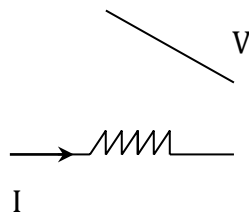

$R = \frac{V}{I} \quad \left[\begin{matrix} J = \sigma E \\ \vec{} = \sigma \vec{} \end{matrix} \right]$

Power loss $P = I^2 R = \frac{V^2}{R}$

Inductor: A time varying current causes a Non-Coulomb \vec{E} -field, or an induced *emf*, $L = \frac{-\varepsilon}{(\Delta i / \Delta t)}$

Container for \vec{B} -field, Potential Energy $U_B = \frac{1}{2} Li^2$

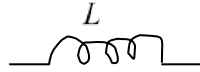

$$\eta_B = \text{Energy stored per } m^3 = \frac{B^2}{2\mu_0}$$

A.C. Generator: Wire loops of area A rotated at ω rad/s in a \vec{B} -field. Generates non-coulomb \vec{E} -field in the loops, produces an *emf*: $\varepsilon = \omega NBA \sin(\omega t)$

Where $N = \#$ of turns in the loop. Hence *ac-generator*

$$\Phi_B = NBA \cos(\Theta)$$

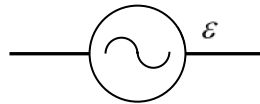

This e-book
is made with
SetaPDF





PDF components for PHP developers

www.setasign.com



Where Θ is angle between \hat{n} and \underline{B}

Rotation by ω rads/sec r makes $\Theta = \omega t$, $\Phi_B = NBA \cos(\Theta)$

$$\text{So } \frac{\Delta\Phi_B}{\Delta t} = -NBA\omega \sin \omega t, \quad \varepsilon = \frac{-\Delta\Phi_B}{\Delta t} = \omega NBA \sin \omega t$$

22.1 Circuits

I. RC with battery, close switch at $t=0$, current flows immediately, potential across C appears later

$$\varepsilon = \frac{q}{C} + iR$$

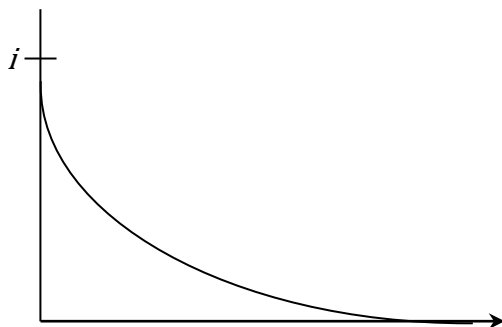
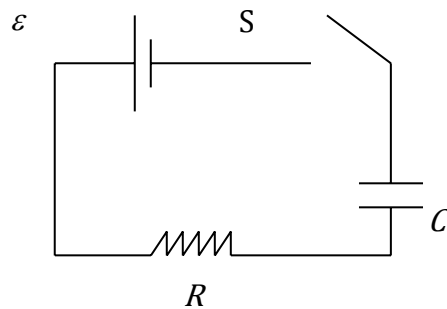

$$i = \frac{\varepsilon}{R} e^{-t/RC}$$

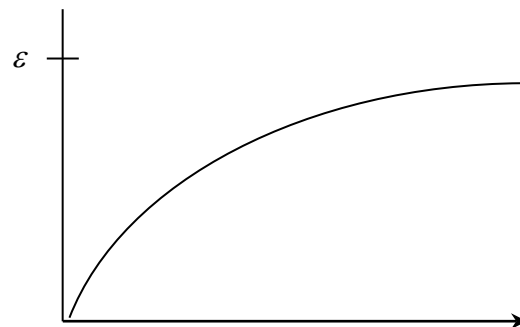

$$v_c = \varepsilon \left[1 - e^{-t/RC} \right]$$

N.B. Current first, voltage later.

22.2 RL With Battery

Close switch at $t=0$, v_L immediately jumps to $|\varepsilon|$

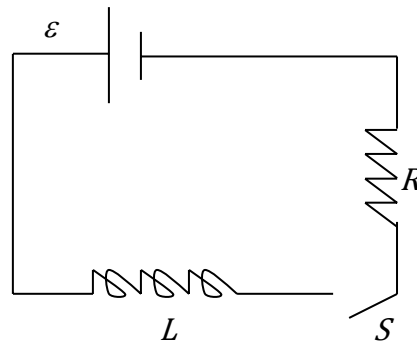

Current builds slowly.

$$\varepsilon = L \frac{\Delta i}{\Delta t} + iR$$

www.sylvania.com

We do not reinvent
the wheel we reinvent
light.

Fascinating lighting offers an infinite spectrum of possibilities: Innovative technologies and new markets provide both opportunities and challenges. An environment in which your expertise is in high demand. Enjoy the supportive working atmosphere within our global group and benefit from international career paths. Implement sustainable ideas in close cooperation with other specialists and contribute to influencing our future. Come and join us in reinventing light every day.

Light is OSRAM

**OSRAM
SYLVANIA**

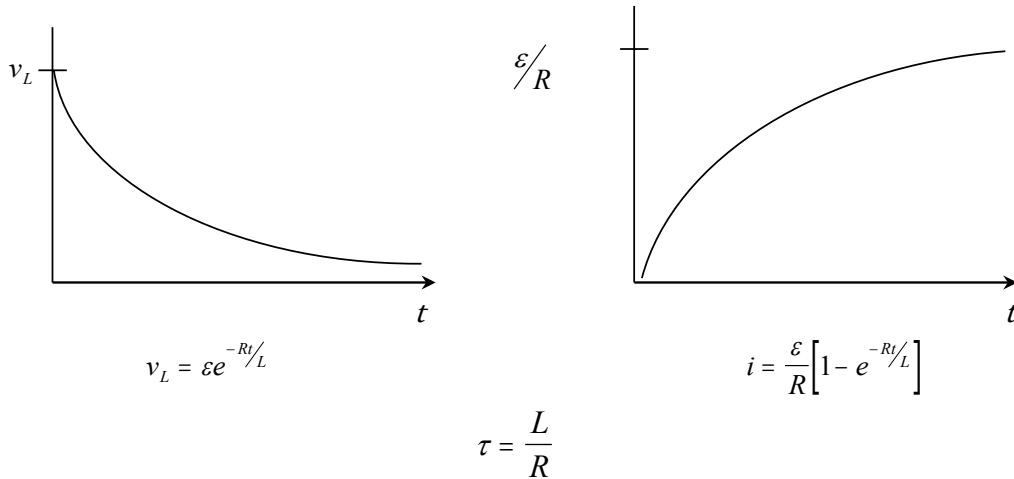

Note: Voltage First, Current Later.

26.2 LC-Circuit: Undamped Oscillator

First charge C to Q_0 . Close switch at $t=0$. Energy stored in capacitor $U_E = \frac{Q_0^2}{2C}$

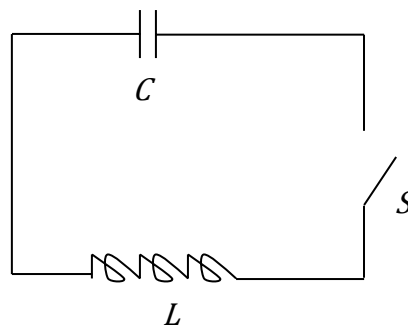

Charge begins to flow. Total Energy = (Energy in \vec{E} -field) + (Energy in \vec{B} -field)

$$= (\text{Energy in } C) + (\text{Energy in } L)$$

$$\frac{Q_0^2}{2C} = \frac{q^2}{2C} + \frac{1}{2}L\left(\frac{\Delta q}{\Delta t}\right)^2$$

Recognize, similarity to spring-mass oscillator

$$\frac{1}{2}kx^2 = \frac{1}{2}kx^2 + \frac{1}{2}m\left(\frac{\Delta x}{\Delta t}\right)^2$$

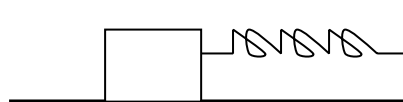

$x \rightarrow q$ $x = A \cos \omega_0 t$

$m \rightarrow L$ $\omega_0 = \sqrt{\frac{k}{m}}$

$k \rightarrow \frac{1}{C}$

$$q = Q_0 \cos \omega_0 t$$

Now

$$\omega_0 = \frac{1}{\sqrt{LC}}$$

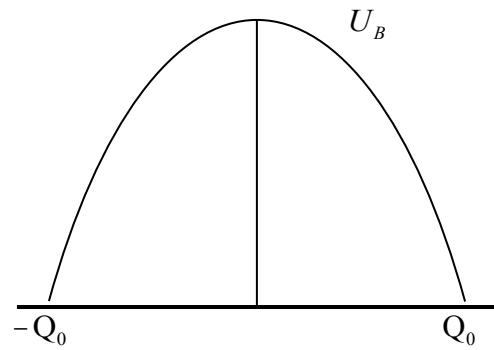
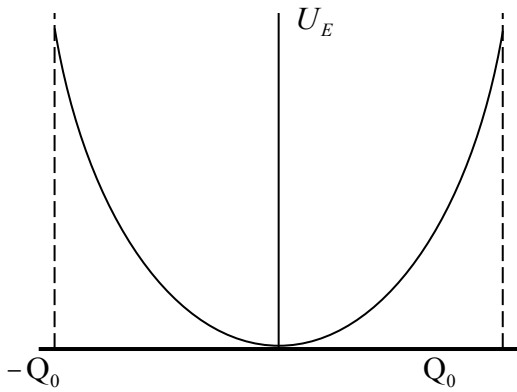

\vec{E} -field collapses giving rise to \vec{B} -field and vice versa.

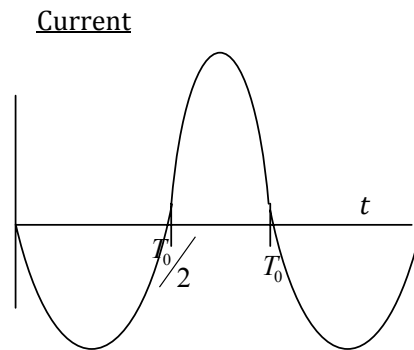
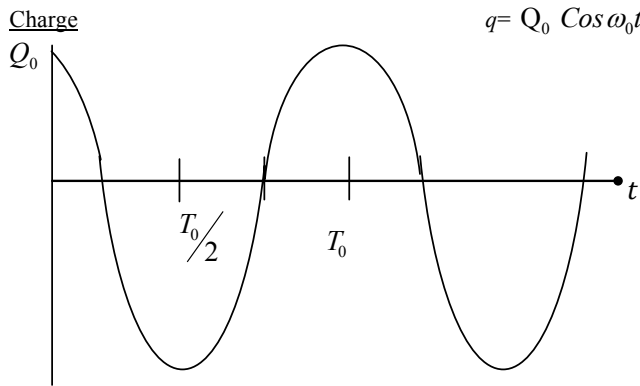

$$i = -Q_0 \omega_0 \sin \omega_0 t$$

$$\text{Period } T = \frac{2\pi}{\omega_0}$$

22.4 LCR-CIRCUIT: DAMPED OSCILLATOR

At $t=0$, charge C to Q_0 close switch. Now driving i through R costs $i^2 R$ per second.

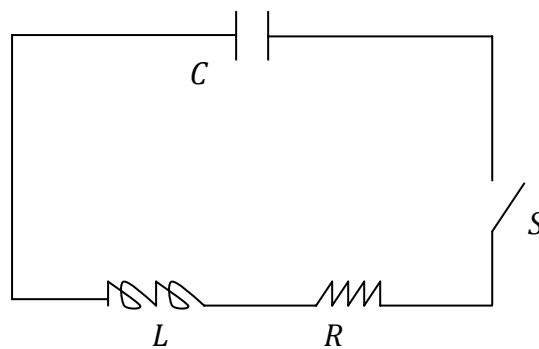

So $\left(\frac{q^2}{2C} + \frac{1}{2}Li^2\right)$ IS NOT CONSTANT

$$\frac{\Delta\left(\frac{q^2}{2C} + \frac{1}{2}Li^2\right)}{\Delta t} = -i^2R$$

-ive sign on right because energy is being lost (R is getting warmer).

Now $q = Q_0 e^{-Rt/2L} \cos \omega t$

$$\omega = \omega_0 \left[1 - \frac{1}{(2\omega_0\tau)^2} \right]^{\frac{1}{2}}$$

$$\tau = \frac{L}{R}$$

$\omega_0\tau = \text{Quality factor} = Q_e$



Discover the truth at www.deloitte.ca/careers

Deloitte.

© Deloitte & Touche LLP and affiliated entities.



Click on the ad to read more

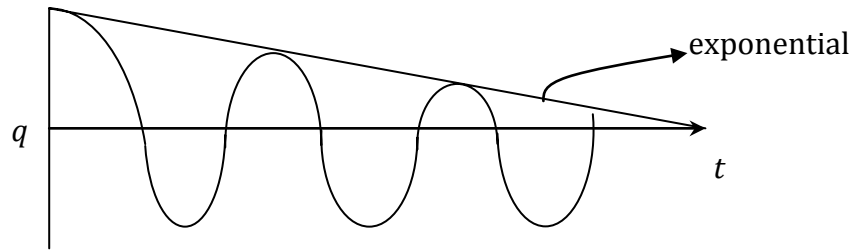

Note 1: smaller R , larger the duration for which the oscillations persist.

Note 2: R plays role of friction; as always energy lost goes to raise temperature. Electrical Equivalent of Heat.

22.4 Circuits: AC

1. Resistor and Generator

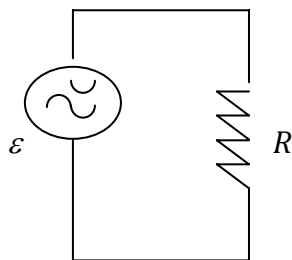

$$V_R = R$$

so

$$\text{If } \varepsilon = \varepsilon_0 \sin \omega t$$

$$i = \frac{\varepsilon_0}{R} \sin \omega t$$

Current and voltage are in phase.

Power

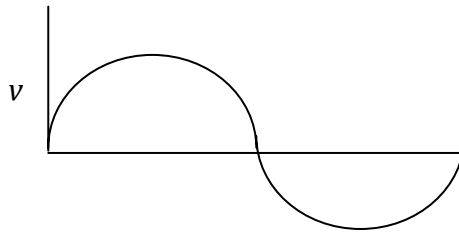

$$P(t) = iv$$

$$= \frac{\epsilon_0}{R} \text{Sin}^2 \omega t$$

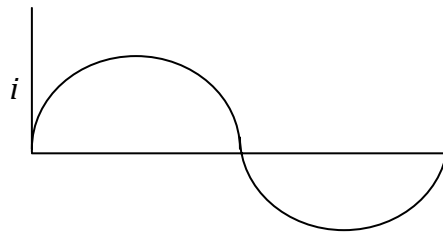

averaged over a cycle. $\langle P \rangle = \frac{\epsilon_0^2}{2R} = \frac{i_0 \epsilon_0}{2} = \frac{i_0^2 R}{2}$ and the power loss is as if R was connected to a battery whose $\epsilon = \frac{\epsilon_0}{\sqrt{2}}$. In this sense one talks of $\frac{\epsilon_0}{\sqrt{2}}$ and $\frac{i_0}{\sqrt{2}}$ as root-mean-square or r.m.s. voltage and current.

II. Generator and Capacitor

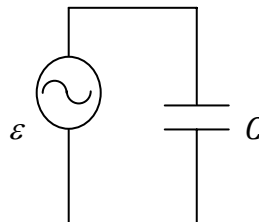

now $q=Cv$

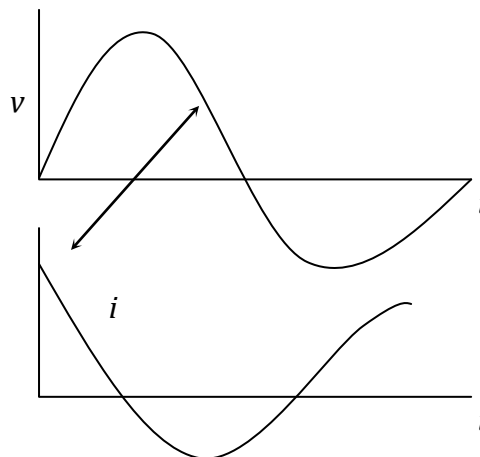

so charge and voltage in phase.

$$v = \varepsilon_0 \sin \omega t$$

$$q = \varepsilon_0 \sin \omega t$$

$$i = \frac{\Delta q}{\Delta t} = + \varepsilon_0 C \omega \cos \omega t$$

i and v are not in phase i leads v by $\pi/2$

$\frac{1}{\omega C}$ has dimensions of R and we define capacitive reactance

$$X_c = \frac{1}{\omega C}$$

$$i = \frac{\varepsilon_0}{X_c} \cos \omega t$$

$$\text{Now } P(t) = \frac{\varepsilon_0^2}{X_c} \sin \omega t \cos \omega t$$

$$\text{Average } \langle P \rangle = 0$$

No power loss on average.

SIMPLY CLEVER

ŠKODA



We will turn your CV into
an opportunity of a lifetime



Do you like cars? Would you like to be a part of a successful brand?
We will appreciate and reward both your enthusiasm and talent.
Send us your CV. You will be surprised where it can take you.

Send us your CV on
www.employerforlife.com



Click on the ad to read more

III.

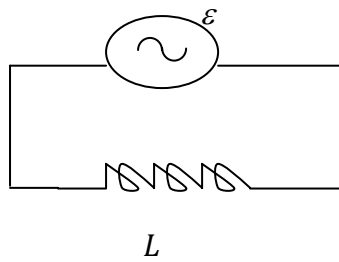

Now voltage in phase with slope of i vs t curve.

$$\text{If } i = i_0 \sin \omega t$$

$$\varepsilon - \frac{L \Delta i}{\Delta t} = 0$$

$$v_L = \frac{L \Delta i}{\Delta t}$$

$v_L = i_0 \omega L \cos \omega t$ and now voltage leads current by $\frac{\pi}{2}$

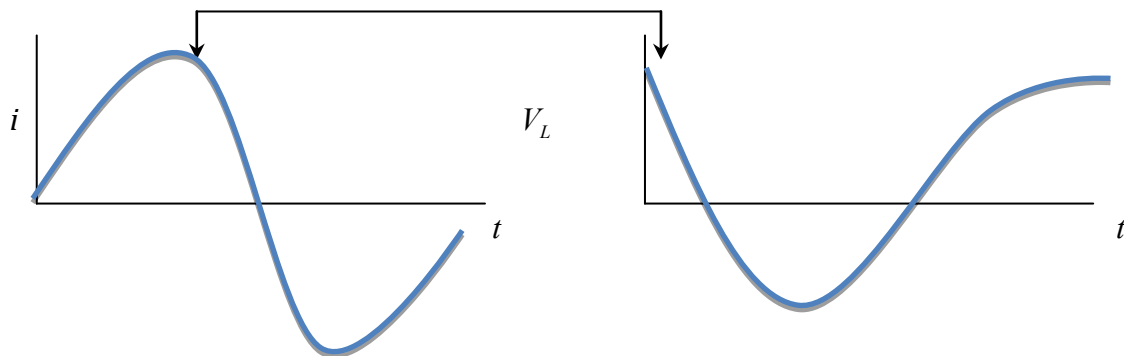

$$X_L = \omega L$$

And again $\langle P \rangle = 0$

22.5 Generator with all three

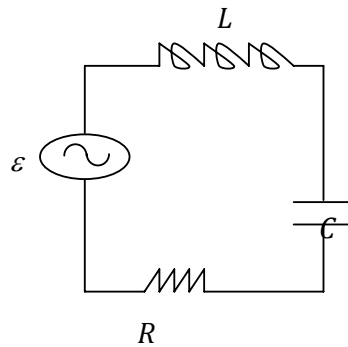

To work out behavior of L-C-R circuit we have to keep track of the relative phases in R, C, and L.

We introduce the concept of a Phasor. We have a series loop so current has to be same at all points. We begin with the current and build the voltage vector.

Take $i = i_0 \sin \omega t$ and represent it by current Phasor: vector of magnitude i_0 rotating at angular velocity ω , i.e.

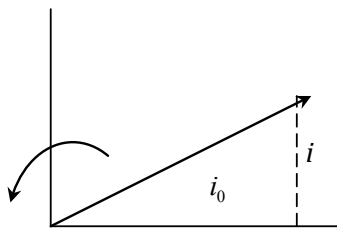

Concentrate on $t=0$

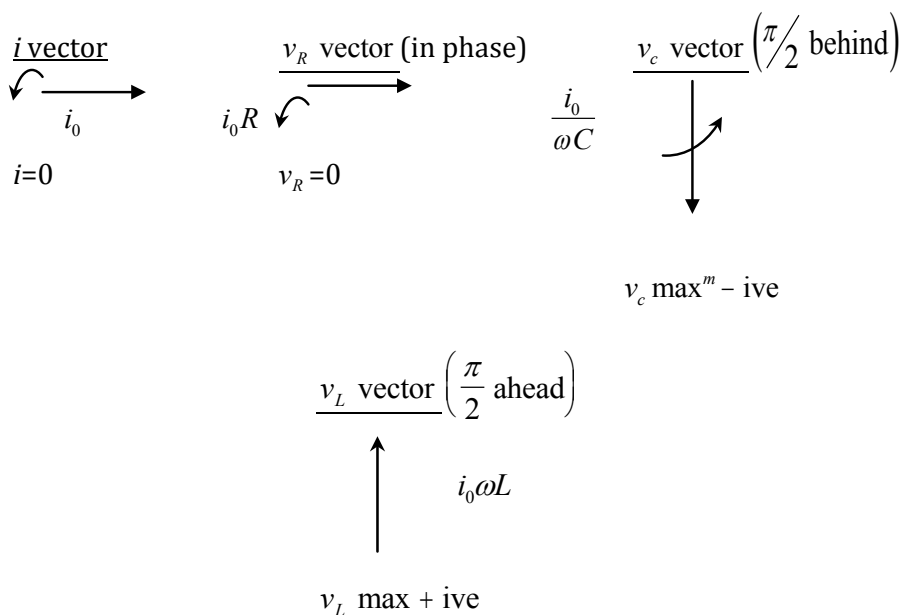

Total voltage vector

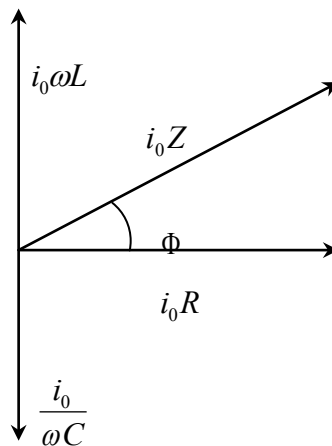

$$\varepsilon_0 = v_0 = i_0 \left[R^2 + \left(\omega L - \frac{1}{\omega C} \right)^2 \right]^{1/2}$$

$$\tan \Phi = \frac{\omega L - \frac{1}{\omega C}}{R}$$

$$i = i_0 \sin \omega t$$

$$v = \varepsilon_0 \sin(\omega t + \Phi)$$

I joined MITAS because
I wanted **real responsibility**

The Graduate Programme
for Engineers and Geoscientists
www.discovermitas.com



Month 16

I was a construction supervisor in the North Sea advising and helping foremen solve problems

Real work
International opportunities
Three work placements



Click on the ad to read more

Power in Circuit

$$P = iv = i_0 \epsilon_0 \sin \omega t \sin(\omega t + \phi)$$

$$= i_0 \epsilon_0 \left[\sin^2 \omega t \cos \phi + \sin \omega t \cos \omega t \sin \phi \right]$$

$$\langle P \rangle = \frac{i_0 \epsilon_0}{2} \cos \phi$$

This is the concept of Power factor $\cos \phi$

Next, Define Impedance

$$Z = \sqrt{R^2 + \left(\omega L - \frac{1}{\omega C} \right)^2}$$

then $i_0 = \frac{\epsilon_0}{Z}$ & $\cos \phi = \frac{R}{Z}$

so $\langle P \rangle = \frac{\epsilon_0^2}{2Z} \cos \phi = \frac{\epsilon_0^2}{2R} \cos^2 \phi$

RESONANCE If generator frequency can be varied $i_0 = \frac{\epsilon_0}{\sqrt{R^2 + \left(\omega L - \frac{1}{\omega C} \right)^2}}$

Gives $i_0 \rightarrow 0$ when $\omega \rightarrow 0$ b/c $\frac{1}{\omega C} \rightarrow \infty$ [capacitor cuts off i_0]

$i_0 \rightarrow 0$ when $\omega \rightarrow \infty$ b/c $\omega L \rightarrow \infty$ [Inductor cuts off i_0]

i_0 is max^m when $\omega L = \frac{1}{\omega C}$, $\omega_0 = \frac{1}{\sqrt{LC}}$

This is the phenomenon of Resonance

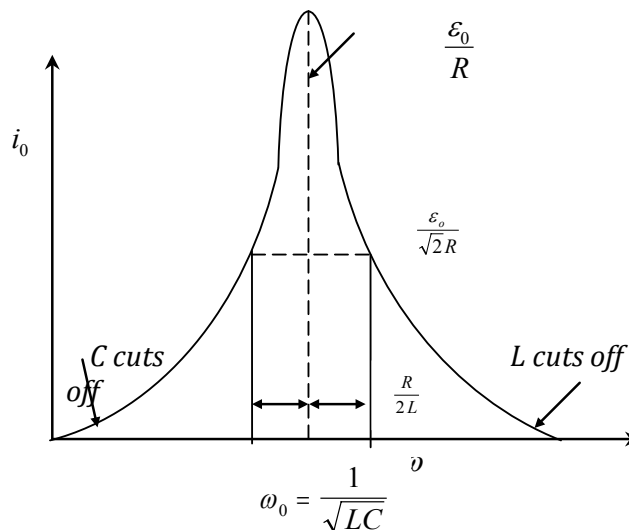

The phase difference ϕ is also a function of frequency

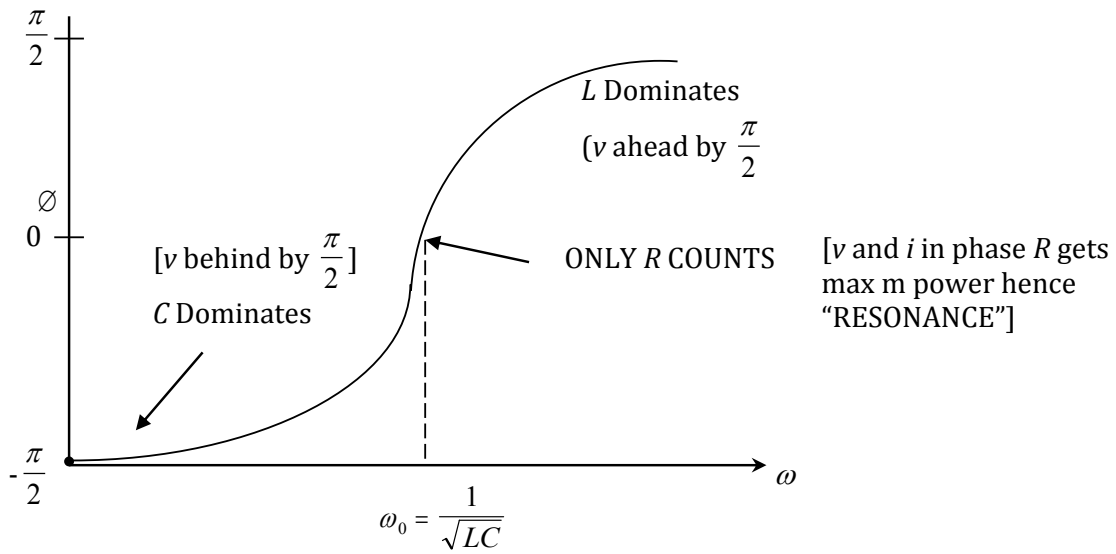

Note: Resonance occurs when Generator frequency ω is equal to natural frequency of LC Circuit

$$\omega_0 = \frac{1}{\sqrt{LC}}$$

Width of resonance $\Delta\omega = \frac{R}{L}$

$$Q = \frac{\omega_0}{\Delta\omega} = \frac{\omega_0 L}{R}$$

Series

i - common

V'S add.

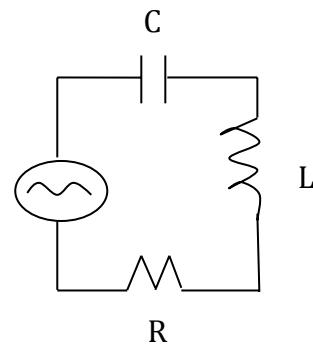
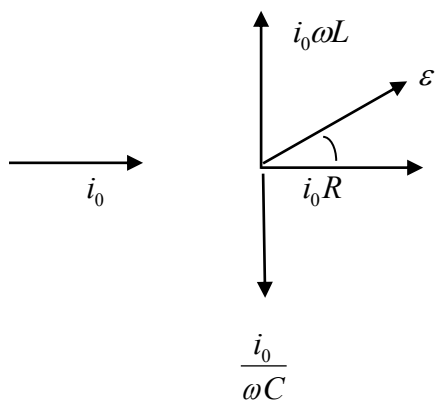

$$\epsilon_0 = i \sqrt{R^2 + \left(\omega L - \frac{1}{\omega c} \right)^2}$$

$$\epsilon = \epsilon_0 \sin(\omega t + \theta)$$

$$i = \frac{\epsilon_0}{\sqrt{R^2 + \left(\omega L - \frac{1}{\omega c}\right)^2}}$$

$$i = i_0 \sin \omega t$$

$$\tan \theta = \frac{\omega L - \frac{1}{\omega c}}{R}$$

$$\frac{\epsilon_0}{i_0} = z$$

Resonance

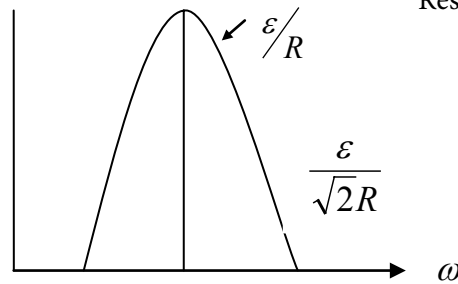

$$\omega_0 = \frac{1}{\sqrt{LC}}$$

$$\omega_0 + \Delta\omega \quad \frac{\epsilon}{\sqrt{2}R} = \frac{\epsilon}{\sqrt{R^2 + \left(\omega L - \frac{1}{\omega c}\right)^2}}$$



ie business school

#1 EUROPEAN BUSINESS SCHOOL
FINANCIAL TIMES 2013



#gobeyond

MASTER IN MANAGEMENT

Because achieving your dreams is your greatest challenge. IE Business School's Master in Management taught in English, Spanish or bilingually, trains young high performance professionals at the beginning of their career through an innovative and stimulating program that will help them reach their full potential.

- Choose your area of specialization.
- Customize your master through the different options offered.
- Global Immersion Weeks in locations such as London, Silicon Valley or Shanghai.

Because you change, we change with you.

www.ie.edu/master-management
mim.admissions@ie.edu









$$2R^2 = R^2 + \left(\omega L - \frac{1}{\omega c} \right)^2$$

$$R = \omega L - \frac{1}{\omega c} \qquad \omega_0 \left[1 - \frac{\Delta\omega}{\omega_0} \right]$$

$$R = (\omega_0 + \Delta\omega)L - \frac{1}{(\omega_0 - \Delta\omega)c}$$

$$= \omega_0 L + \Delta\omega L - \frac{1}{\omega_0 c} \left[1 - \frac{\Delta\omega}{\omega_0} \right]$$

$$R = \omega_0 L + \Delta\omega L - \frac{1}{\omega_0 c} + \frac{\Delta\omega}{\omega_0^2 L c^2}$$

$$\frac{R}{L} = \omega_0 + \Delta\omega - \frac{1}{\omega_0 L c} + \frac{\Delta\omega}{\omega_0^2 L c}$$

$$= \Delta\omega + \Delta\omega \qquad \omega_0^2 L c = 1$$

$$\Delta\omega = \frac{R}{2L}$$

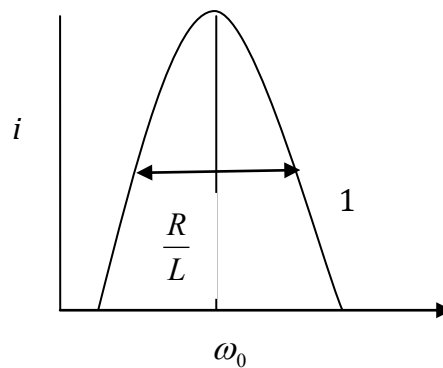

$$Q = \frac{\omega_0}{\Delta\omega}$$

$$= \frac{\omega_0 L}{R}$$

Parallel: ε common

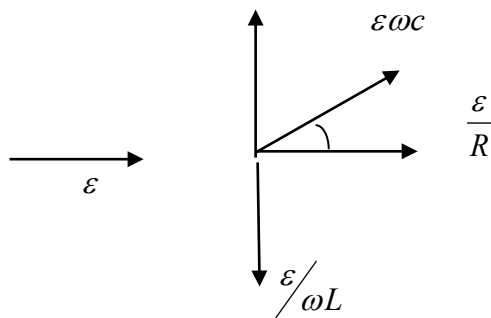
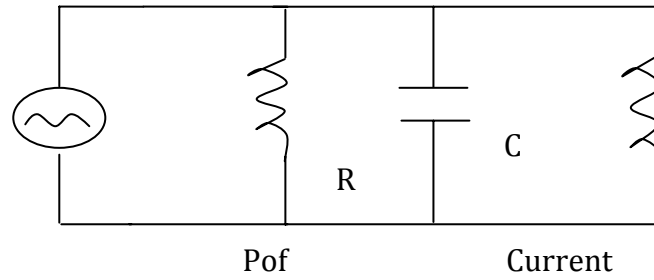

$$i = \varepsilon \sqrt{\frac{1}{R^2} + \left(\omega C - \frac{1}{\omega L} \right)^2}$$

$$\tan \theta = \frac{\omega C - \frac{1}{\omega L}}{\frac{1}{R}}$$

$$= R \left[\omega C - \frac{1}{\omega L} \right]$$

Look at

$$A = \frac{1}{\sqrt{\frac{1}{R^2} + \left(\omega C - \frac{1}{\omega L} \right)^2}}$$

Current

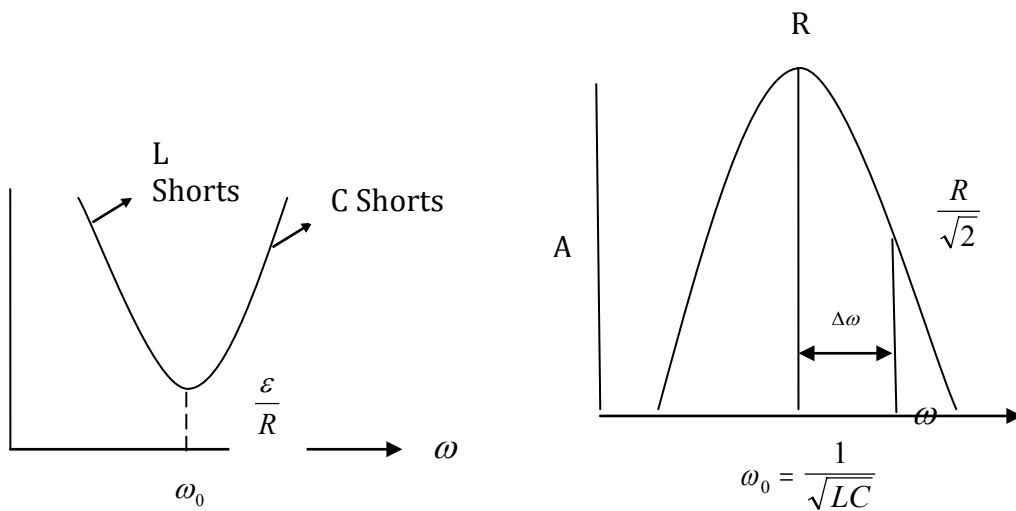

$$\frac{R}{\sqrt{2}} = \frac{1}{\sqrt{\frac{1}{R^2} + \left(\omega c - \frac{1}{\omega L}\right)^2}}$$

$$\frac{2}{R^2} = \frac{1}{R^2} + \left(\omega c - \frac{1}{\omega L}\right)^2$$

$$\frac{1}{R} = \omega c - \frac{1}{\omega L}$$

$$= (\omega_0 - \Delta\omega)c - \frac{1}{(\omega_0 - \Delta\omega)L}$$

$$= \omega_0 c + \Delta\omega c - \frac{1}{L\omega_0} \left[1 - \frac{\Delta\omega}{\omega_0}\right]$$

$$\frac{1}{RC} = \omega_0 + \Delta\omega - \frac{1}{Lc\omega_0} + \frac{\Delta\omega}{\omega_0^2 Lc}$$

$$= 2\Delta\omega$$

$$\text{So } \Delta\omega = \frac{1}{2RC}$$

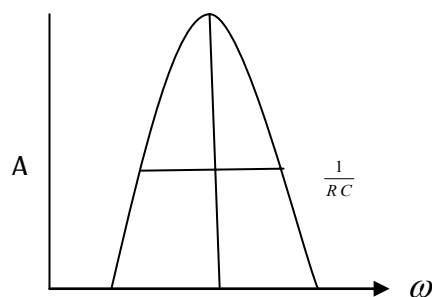

23 Maxwell's Equations: Radiation → Light

To summarize, the field Equations derived from Experiments are:

GAUSS' LAW FOR COULOMB E_{\rightarrow}

$$\Sigma_C E_{\rightarrow} \cdot \Delta A_{\rightarrow} = \frac{1}{\epsilon_0} \Sigma Q_i \quad (1)$$

GAUSS' LAW FOR B_{\rightarrow}

$$\Sigma_C B_{\rightarrow} \cdot \Delta A_{\rightarrow} \equiv 0 \quad (2)$$

LENZ'S LAW

$$\Sigma_C E_{NC} \cdot \Delta l_{\rightarrow} = - \frac{\Delta \Phi_B}{\Delta t} \quad (3)$$

AMPERE'S LAW

$$\Sigma_C B_{\rightarrow} \cdot \Delta l_{\rightarrow} = \mu_0 \Sigma I_i \quad (4')$$



STUDY AT A TOP RANKED INTERNATIONAL BUSINESS SCHOOL

Reach your full potential at the Stockholm School of Economics, in one of the most innovative cities in the world. The School is ranked by the Financial Times as the number one business school in the Nordic and Baltic countries.

Visit us at www.hhs.se





When Maxwell began to study these equations, he realized that there was a serious problem. Scientists believe that at its most fundamental level nature must be symmetric. Maxwell noticed that whereas a time varying flux of \vec{B} gave rise to an \vec{E} -field $\left[\vec{E}_{NC} \text{ in Eq. (3)} \right]$ there was no corresponding term in Eq. (4'). He immediately asserted that the above field equations could not be regarded as being complete. This was a **FUNDAMENTAL PROBLEM** Maxwell also noted a “PRACTICAL PROBLEM” in using Eq. (4). Imagine that we charge a capacitor to $\pm q$ and then connect a wire between the two plates as shown.

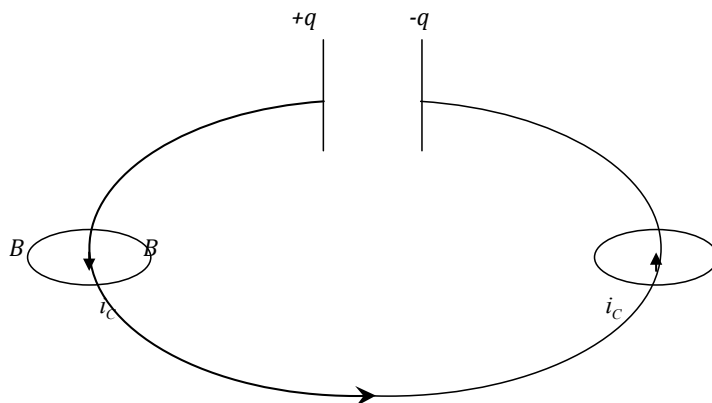

$$i_C = \frac{\Delta q}{\Delta t}$$

It is clear that a conduction current $\frac{\Delta q}{\Delta t}$ begins to flow through the wire and so [using Eq. (4')] it must create a \vec{B} -field encircling the wire as shown. However, as soon as you cross one of the capacitor plates, both the current and \vec{B} must be zero. Again, Maxwell asserted that such a discontinuity cannot be physically meaningful.

To resolve the fundamental problem Maxwell **postulated** that if the flux of \vec{E} varies with time it must be equivalent to a current. He called this new type of current a displacement current and introduced the definition $i_D = \epsilon_0 \frac{\Delta \phi_E}{\Delta t}$ (5)

Of course, Eq. (4') implies that every current generates a \vec{B} so Maxwell “completed” Eq. (4') by writing

$$\sum_C \vec{B} \cdot \Delta \vec{l} = \mu_0 \sum I_C + \mu_0 \epsilon_0 \frac{\Delta \phi_E}{\Delta t} \tag{4}$$

Where I_C explicitly signifies a conduction current = flow of charge in a conductor while the second term on the right comes from i_D [Eq. (5)].

Let us see if introduction of i_D also solves the practical problem. If the capacitor plates have an area A the \vec{E} -field between them is

$$\vec{E} = \frac{q}{\epsilon_0 A} \hat{x}, \quad A = A \hat{x}$$

so $\Phi_E = \frac{q}{\epsilon_0}$

and $i_D = \epsilon_0 \frac{\Delta \Phi_E}{\Delta t} = \frac{\Delta q}{\Delta t} = i_C!$

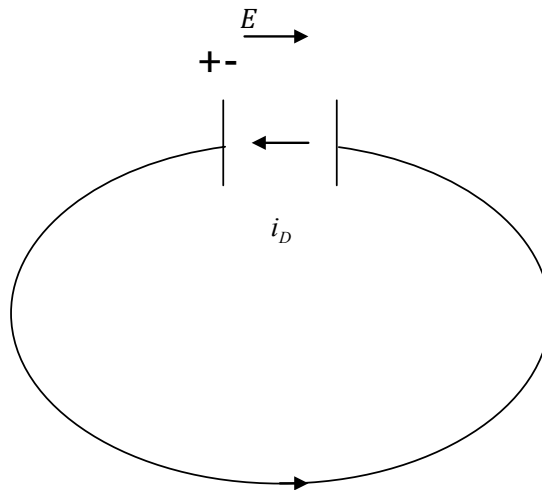

#1
in eco-friendly
attitude

**STUDY AT
LINKÖPING UNIVERSITY, SWEDEN**
RANKED AMONG TOP 50 UNIVERSITIES UNDER 50

Interested in Strategy and Management in International Organisations? Kick-start your career with a master's degree from Linköping University, Sweden.

→ **Click here!**

 **Linköping University**

$[i_D$ is from -ive to +ive because of $\frac{\Delta q}{\Delta t}$ is -ive]

Since $i_D = i_C$ we will have **no** discontinuity in either the current or the \underline{B} -field on crossing the capacitor plate.

Maxwell has solved both the fundamental and the practical problem by proposing Eq. (5).

Note: i_D is purely a product of Maxwell's brain. It is an example of the second, more basic, content of Physics.

23.1 Maxwell's Equations

Gauss' Law for Coulomb \underline{E} :

Since a stationary charge generates a Coulomb \underline{E} field, the TOTAL flux of \underline{E}_{Coul} THROUGH a closed surface is determined solely by the charges located in the volume enclosed by that surface.

$$\Sigma_C \underline{E}_{Coul} \bullet \underline{\Delta A} = \frac{1}{\epsilon_0} \Sigma Qi \quad (1)$$

Gauss' Law for \underline{B} :

Since the elementary generators of \underline{B} are point magnetic dipoles the TOTAL flux of \underline{B} THROUGH a closed surface is always **ZERO**:

$$\Sigma_C \underline{B} \bullet \underline{\Delta A} \equiv 0 \quad (2)$$

Faraday – Lenz Law:

If the flux of \underline{B} varies with time a Non-Coulomb \underline{E} field will appear in every closed “loop” surrounding the region where the flux of \underline{B} is varying. The sense of \underline{E}_{NC} is invariably such as to oppose the variation in the flux of \underline{B} that causes it. Hence, circulation of \underline{E}_{NC} around a close loop is determined by the time rate of change of flux of \underline{B} through the area within the loop; [Note: Crucial negative sign]:

$$\Sigma \underline{E}_{NC} \bullet \underline{\Delta l} = - \frac{\Delta \Phi_B}{\Delta t} \quad (3)$$

Maxwell – Ampere Law:

Every current generates a \underline{B} field that circulates around it. There are two types of current: (i) Conduction current which involves flow of charge in a conductor and (ii) displacement current which arises when flux of \underline{E} field varies with time. Hence, Circulation of \underline{B} around a closed loop is determined by currents threading the surface on which the loop is drawn.

$$\Sigma_C \underline{B} \bullet \underline{\Delta l} = \mu_0 \Sigma I_c + \mu_0 \epsilon_0 \frac{\Delta \Phi_E}{\Delta t} \quad (4)$$

CAUTION: i_D exists in vacuum. It never involves flow of charge. No conduction current can exist inside the capacitor!!!

Maxwell's *Equations (1) through (4)* have profound consequences. Let us recall his work using these in outer space, where there is vacuum, $q=0$, $i_C = 0$ so the Equations become:

$$\Sigma_C \vec{E} \cdot \Delta \vec{A} = 0 \quad I$$

$$\Sigma_C \vec{B} \cdot \Delta \vec{A} = 0 \quad II$$

$$\Sigma_C \vec{E}_{NC} \cdot \Delta \vec{l} = - \frac{\Delta \phi_B}{\Delta t} \quad III$$

$$\Sigma_C \vec{B} \cdot \Delta \vec{l} = \mu_0 \epsilon_0 \frac{\Delta \phi_E}{\Delta t} \quad IV$$

and now indeed there is total symmetry with respect to \vec{E} and \vec{B} . This is what led Maxwell to propose that rather than think of \vec{E} and \vec{B} fields, one should think of a single entity:

23.2 Electromagnetic or EM field

And call *Equations I through IV*, EM field Equations. He next used these Equations to **predict** that in vacuum there must exist **EM-waves!** He was able to show that the structure of these Equations is such that both the \vec{E} and \vec{B} have the functional form (propagation along x for example) $f(x \pm ct)$. That is, they propagate as an Electromagnetic wave with the enormous speed $c = \frac{1}{\sqrt{\mu_0 \epsilon_0}} = 3 \times 10^8 \text{ m/s}$. This

was a giant step forward: Maxwell had solved the problem of the nature of Radiation or Radiant energy. \Rightarrow Radiation is an Electromagnetic wave. **Our observable universe = Matter + Radiation**

Incidentally, Einstein demonstrated that matter and radiation convert into one another there by further simplifying our picture of the universe.

→ Heat

→ Light

→ x-rays

→ radiowaves

are all cases of EM waves. They are distinguished only by their frequencies (or wavelengths). (see below)

23.3 Periodic EM Waves

As before a periodic EM wave will be represented by

$$\underline{E} = \underline{E}_m \sin\left(\frac{2\pi x}{\lambda} \pm \frac{2\pi t}{T}\right) = \underline{E}_m \sin(kx \pm \omega t) \quad (1)$$

and

$$\underline{B} = \underline{B}_m \sin\left(\frac{2\pi x}{\lambda} \pm \frac{2\pi t}{T}\right) = \underline{B}_m \sin(kx \pm \omega t)$$

with

$$k = \frac{2\pi}{\lambda}, \quad \omega = \frac{2\pi}{T} = 2\pi f \quad (2)$$

and the speed $v = \lambda f$ or $\omega = vk$ (3)

“I studied English for 16 years but...
...I finally learned to speak it in just six lessons”
Jane, Chinese architect

ENGLISH OUT THERE

Click to hear me talking before and after my unique course download

In vacuum EM-waves are totally transverse:

$$\underline{E}_m \perp \hat{x}$$

$$\underline{B}_m \perp \hat{x}$$

$$\underline{E}_m \perp \underline{B}_m$$

Indeed for a wave travelling in positive x direction $\underline{E}_m \parallel \hat{y}$ and $\underline{B}_m \parallel \hat{z}$

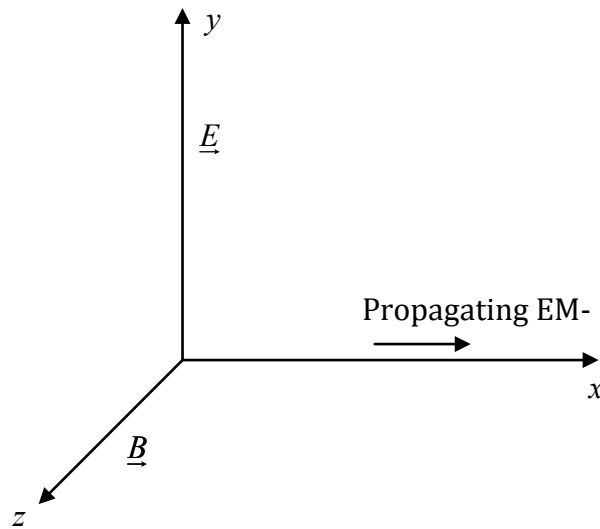

In vacuum EM-waves have an enormous speed (symbol c)

$$c = 3 \times 10^8 \text{ m/sec.} \quad (4)$$

In vacuum the \underline{E} and \underline{B} fields are related by the equation

$$E = cB \quad (5)$$

The EM wave also transports energy because energy is stored in the \underline{E} and \underline{B} fields. Earlier, we have proved that per m^3 the fields carry the energies

$$\eta_E = \frac{1}{2} \epsilon_0 E^2 \quad (6)$$

$$\eta_B = \frac{B^2}{2\mu_0} \quad (7)$$

Here, ϵ_0 and μ_0 are constants, roughly,

$$\epsilon_0 = 9 \times 10^{-12} \text{ F/m} \quad (8)$$

$$(\epsilon_0 \quad Q^2 M^{-1} L^{-3} T^{+2} \quad F/m \quad \text{Scalar})$$

$$\mu_0 = 4\pi \times 10^{-7} \text{ H/m} \quad (9)$$

$$(\mu_0 \quad MLQ^{-2} \quad H/m \quad \text{Scalar})$$

It is notable that speed of EM wave is

$$c = \frac{1}{\sqrt{\mu_0 \epsilon_0}}$$

so that, because of an Eq(5), in an EM wave

$$\eta_E = \eta_B \quad (10)$$

hence 1 m^3 of an EM-wave carries the energy

$$\eta_{EM} = \eta_E + \eta_B = \epsilon_0 E^2 = \frac{B^2}{\mu_0} \quad (11)$$

As in the case of sound we can calculate the intensity of an EM-wave by using (11).

Intensity = Energy Transported per Unit Area per Unit Time

So imagine a tube of cross-sectional area 1 m^2 "filled" with an EM wave.

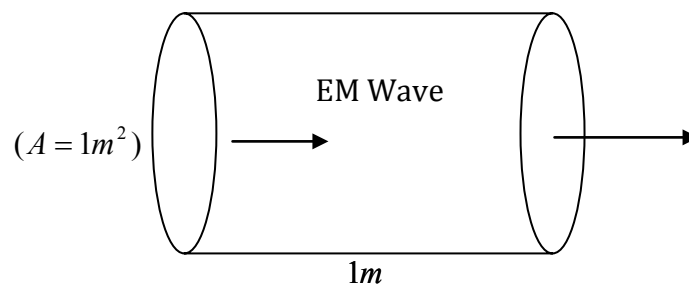

If its length is 1 m then at any instant the energy stored in it is

$$\eta_{EM} = \epsilon_0 E^2 = \frac{B^2}{\mu_0} \quad (12)$$

Where $E^2 = E_m^2 \sin^2(kx - \omega t)$

$$B^2 = B_m^2 \sin^2(kx - \omega t)$$

The average value of the energy will be

$$\begin{aligned} \langle \eta_{EM} \rangle &= \epsilon_0 E_m^2 \langle \sin^2(kx - \omega t) \rangle & (13) \\ &= \frac{B_m^2}{\mu_0} \langle \sin^2(kx - \omega t) \rangle \end{aligned}$$

But $\langle \sin^2(\) \rangle = \frac{1}{2}$

So

$$\langle \eta_{EM} \rangle = \frac{\epsilon_0 E_m^2}{2} = \frac{B_m^2}{2\mu_0} \quad (14)$$

In one second this energy will travel by c meters so energy transport per m^2 per second becomes

$$\langle I \rangle = \frac{c\epsilon_0 E_m^2}{2} = \frac{cB_m^2}{2\mu_0} \quad (15)$$

Excellent Economics and Business programmes at:



university of
 groningen



**“The perfect start
 of a successful,
 international career.”**

CLICK HERE
 to discover why both socially
 and academically the University
 of Groningen is one of the best
 places for a student to be

www.rug.nl/feb/education

From a practical point of view, if a point source of EM waves emits P joules/sec the intensity at a distance r will be

$$I = \frac{P}{4\pi r^2} (\text{watt} / \text{m}^2)$$

exactly as noted earlier for sound.

23.4 Spectrum of EM-Waves – Light

EM waves are essentially ubiquitous. The following table illustrates this point succinctly.

Name	Frequency	Wavelength (in vacuum)
AM Radio	100 kHz	kms
FM Radio	100 MHz	3m
TV – uHF	300 MHz	1m
Microwaves	1-100 GHz	0.1m – 0.003m
Infrared (Heat Radiation)	$10^{12} - 10^{13}$ Hz	10^{-5} m
Light	$10^{14} - 10^{15}$ Hz	400nm – 700nm
UV	$10^{16} - 10^{17}$ Hz	100nm
X-rays	10^{18} Hz	1nm
γ -rays	10^{20} Hz	1pm

To Summarize:

What is light?: Light is a transverse EM wave whose wavelength in vacuum (air) lies between 400nm and 700nm and speed in vacuum is 3×10^8 m / sec.

23.5 Compare Mechanical And Em Waves

Wave on a string: Power

$$P = \frac{1}{2} \mu A^2 \omega^2 v$$

$$v = \sqrt{\frac{F}{\mu}}$$

[Average Energy stored per unit length multiplied by velocity]

Sound: Intensity

$$I = \frac{1}{2} \rho_0 S_m^2 \omega^2 v$$

$$v = \sqrt{\frac{\gamma P_0}{\rho_0}}$$

[Average Energy stored per unit volume multiplied by velocity]

23.6 EM-wave Light: Intensity

$$I = \frac{B_m^2}{2\mu_0} c = \frac{1}{2} \epsilon_0 E_m^2 c$$

$$c = \sqrt{\frac{1}{\mu_0 \epsilon_0}}$$

In general, the propagation of a light wave is best visualized by using a construct due to Huygens'. As the light waves spread out of a point source at some time later they essentially form a spherical "wave front", a surface of constant phase. Huygens' proposed that one should treat each point of the wave front as a point source of light from which spherical wavelets emanate and a spherical surface tangent to all the wavelets locates the new wave front at a later instant. This is shown schematically in the figure. The direction of propagation is along the normal to the wave front – radial for a point source and if you include extinction coefficient $(1 + \cos \theta)$ no energy flows backward.

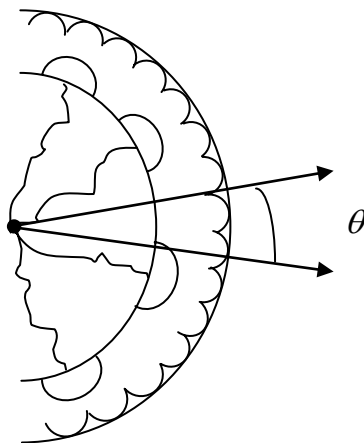

24 Geometrical Optics

Basis: We will learn that when light of wavelength λ passes through a slit of width w , diffraction causes it to spread by the angle Θ , given by

$$\sin \Theta_1 = \frac{\lambda}{w}$$

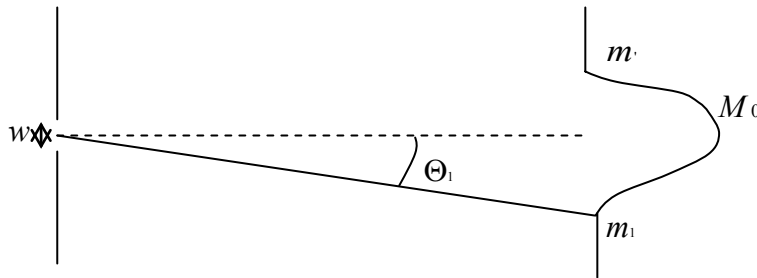

In the past four years we have drilled

89,000 km

That's more than **twice** around the world.

Who are we?
We are the world's largest oilfield services company¹. Working globally—often in remote and challenging locations—we invent, design, engineer, and apply technology to help our customers find and produce oil and gas safely.

Who are we looking for?
Every year, we need thousands of graduates to begin dynamic careers in the following domains:

- Engineering, Research and Operations
- Geoscience and Petrotechnical
- Commercial and Business

What will you be?

Schlumberger

careers.slb.com

¹Based on Fortune 500 ranking 2011. Copyright © 2015 Schlumberger. All rights reserved.



If w becomes much larger than λ , $\Theta_1 \rightarrow 0$ and this spread due to diffraction becomes negligible. In that case the propagation of light looks like the figure and on the screen we observe a patch of light of width w . Light appears to be propagating along a straight line and therefore its progress can be described by using geometry, hence

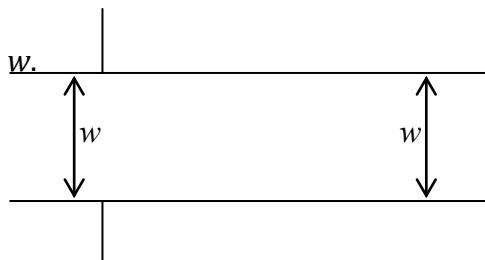

Geometrical optics and we talk of the path of light by labeling a light **RAY**.

So for now we say that if openings and obstacles are much larger than λ , Geometrical optics prevails.

As one begins with a point source where light would emerge radially. Near the source the spheres are small but far away they begin to look like “planes” and the light “rays” essentially become parallel to one another. The basic principle which governs the propagation of light in Geometrical optics is due to Fermat.

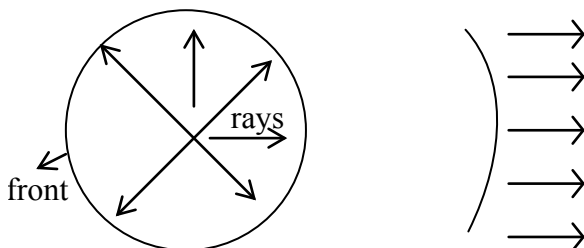

24.1 Fermat’s Principle: LIGHT INVARIABLY CHOOSES A PATH WHICH TAKES THE LEAST TIME OF TRAVEL

Unobstructed light therefore travels in **straight lines**.

Next, it is notable that speed of light is not the same in all media. Indeed

$$v = \frac{c}{n} \quad (c = \text{speed in vacuum})$$

where n is the refractive index. Previously, we learnt that when a wave arrives at a point where velocity changes it gives rise to two waves – Reflected wave travels back in original medium

Transmitted wave travels forward in next medium Light waves will do exactly the same

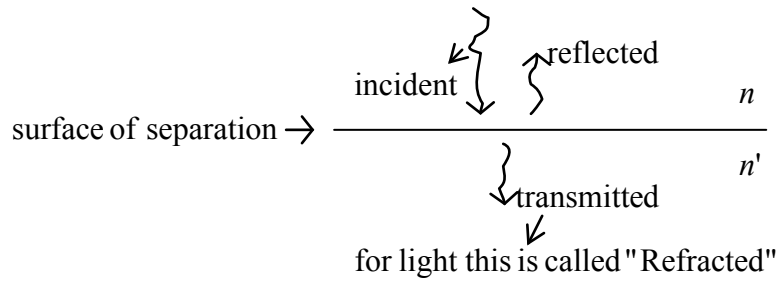

In the ray picture if light is travelling perpendicular to surface you get \longrightarrow

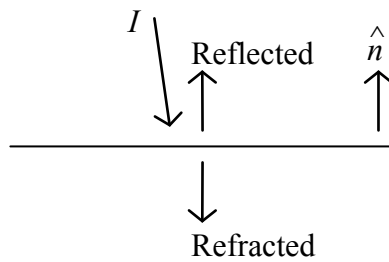

However, we are now interested in the more general case where path of light is not along \hat{n} the vector normal to the surface,

Note: Henceforth, **all angles are to be measured with respect to the NORMAL (\hat{n})**

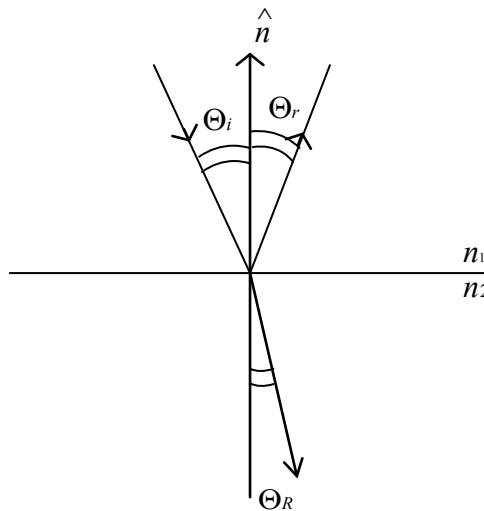

So now light is arriving at angle Θ_i . Fermat's principle controls the angles Θ_r (reflected ray) and Θ_R (refracted ray).

The **reflection** case is easy to understand using Fermat's Principle.

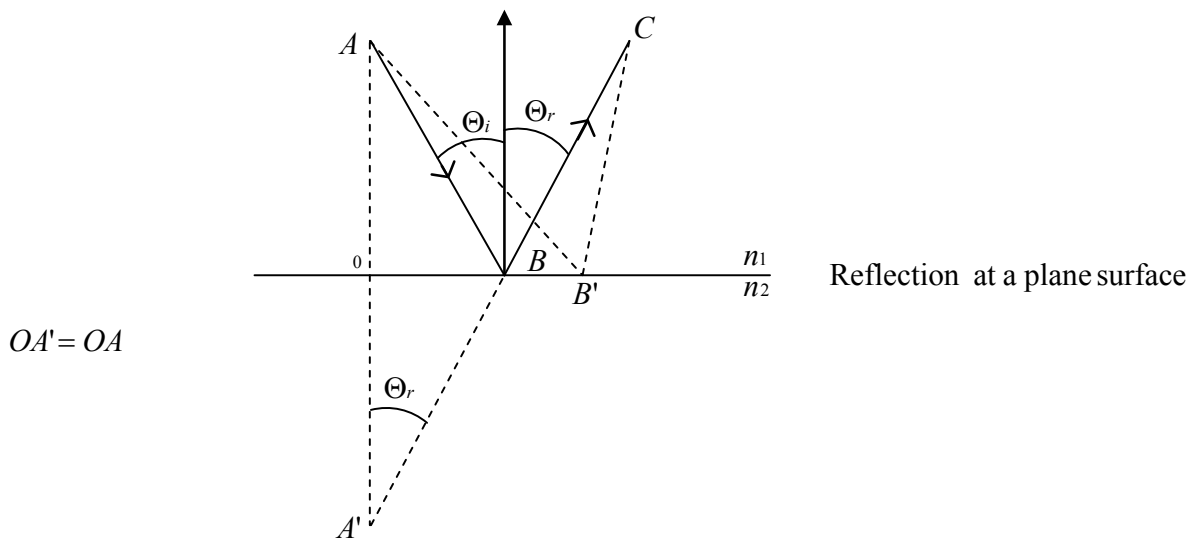

Notice that $A'BC$ is the shortest distance light will travel in going from A to C . All other paths are longer and therefore will take more time.

American online

LIGS University

is currently enrolling in the
Interactive Online **BBA, MBA, MSc,**
DBA and PhD programs:

- ▶ enroll **by September 30th, 2014** and
- ▶ **save up to 16%** on the tuition!
- ▶ pay in 10 installments / 2 years
- ▶ Interactive **Online** education
- ▶ visit www.ligsuniversity.com to find out more!

Note: LIGS University is not accredited by any nationally recognized accrediting agency listed by the US Secretary of Education. More info [here](http://www.ligsuniversity.com).





Hence we have law of reflection: Angle of reflection = angle of incidence

$$\Theta_r = \Theta_i$$

[Looks like the case of Elastic Collision with a wall that we analyzed in Phys I, x -component of \underline{p} reversed y -component stayed the same]

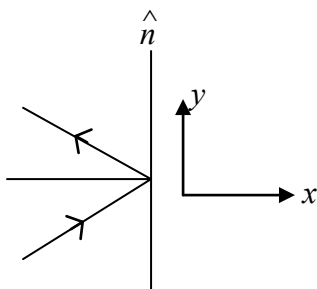

The path of the refracted ray is also determined by Fermat’s principle but the proof requires use of derivatives so we just write the answer called

24.2 Snell’s Law

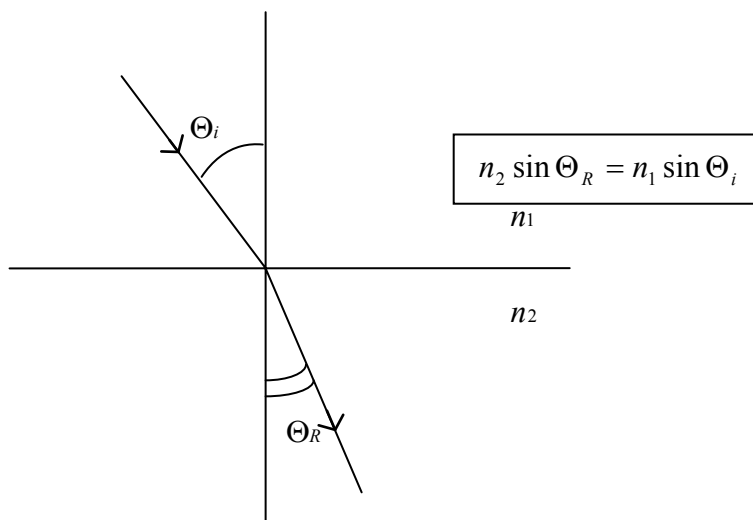

Product of refractive index and sine of the angle with respect to normal is a constant.

24.3 Some Applications

“Corner” Reflector – uses two mirrors, the mirror being a device where only reflections occur – a polished piece of metal, glass with silver coating.

Two mirrors at right angles to one another

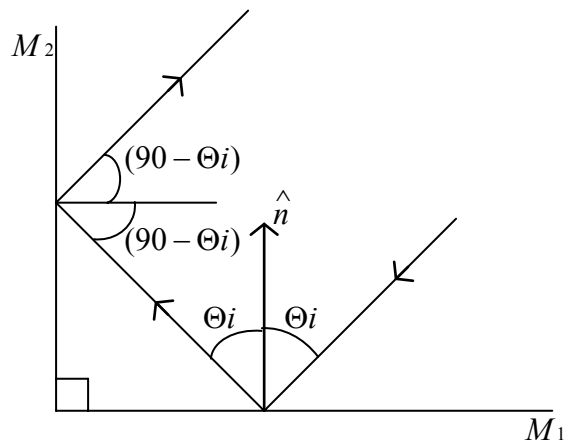

And from the figure above you can see that after the two reflections the light follows a path which is anti-parallel to the incident ray.

Refraction Through Parallel Plate – Lateral Shift

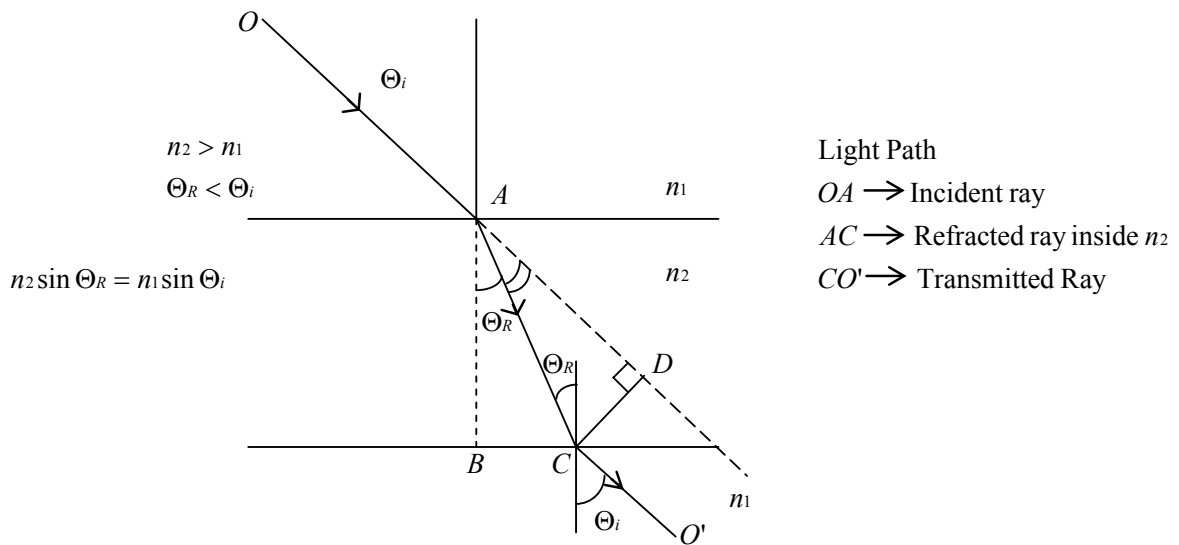

Notice that OC' is parallel to OA , so the light is shifted laterally by the amount CD .

In $\triangle ACD$, angle $CAD = (\Theta_i - \Theta_R)$

hence

$$\frac{CD}{AC} = \sin(\Theta_i - \Theta_R)$$

In $\triangle ABC$, $AB = t$ [thickness of slab]

$$\frac{t}{AC} = \cos \Theta_R$$

Hence

$$\begin{aligned} CD &= \frac{t}{\cos \Theta_R} [\sin \Theta_i \cos \Theta_R - \cos \Theta_i \sin \Theta_R] \\ &= t \sin \Theta_i \left[1 - \frac{\cos \Theta_i \sin \Theta_R}{\cos \Theta_R \sin \Theta_i} \right] \\ &= t \sin \Theta_i \left[1 - \frac{n_1 \cos \Theta_i}{n_2 \cos \Theta_R} \right] \end{aligned}$$

We will use this equation when we get to discussion of thin lenses.

.....Alcatel-Lucent 

www.alcatel-lucent.com/careers

What if you could build your future and create the future?

One generation's transformation is the next's status quo. In the near future, people may soon think it's strange that devices ever had to be "plugged in." To obtain that status, there needs to be "The Shift".



24.4 Total Internal Reflection

Now $n_2 < n_1$

Since $n_2 \sin \Theta_R = n_1 \sin \Theta_i$

$$\Theta_R > \Theta_i$$

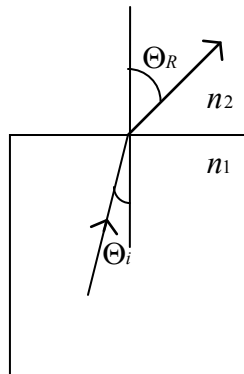

If you increase Θ_i , Θ_R increases until you get the critical case when refracted ray becomes **parallel** to the surface.

Now $\Theta_R = \frac{\pi}{2}$

$$n_2 \sin \frac{\pi}{2} = n_1 \sin \Theta_C$$

$$\sin \Theta_C = \frac{n_2}{n_1}$$

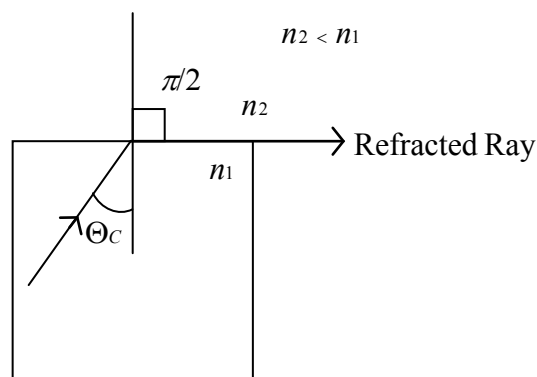

Example Glass $n_1 = 1.5$

Air $n_2 = 1$

$$\sin \Theta_C = \frac{1}{1.5}$$

$$\Theta_C \cong 4^\circ$$

If you make Θ_i larger than Θ_C **no** light can go out – Total Internal Reflection

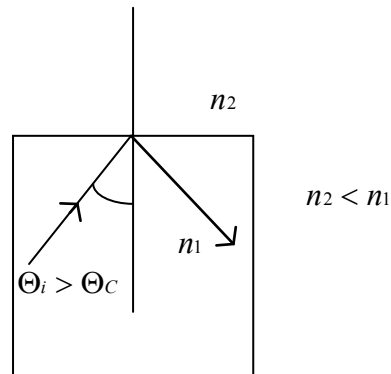

Join the best at
the Maastricht University
School of Business and
Economics!

Top master's programmes

- 33rd place Financial Times worldwide ranking: MSc International Business
- 1st place: MSc International Business
- 1st place: MSc Financial Economics
- 2nd place: MSc Management of Learning
- 2nd place: MSc Economics
- 2nd place: MSc Econometrics and Operations Research
- 2nd place: MSc Global Supply Chain Management and Change

Sources: Keuzegids Master ranking 2013; Elsevier 'Beste Studies' ranking 2012; Financial Times Global Masters in Management ranking 2012

Maastricht University is the best specialist university in the Netherlands (Elsevier)

Visit us and find out why we are the best!
Master's Open Day: 22 February 2014

www.mastersopenday.nl



Click on the ad to read more

24.5 Newton’s Experiments

He passed white light through a prism and found that it split into many colored rays. Technically we say light is dispersed into its component colors hence **Dispersion**.

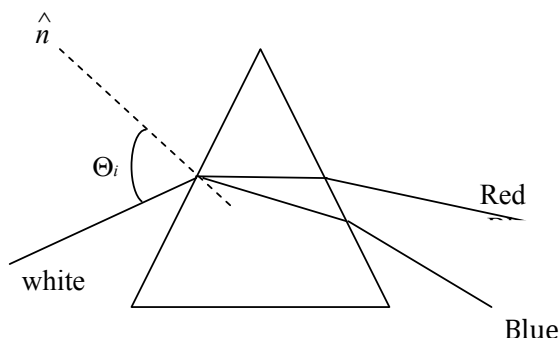

What did He learn?

1. In vacuum/air speed of light is same for all colors
2. White light is a composite of many colors
 V I B G Y O R
 Violet Indigo Blue Green Yellow Orange Red
 [Now we know that λ 's in vacuum go from 400nm to 700nm]
3. Speed of light in a medium is **NOT THE SAME FOR ALL COLORS**, which is why they split.
4. $\Theta_{Red} > \Theta_{Blue}$ but both satisfy Snell's Law

$$n_{Red} \sin \Theta_{Red} = n_{Blue} \sin \Theta_{Blue} = n_1 \sin \Theta_i$$

so $n_{Red} < n_{Blue}$

$$\frac{c}{V_{Red}} < \frac{c}{V_{Blue}}$$

$$V_{Red} > V_{Blue}$$

5. Now that we know the wavelengths we can plot refractive index as a function of λ and find

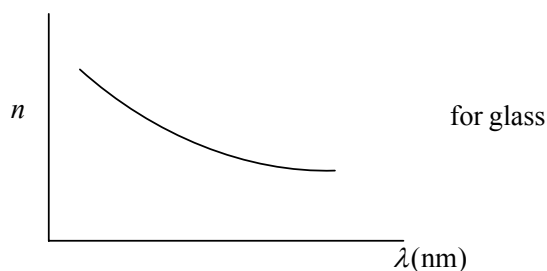

25 Formation Of Image – Mirrors

25.1 General Construct to locate image of a point object O using the laws of reflection and refraction to locate the path of light

Step 1: Take two incident rays I_1 and I_2 starting from O .

Step 2: Follow them through the optical system using

$$r = i \text{ for reflection}$$

and

$$n_2 \sin R = n_1 \sin i \text{ for refraction}$$

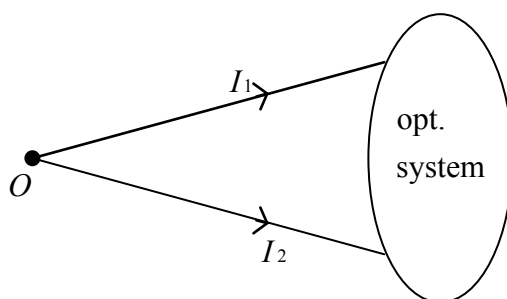

Step 3: Locate the two rays E_1 and E_2 that emerge from the optical system. Two cases arise.

Case I

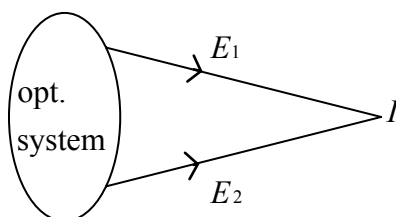

Point of intersection of E_1 and E_2 defines position of image I . Here, light actually goes through the point I so it is called a REAL IMAGE

Note: A real image can be projected on a screen.

Case II

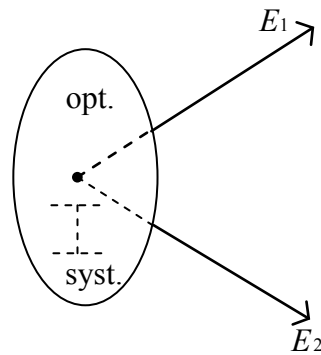

E_1 , E_2 are diverging so they will not intersect. You will have to extrapolate the E_1 , E_2 lines to locate the image as the point from which E_1 , E_2 “appear” to be coming. No light actually goes through so it is called a VIRTUAL IMAGE

Note A virtual image **cannot** be projected on a screen (your eye can see it)!

> **Apply now**

REDEFINE YOUR FUTURE
**AXA GLOBAL GRADUATE
 PROGRAM 2015**

redefining / standards 

agence.cdg © Photonistop

Some Definitions

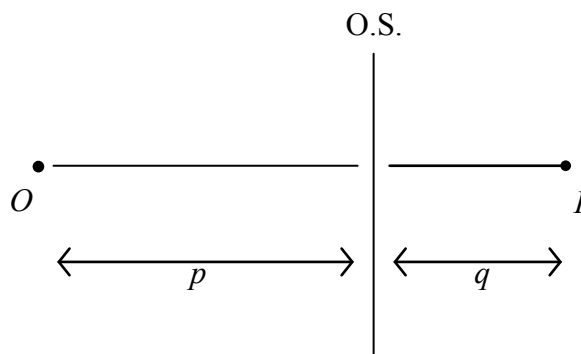

p = distance of object from opt. system (O.S.)

q = Distance of image from opt. system

Magnification $m = \frac{\text{size of image}}{\text{size of object}} = \frac{-q}{p}$

The minus sign on the right side ensures that for a single element O.S. all real images (q positive) are inverted (m negative) while all virtual images (q negative) are upright (m positive).

25.2 Mirror

A mirror is an optical system in which only reflections occur; so there is a light-side and a dark side. We use the “sign” convention that distances are “positive” on light side and “negative” on dark side.

25.3 Plane Mirror: Plane, silvered sheet of glass

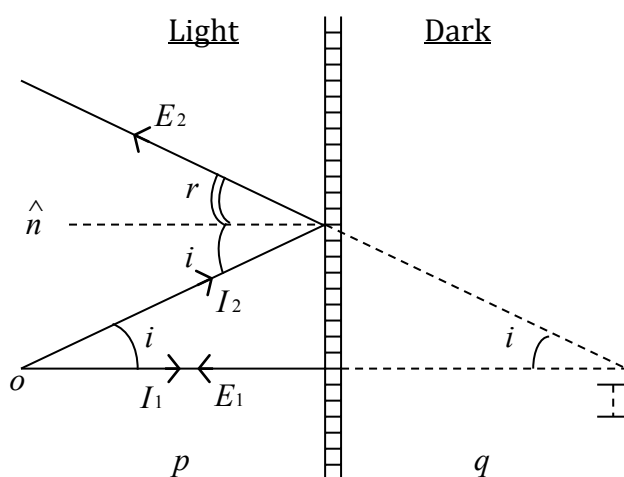

Two Rays:

$$I_1 \parallel \hat{n}$$

$$i = 0, \quad r = 0$$

$$E_1 \parallel \hat{n}$$

$$I_2: r = i$$

Locates E_2

E_1 and E_2 diverge. Locate image by extrapolation to.

q is negative

Image is virtual, clearly $|q| = p$

$$m = \frac{-q}{p} = +1$$

upright, virtual image is as far behind the mirror as the object is in front of it.

25.4 Spherical Mirrors: Mirror cut from a spherical shell of radius R .

Two Cases Arise

a) **CONCAVE CENTER OF SPHERE IN FRONT OF MIRROR.**

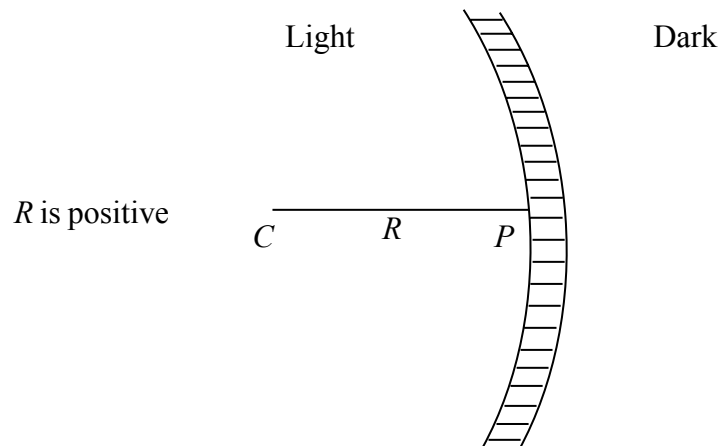

b) CONVEX CENTER OF SPHERE BEHIND MIRROR

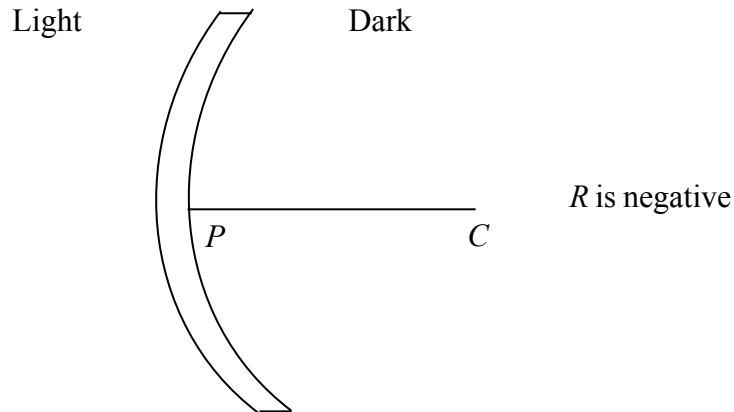

BI

Business
Strategic Marketing Management
International Business
Leadership & Organisational Psychology
Shipping Management
Financial Economics

BI NORWEGIAN BUSINESS SCHOOL

EFMD EQUIS ACCREDITED

Empowering People. Improving Business.

BI Norwegian Business School is one of Europe's largest business schools welcoming more than 20,000 students. Our programmes provide a stimulating and multi-cultural learning environment with an international outlook ultimately providing students with professional skills to meet the increasing needs of businesses.

BI offers four different two-year, full-time Master of Science (MSc) programmes that are taught entirely in English and have been designed to provide professional skills to meet the increasing need of businesses. The MSc programmes provide a stimulating and multi-cultural learning environment to give you the best platform to launch into your career.

- MSc in Business
- MSc in Financial Economics
- MSc in Strategic Marketing Management
- MSc in Leadership and Organisational Psychology

www.bi.edu/master



25.5 Images in Concave Mirror

We will consider only paraxial rays, that is all angles are taken to be very small so $\sin \theta \approx \tan \theta \approx \theta$.

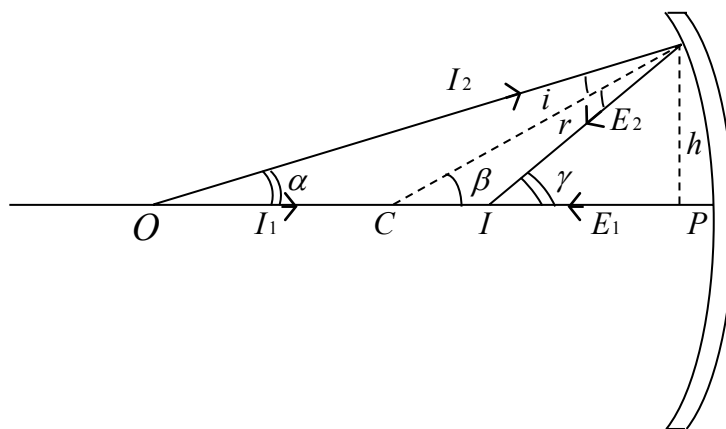

Same construct. I_1, I_2 start from 0, after reflection we get E_1, E_2 , intersection locates I .

Equations

$$\beta = \alpha + i$$

$$\gamma = \beta + r$$

$$i = r$$

Hence

$$\gamma = \beta + i = 2\beta - \alpha$$

Or

$$\gamma + \alpha = 2\beta$$

Angles are small, hence

$$\tan \gamma + \tan \alpha = 2 \tan \beta$$

$$\frac{h}{IP} + \frac{h}{OP} = \frac{2h}{CP}$$

Or

$$\frac{1}{p} + \frac{1}{q} = \frac{2}{R} \tag{1}$$

And combine with

$$m = \frac{-q}{p} \tag{2}$$

These two equations describe all possible images, and their sizes, formed by a concave mirror.

Further, a small object's image is located as follows: Rotate picture about the center (of curvature) C . The above calculations apply. Our assumption of paraxial rays requires that all objects are small.

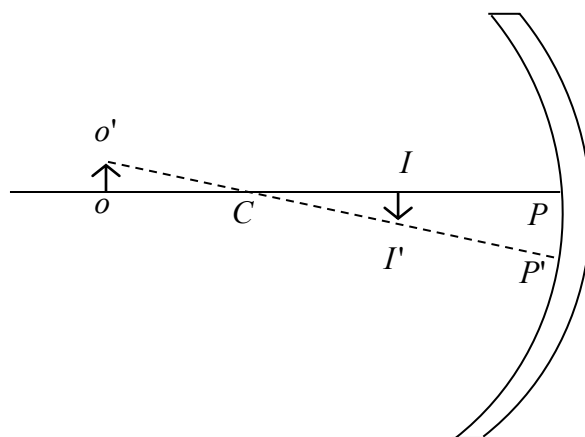

25.6 Special Cases [Eqs. (1) And (2)]

I $p \rightarrow \infty, q = \frac{R}{2}$

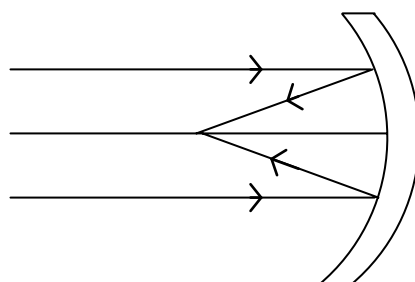

$p \rightarrow \infty$ implies that incident light is a parallel beam, and we learn that when a parallel beam falls on the mirror, after reflection it converges to a point. This defines the focus and the focal length

$$f = \frac{R}{2}$$

So $p \rightarrow \infty, q \rightarrow f, m \rightarrow 0$ Real Image

Concave mirror makes parallel light converge to a point hence
 Concave mirror = CONVERGENT MIRROR

NOTE NO REAL IMAGE CAN COME CLOSER TO THAN f !

II $p > R$ object lies beyond C.

$$\frac{1}{q} = \frac{2}{R} - \frac{1}{p} = \frac{2p - R}{pR}$$

$$\frac{p}{q} = \frac{2p - R}{R} = \frac{2R - R}{R} > (2 - 1) > 1$$

So $q < R$

$$m = \frac{-q}{p}, |m| < 1$$

Inverted, Real, Reduced Image

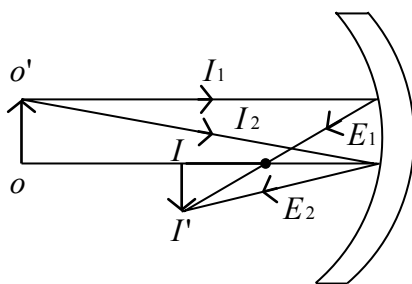

Need help with your dissertation?

Get in-depth feedback & advice from experts in your topic area. Find out what you can do to improve the quality of your dissertation!

Get Help Now



Go to www.helpmyassignment.co.uk for more info



III $p = R, q = R, m = -1$

Object lies at C. All light falls on mirror at $i = 0$, so it leaves at $r = 0$ and goes right back to C.

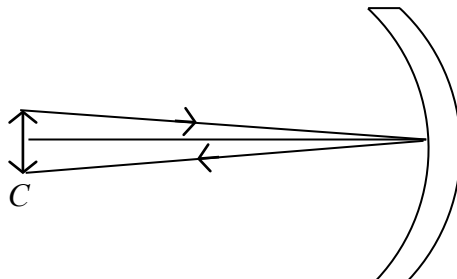

REAL, INVERTED IMAGE SAME SIZE AS OBJECT.

IV $p < R$: Object lies between C and F

$$\frac{p}{q} = \frac{2p - R}{R} = \frac{< 2R - R}{R} \ll 1$$

$$q > R, m = \frac{-q}{p}, |m| > 1$$

Inverted, Real, Enlarged Image

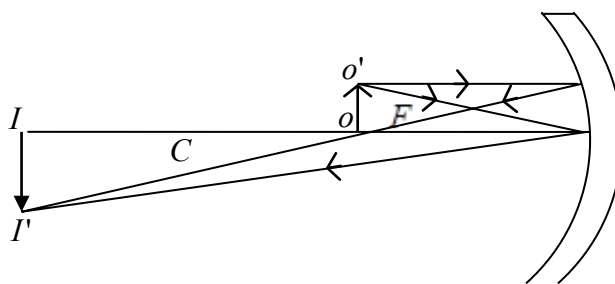

V $p = f$, object at F, $q \rightarrow \infty, m \rightarrow \infty$

Point source at F on reflection produces a parallel beam.

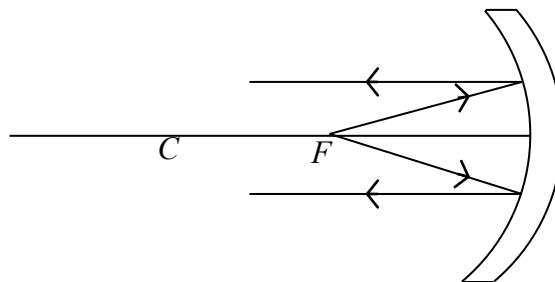

VI $p < f$, object closer to mirror than F ,

Since

$$\frac{1}{p} + \frac{1}{q} = \frac{1}{f}$$

This equation cannot be satisfied unless q becomes negative: IMAGE IS BEHIND MIRROR, ON THE DARK SIDE.

We get a VIRTUAL, ENLARGED IMAGE

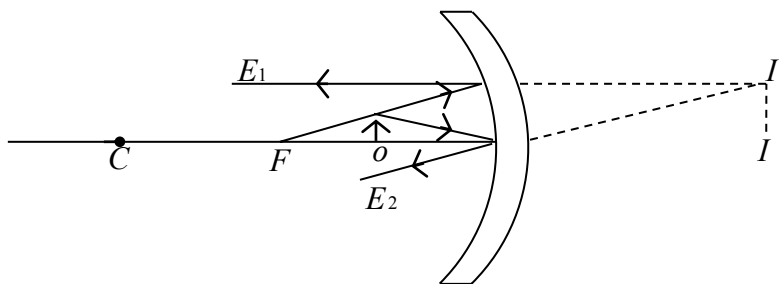

To Summarize: Start O far away, I at f (closest to mirror), bring O closer I moves away from mirror, gets bigger but remains inverted real, O at C , I at C , $m = -1$, O between C and F , I beyond C , enlarged, inverted, real, O at F , $I \rightarrow \infty$, Parallel light, O closer than F , I goes **BEHIND** mirror becomes virtual and upright.

25.7 Images in Convex Mirror

R is Negative

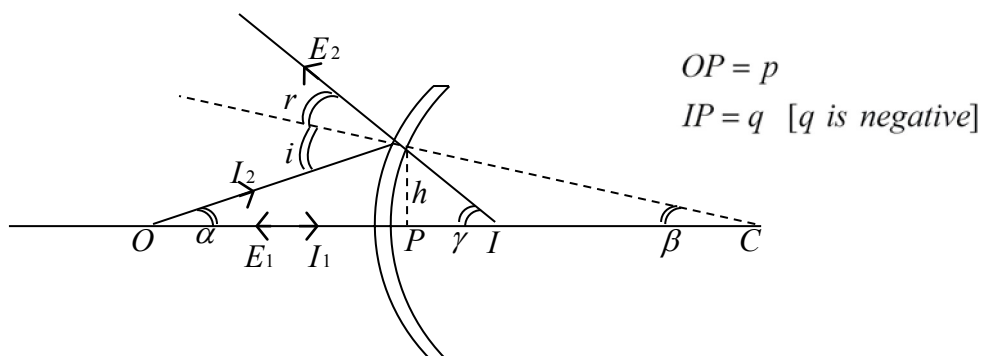

Equations

$$\gamma = i + \beta$$

$$i = \alpha + \beta$$

$$\gamma = \alpha + 2\beta$$

$$\alpha - \gamma = -2\beta$$

$$\tan \alpha - \tan \gamma = -2 \tan \beta$$

$$\frac{h}{p} - \frac{h}{q} = \frac{-2h}{R}$$

Or

$$\frac{1}{p} - \frac{1}{q} = \frac{-2}{R}$$

However, both q and R are negative so one should write

$$\frac{1}{p} + \frac{1}{q} = \frac{2}{R} \quad (3)$$

and supplement

$$m = \frac{-q}{p} \quad (4)$$

Brain power

By 2020, wind could provide one-tenth of our planet's electricity needs. Already today, SKF's innovative know-how is crucial to running a large proportion of the world's wind turbines.

Up to 25 % of the generating costs relate to maintenance. These can be reduced dramatically thanks to our systems for on-line condition monitoring and automatic lubrication. We help make it more economical to create cleaner, cheaper energy out of thin air.

By sharing our experience, expertise, and creativity, industries can boost performance beyond expectations. Therefore we need the best employees who can meet this challenge!

The Power of Knowledge Engineering

Plug into The Power of Knowledge Engineering.
Visit us at www.skf.com/knowledge

SKF

Special Cases

I $p \rightarrow \infty$, parallel light falls on mirror

$$q = \frac{R}{2} = f \text{ but } f \text{ is negative, } f \text{ is behind mirror on dark side}$$

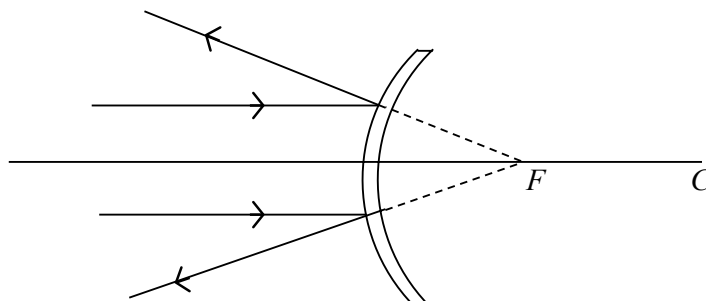

A parallel beam of light incident on a convex mirror, on reflection appears to start from F and becomes divergent.

Hence

CONVEX MIRROR \Rightarrow DIVERGENT MIRROR

II Since q is negative all images are VIRTUAL and upright

Also
$$\frac{1}{p} - \frac{1}{q} = \frac{-2}{R}$$

Or
$$\frac{1}{p} = \frac{1}{q} + \frac{2}{R} \quad \left[\frac{1}{q} > \frac{1}{p} \right]$$

So q is always less than p , and always less than f .

All images are virtual, upright and reduced.

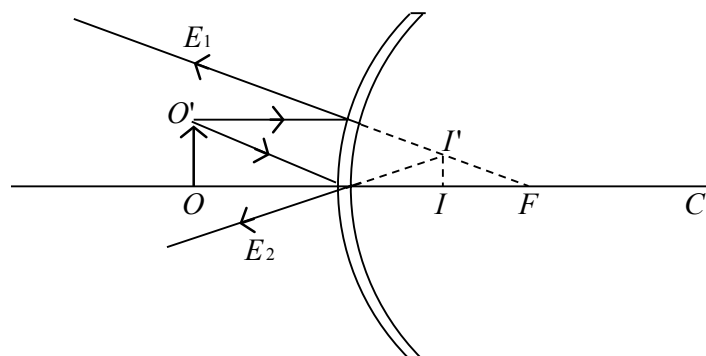

Right rear view mirror of automobiles!!

26 Formation Of Images – Refraction At A Single Surface

[SIGN CONVENTION: DISTANCES ALONG LIGHT PATH POSITIVE, AGAINST LIGHT PATH NEGATIVE]

26.1 Apparent Depth of Water in a Pool

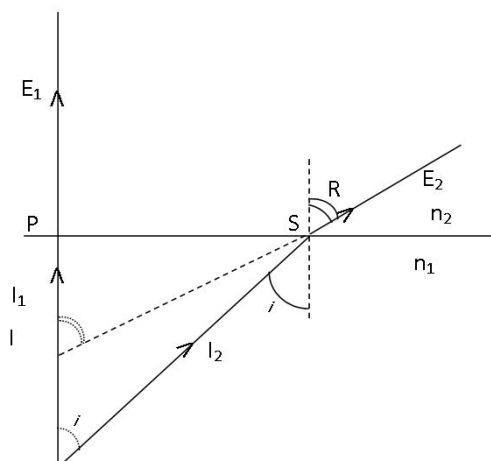

Suppose you are standing at the edge of a swimming pool and look straight down. If the actual depth of water is d meters what value do you perceive? We can solve this problem by putting a point object O at the bottom and locate its image formed by the water as the light refracts [optical system so all distances are measured from P] through its surface.

Look at the picture. Take two rays starting from O :

I_1 makes angle of incidence zero and gives rise to E_1

I_2 makes angle of incidence i and causes E_2 satisfying

$$n_2 \sin R = n_1 \sin i$$

Since you are looking straight down all angles are small.

The virtual Image at

I [q is negative] is located by intersection of E_1 and E_2 (extended backwards).

Next, from the picture we see

$$\tan R = \frac{SP}{IP} \tag{1}$$

$$\tan i = \frac{SP}{OP} \tag{2}$$

Divide Eq.(2) by Eq.(1)

$$\begin{aligned} \frac{IP}{OP} &= \frac{\tan i}{\tan R} \\ &\cong \frac{\sin i}{\sin R} && \left[\begin{array}{l} i < 1 \\ R < 1 \end{array} \right] \\ &= \frac{n_2}{n_1} \end{aligned}$$

Clearly $IP =$ apparent depth
 $OP =$ real depth

$$\frac{d_{app}}{d} = \frac{n_2}{n_1}$$

For water $n = 1.33$

For air $n = 1$

So
$$\frac{d_{app}}{d} = \frac{3}{4}$$

So if water is 80cm deep, to a person at the edge it will appear to be only 60cm [small children should be warned before they jump in and suddenly find that they are too short].

26.2 Single Convex Surface (positive r)

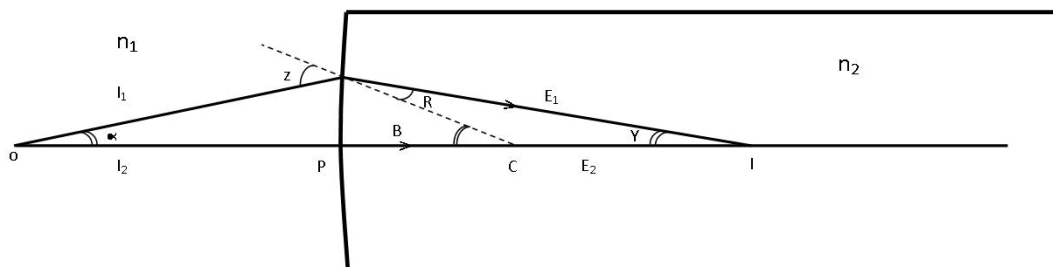

Here $OP =$ object distance (p)
 $IP =$ image distance (q)
 $CP =$ radius of curved surface (r)

And all angles are small

Equations are $n_1 \sin i = n_2 \sin R$

Or $n_1 i = n_2 R$ -(1)

$$\beta = \gamma + R \quad \text{-(2)}$$

$$i = \alpha + \beta \quad \text{-(3)}$$

From Eq.(2)
$$\beta = \gamma + \frac{n_1}{n_2} i$$

$$= \gamma + \frac{n_1}{n_2} (\beta + \alpha)$$

$$\beta \left[1 - \frac{n_1}{n_2} \right] = \gamma + \frac{n_1}{n_2} \alpha$$

Or
$$(n_2 - n_1) \beta = n_2 \gamma + n_1 \alpha$$

$$(n_2 - n_1) \tan \beta = n_2 \tan \gamma + n_1 \tan \alpha$$

$$\boxed{\frac{(n_2 - n_1)}{r} = \frac{n_2}{q} + \frac{n_1}{P}} \quad \text{(4)}$$

In order to access the magnification for a small object, imagine rotating OPI through a small angle you will get

$$\tan i = \frac{OO'}{p}$$

$$\tan R = \frac{II'}{q}$$

I' is negative!

$$m = \frac{I'}{O'} = \frac{-q \tan R}{p \tan i} = -\frac{n_2}{n_1} \frac{q}{p} \quad \text{(5)}$$

Special Cases

A p is such that $q \rightarrow \infty$, that is light becomes a parallel beam on entering the surface.

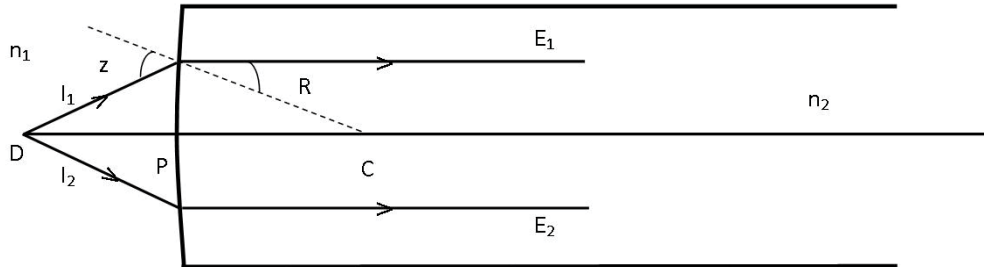

$$p = \frac{n_1 r}{n_2 - n_1} \tag{6}$$

What do you want to do?

No matter what you want out of your future career, an employer with a broad range of operations in a load of countries will always be the ticket. Working within the Volvo Group means more than 100,000 friends and colleagues in more than 185 countries all over the world. We offer graduates great career opportunities – check out the Career section at our web site www.volvogroup.com. We look forward to getting to know you!

VOLVO
 AB Volvo (publ)
www.volvogroup.com

VOLVO TRUCKS | RENAULT TRUCKS | MACK TRUCKS | VOLVO BUSES | VOLVO CONSTRUCTION EQUIPMENT | VOLVO PENTA | VOLVO AERO | VOLVO IT
 VOLVO FINANCIAL SERVICES | VOLVO 3P | VOLVO POWERTRAIN | VOLVO PARTS | VOLVO TECHNOLOGY | VOLVO LOGISTICS | BUSINESS AREA ASIA



- B** If p becomes even smaller than that given by Eq.(6), E_1 and E_2 will diverge the image will switch to the left of the surface and become virtual.

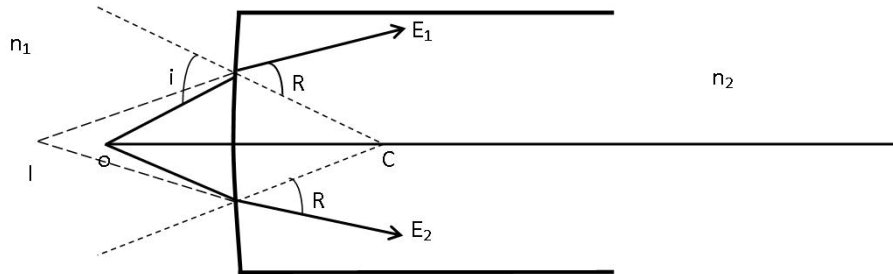

- C** Please note that if you set $r \rightarrow \infty$ in Eq.(4) you will recover the result of case I

$$\frac{q}{p} = -\frac{n_2}{n_1}$$

- D** If $p \rightarrow \infty$, INCIDENT BEAM is parallel

$$\frac{n_2}{f} = \frac{n_2 - n_1}{r}$$

where f is the focal length.

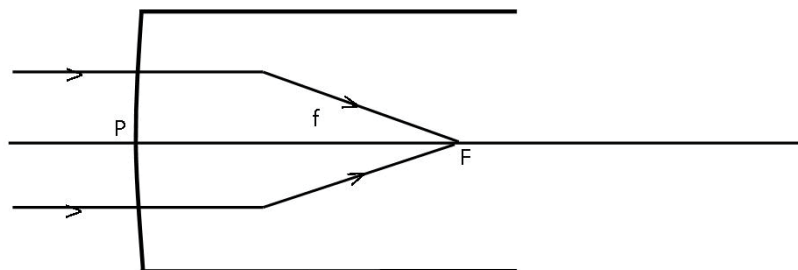

26.3 Single Concave Surface (negative r)

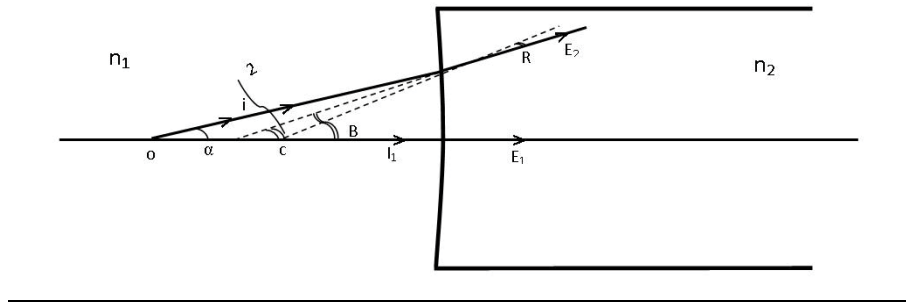

IMAGE IS ALWAYS VIRTUAL (q is negative)

Equations are $n_1 \sin i = n_2 \sin R$

Or $n_1 i = n_2 R$ -(1) Small Angles

$$\beta = \alpha + i \tag{2}$$

$$\beta = \gamma + R \tag{3}$$

$$\beta = \gamma + \frac{n_1}{n_2} i = \gamma + \frac{n_1}{n_2} (\beta - \alpha)$$

$$\tan \beta = \tan \gamma + \frac{n_1}{n_2} (\tan \beta - \tan \alpha)$$

$$\frac{1}{r} \left[1 - \frac{n_1}{n_2} \right] = \frac{1}{q} - \frac{n_1}{p}$$

$$\frac{n_1}{p} - \frac{n_2}{q} = -\frac{1}{r} (n_2 - n_1)$$

But q and r are negative; Hence again

$$\boxed{\frac{n_2}{q} + \frac{n_1}{P} = \frac{n_2 - n_1}{r}}$$

r negative

q negative

Special Case $p \rightarrow \infty$ $q \rightarrow f$

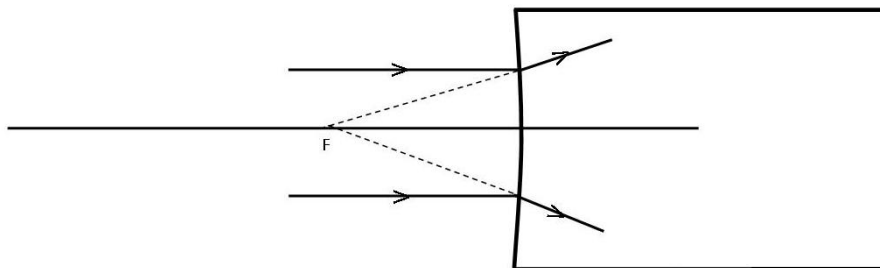

f is negative

$$\frac{n_2}{f} = \frac{n_2 - n_1}{r}$$

gaiTeye
Challenge the way we run

EXPERIENCE THE POWER OF FULL ENGAGEMENT...

**RUN FASTER.
RUN LONGER..
RUN EASIER...**

**READ MORE & PRE-ORDER TODAY
WWW.GAITEYE.COM**



27 Formation Of Images – Thin Lenses

This case also involves refraction so we have the same sign convention:

distances measured along the path of light: positive
 distances measured against the path of light: negative

27.1 Lens

Consists of a transparent material which has two curved surfaces. We will deal with surfaces which are spherical so only two radii are required.

Lens Makers' Formula Focal length f is given by

$$\frac{1}{f} = (n - 1) \left[\frac{1}{R_F} - \frac{1}{R_B} \right]$$

Here n = refractive index of material which is placed in air ($n = 1$)

R_F = radius of front surface (facing the incident light)

R_B = radius of back surface

Thin Lenses the thickness of the lens is much smaller the R_F and R_B .

Two Cases Arise

I Convergent Lens

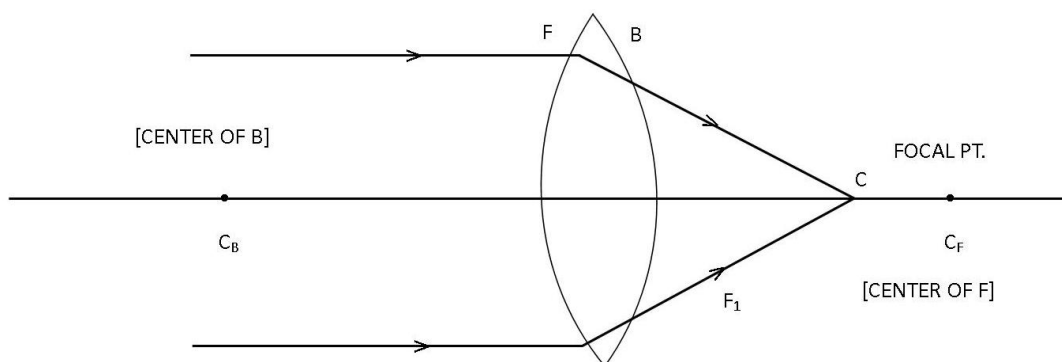

In this case R_F is positive

R_B is negative

$$\frac{1}{f} = (n - 1) \left[\frac{1}{R_F} - \frac{1}{R_B} \right] \text{ is positive}$$

Because f is positive focal point is to the right of the lens hence parallel light falling on the lens will be made to converge to a point, as shown above.

Light actually goes through the focal point, you can project it on a screen.

II Divergent Lens

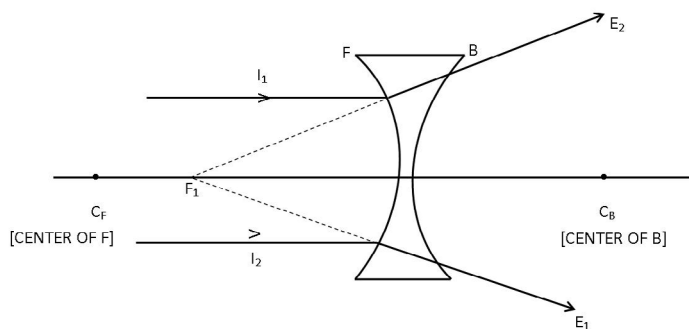

Here R_F is negative

R_B is positive

$$\frac{1}{f} = (n - 1) \left[\frac{1}{R_F} - \frac{1}{R_B} \right] \text{ is negative}$$

Because f is negative focal point is to the left of the lens hence parallel light falling on the lens will appear to diverge from a point, as shown above.

Notice, no light actually goes through this focal point; it is a VIRTUAL point (negative distance). You CANNOT project it on a screen.

27.2 Image Formation

Convergent Lens

$OC = p$ object distance

$IC = q$ image distance

$cf =$ focal length

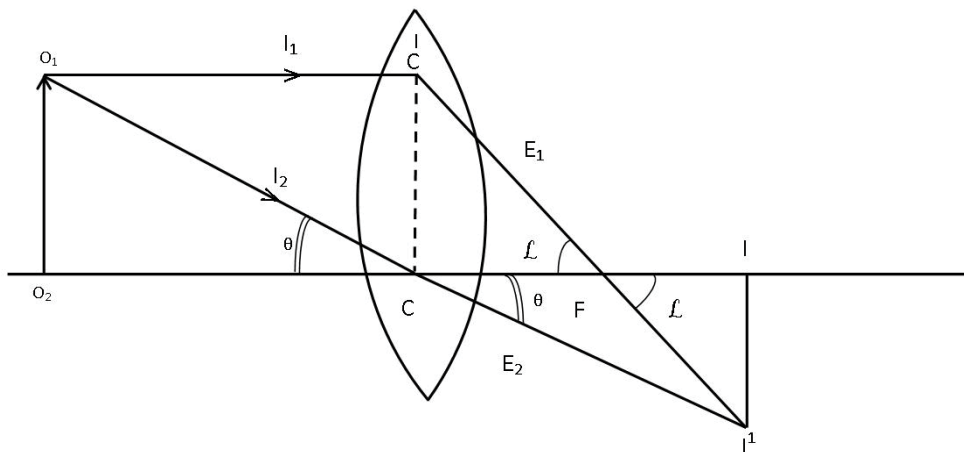

Note: All angles are supposed to be small and thickness is small that is why lateral shift is negligible and the ray through C goes straight.

This e-book
is made with
SetaPDF



SETASIGN



PDF components for PHP developers

www.setasign.com



First look at magnification $m = \frac{-q}{p}$

$$\frac{II'}{OO'} = \left| \frac{q}{p} \right|$$

and indeed I' is inverted, m is negative!

Next from angles α

$$\frac{II'}{IF} = \frac{CC'}{CF}$$

$$\frac{II'}{CC'} = \frac{IF}{CF} = \frac{q-f}{f}$$

But $CC' = OO'$

So

$$\frac{II'}{OO'} = \frac{q-f}{f} = \frac{q}{p}$$

$$\frac{q}{f} - 1 = \frac{q}{p}$$

$$\frac{q}{f} = 1 + \frac{q}{p}$$

With

$$\boxed{\begin{array}{l} \frac{1}{p} + \frac{1}{q} = \frac{1}{f} \\ m = \frac{-q}{p} \end{array}}$$

and these two equations describe all possible images formed by the lens. We can recall all the cases which arose in convergent mirror case –

- | | | | |
|------|------------------------|-----------------------------|---------------------------------|
| i) | $p \rightarrow \infty$ | $q \rightarrow f$ | $m = 0$ |
| ii) | $p > 2f$ | $q < 2f$ | m negative and less than 1 |
| iii) | $p = 2f$ | $p = 2f$ | m negative and equal to 1 |
| iv) | $p < 2f$ | $p > 2f$ | m negative and greater than 1 |
| v) | $p < f$ | q negative, virtual image | m positive |

27.3 Divergent Lens

$$OC = p$$

$$IC = q \text{ [negative]}$$

$$FC = f \text{ [negative]}$$

$$CC' = OO'$$

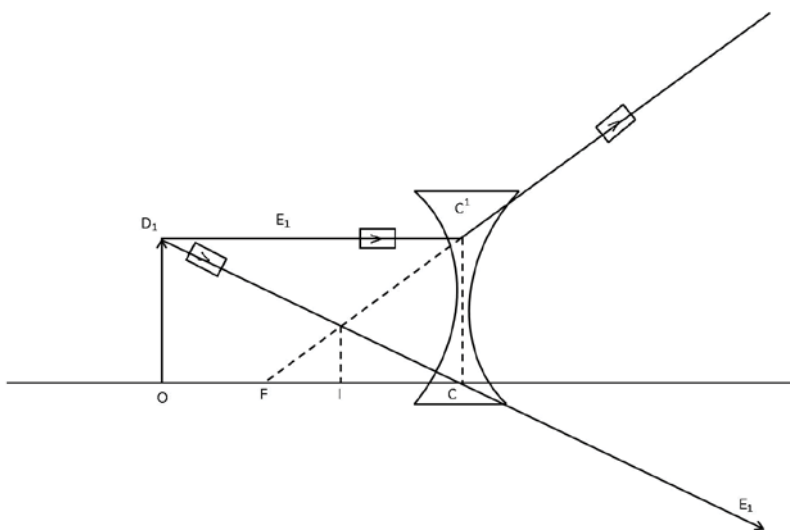

In this case **ALL IMAGES ARE VIRTUAL UPRIGHT** and **REDUCED** ($m < 1$). [like in convex mirror]

Now

$$\frac{CC'}{II'} = \frac{f}{f - q} = \frac{p}{q}$$

So $\frac{f - q}{f} = \frac{q}{p}$

$$1 - \frac{q}{f} = \frac{q}{p}$$

$$\frac{q}{p} - 1 = \frac{-q}{p}$$

$$\frac{1}{p} - \frac{1}{q} = -\frac{1}{f}$$

But both f and q are negative, hence again

$$\frac{1}{p} + \frac{1}{q} = \frac{1}{f} \quad \text{with} \quad m = \frac{-q}{p}$$

28 Wave Optics: Interference And Diffraction

28.1 Radiation: Electromagnetic wave

Light: Transverse E.M. Wave

$$\lambda_0 : 400nm < \lambda_0 < 800nm[\text{in vacuum}]$$

$$f : 4 \times 10^{14} < f < 8 \times 10^{14} \text{ Hz}$$

$$\text{Speed } c = \frac{1}{\sqrt{\mu_0 \epsilon_0}} = 3 \times 10^8 \text{ m/sec in vacuum}$$

$$V = \frac{c}{n} \text{ in medium, } n > 1$$

$$\lambda_n = \frac{\lambda_0}{n}$$



www.sylvania.com

We do not reinvent the wheel we reinvent light.

Fascinating lighting offers an infinite spectrum of possibilities: Innovative technologies and new markets provide both opportunities and challenges. An environment in which your expertise is in high demand. Enjoy the supportive working atmosphere within our global group and benefit from international career paths. Implement sustainable ideas in close cooperation with other specialists and contribute to influencing our future. Come and join us in reinventing light every day.

Light is OSRAM

OSRAM SYLVANIA 



Click on the ad to read more

We can represent a light wave travelling along x as an \underline{E} -wave

$$E = E_m \sin(kx - \omega t + \Phi), \quad \underline{E}_m \perp \hat{x}$$

$$k = \frac{2\pi}{\lambda}$$

$$\omega = \frac{2\pi}{f}$$

$$E_m = \text{amplitude}, \quad \Phi = \text{phase}$$

28.2 Superposition:

Recall that when more than one wave is present at the same point at the same time, the net effect is obtained by making an algebraic sum.

Let us consider two light waves

$$E_1 = E_m \sin(kx - \omega t + \Phi_1)$$

$$E_2 = E_m \sin(kx - \omega t + \Phi_2)$$

That is, they have the same wavelength and the same frequency but the phases are different.

We begin by noting that emission of light involves an electron jumping from one energy level to another in its parent atom and each jump lets out a wave train about 3m long. Since there are “zillions” of atoms we have an enormous number of wave trains with arbitrary phases so a light wave from a typical source has a phase which varies randomly in time.

If you superpose E_1 and E_2 you will get

$$\begin{aligned} E &= E_1 + E_2 \\ &= 2E_m \cos\left(\frac{\Phi_1 - \Phi_2}{2}\right) \sin\left(kx - \omega t + \frac{\Phi_1 + \Phi_2}{2}\right) \end{aligned}$$

That is, a wave whose amplitude is

$$\text{Amp} = 2E_m \cos\left(\frac{\Phi_1 - \Phi_2}{2}\right)$$

$$\text{Intensity} \quad I \propto (\text{Amp})^2$$

$$\text{So} \quad I \propto 4E_m^2 \cos^2\left(\frac{\Phi_1 - \Phi_2}{2}\right) \quad \left[\text{the factors } \frac{1}{2} \epsilon_0 c \text{ are left out}\right]$$

Two totally different situations arise.

Case I The sources of E_1 and E_2 are Incoherent

That is, $(\Phi_1 - \Phi_2)$ is a random function of time. If so, I is also a random function of time. The observed value will be a time average:

$$\langle I \rangle \propto 4E_m^2 \langle \cos^2\left(\frac{\Phi_1 - \Phi_2}{2}\right) \rangle$$

$$\text{But } \langle \cos^2\left(\frac{\Phi_1 - \Phi_2}{2}\right) \rangle = \frac{1}{2}$$

$$\text{So } \langle I \rangle \propto 2E_m^2$$

Hence, for two incoherent sources the total intensity is just the sum of the two intensities. Two light bulbs just increase brightness.

Case II The sources of E_1 and E_2 are COHERENT

That is, the waves E_1 and E_2 are specially prepared in such a way that $(\Phi_1 - \Phi_2)$ is a fixed quantity (independent of time for our discussion) at any given location. [This is the case we discussed for sound waves a while ago]. So how do we get two coherent light sources. We discuss two examples.

28.3 Double Slit Interference

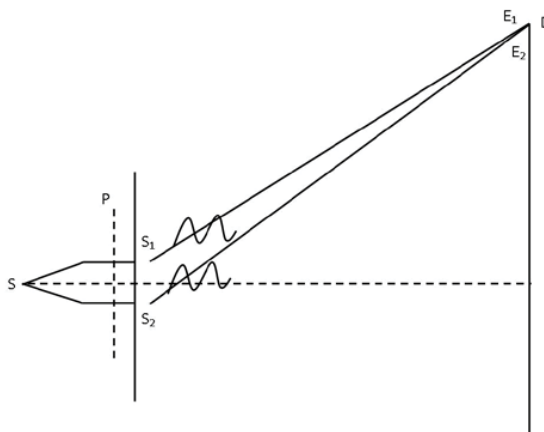

S is a point source of light located at the focal point of a convergent lens. After passing through the lens the light becomes a parallel beam. The corresponding wave front is a plane P travelling toward the right. Now, place a plate with two small slits each of width w separated by d . Assume $w \ll d$. The waves which emerge from S_1 and S_2 are both derived from the **SAME** wave front so at S_1 and S_2 they have same phase (say zero). By the time they arrive at the screen their phases would have changed (see detail below) but $(\Phi_1 - \Phi_2)$ does NOT vary with time. We have two coherent sources producing E_1 and E_2 at the screen.

In modern experiments the source is a laser which produces a parallel beam. S_1 and S_2 are slits in a plate and you use a screen to view the interference pattern

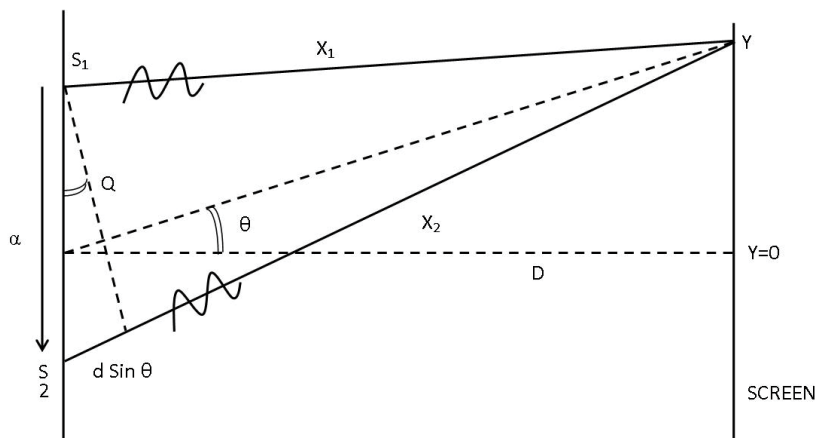

Separation between S_1 and $S_2 = d$

Distance to screen = D

Position of detector = y [$y = 0$ at mid-point of sources]

x_1 = distance travelled by E_1

x_2 = distance travelled by E_2

[Note: All angles are small so obliquity effects are negligible.]



Discover the truth at www.deloitte.ca/careers

Deloitte.

© Deloitte & Touche LLP and affiliated entities.



At y : Phase of E_1 , $\Phi_1 = \frac{2\pi}{\lambda} x_1$

Phase of E_2 , $\Phi_2 = \frac{2\pi}{\lambda} x_2$

$$\left(\frac{\Phi_1 - \Phi_2}{2} \right) = \frac{2\pi}{\lambda} \left(\frac{x_1 - x_2}{2} \right)$$

If $(x_1 - x_2) = M\lambda$, $M = 0, \pm 1, \pm 2 \dots$

$$\frac{\Phi_1 - \Phi_2}{2} = M\pi$$

$$\cos^2 \left(\frac{\Phi_1 - \Phi_2}{2} \right) = 1$$

So at such points I will be **maximum** Condition for Maxima

$$(x_1 - x_2) = M\lambda, \quad M = 0, \pm 1, \pm 2 \dots$$

However, if $(x_1 - x_2) = \left(m + \frac{1}{2} \right) \lambda$, $m = 0, \pm 1, \pm 2 \dots$

$$\frac{\Phi_1 - \Phi_2}{2} = \left(m + \frac{1}{2} \right) \pi$$

$$\cos^2 \left(m + \frac{1}{2} \right) \pi \equiv 0 \quad \underline{I = 0}$$

Condition for Minima

$$(x_1 - x_2) = \left(m + \frac{1}{2} \right) \lambda$$

From the picture you can see that

$$(x_1 - x_2) = d \sin \Theta$$

So $d \sin \Theta_M = M\lambda$ [Maxima]

$$d \sin \Theta_m = \left(m + \frac{1}{2} \right) \lambda$$
 [Minima]

And of course, all angles are small, $\frac{\lambda}{d} < 1$.

Consider the y -coordinate of the M^{th} maximum.

$$\begin{aligned}\frac{y_M}{D} &= \tan \Theta_M = \sin \Theta_M \\ &= \frac{M\lambda}{d}\end{aligned}$$

Similarly, its next neighbor has

$$\frac{y_{M+1}}{D} = \frac{(M+1)\lambda}{d}$$

So
$$y_{M+1} - y_M = \frac{D\lambda}{d}$$

So for two slit interference

$$I = \frac{1}{2} \epsilon_0 c 4 E_m^2 \cos^2 \left(\frac{\Phi_1 - \Phi_2}{2} \right)$$

and consists of equally spaced $\left(\frac{D\lambda}{d} \right)$ equal intensity $\left(\frac{1}{2} \epsilon_0 c 4 E_m^2 \right)$ fringes.

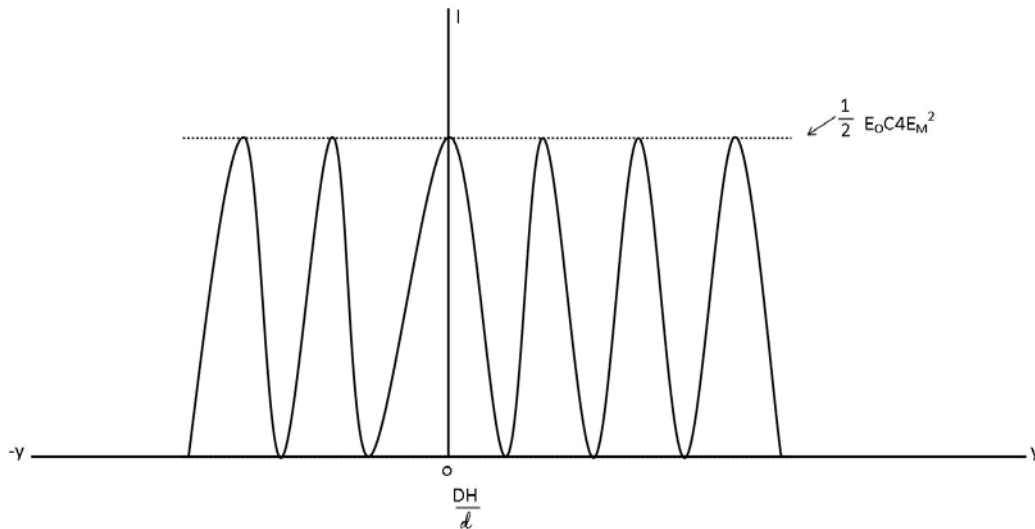

Space Average intensity on screen

$$\langle I \rangle = \frac{1}{2} \epsilon_0 c 2 E_m^2 \quad \left[\langle \cos^2 \Theta \rangle = \frac{1}{2} \right]$$

28.4 Thin Film Interference

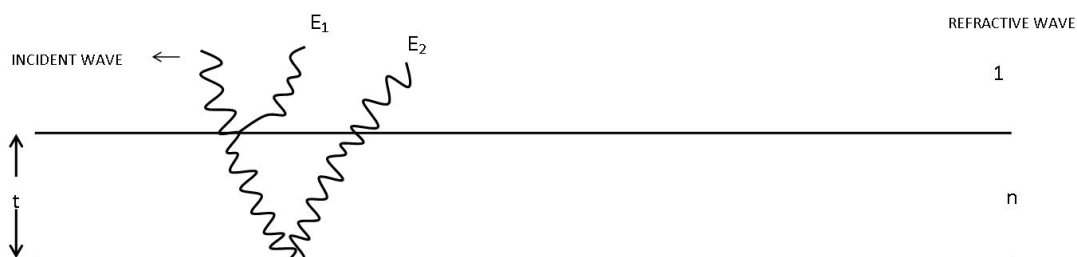

A thin film of thickness t and refractive index n is deposited on a block of refractive index n' . A light wave is incident on the top surface at an angle of incidence of a fraction of a degree ($i \approx 0, r \approx 0, R \approx 0$). On reflection from the top surface we get one wave (designated E_1), part of the light enters the film producing the second wave (E_2). Both E_1 and E_2 are derived from the same incident wave so their phase difference is a fixed quantity depending on the thickness of t . E_1 and E_2 are coherent.

The condition for maxima and minima are of course,

$$(x_1 - x_2) = M\lambda, \quad M = 0, \pm 1, \pm 2...$$

Or
$$(x_1 - x_2) = \left(m + \frac{1}{2}\right)\lambda, \quad m = 0, \pm 1, \pm 2...$$

However, now we must also consider what happens to the phase when a wave undergoes reflection.

SIMPLY CLEVER

ŠKODA



We will turn your CV into an opportunity of a lifetime

Do you like cars? Would you like to be a part of a successful brand? We will appreciate and reward both your enthusiasm and talent. Send us your CV. You will be surprised where it can take you.

Send us your CV on www.employerforlife.com



Click on the ad to read more

Recall what we learnt while studying reflection of waves on stretched strings except now we cast it in terms of E-wave.

Incident wave

$$E_i = E_{mi} \sin(kx - \omega t)$$

Reflected Wave

$$E_r = E_{mr} \sin(kx + \omega t)$$

and
$$\frac{E_{mr}}{E_{mi}} = \frac{V_1 - V_2}{V_1 + V_2}$$

Let us compare waves at $x = 0$ where the reflection occurs.

$$E_i = E_{mi} \sin(-\omega t) = E_{mi} \sin(\omega t + \pi)$$

$$E_r = E_{mr} \sin \omega t$$

Two Cases Arise

i) $V_1 < V_2$ $[n_1 > n_2]$

$$\frac{E_{mr}}{E_{mi}} \text{ is negative}$$

$$E_i = E_{mi} \sin(\omega t + \pi)$$

$$E_r = E_{mr} \sin(\omega t + \pi)$$

No Phase Change.

ii) $V_1 > V_2$ $[n_1 < n_2]$

$$\frac{E_{mr}}{E_{mi}} \text{ is positive}$$

$$E_i = E_{mi} \sin(\omega t + \pi)$$

$$E_r = E_{mr} \sin \omega t$$

phase change of π on reflection.

Now let us consider interference between E_1 and E_2 .

First, extra distance travelled by E_2 is $2t$ but refractive index is n so wavelength in medium is $\frac{\lambda_0}{n}$ where λ_0 is wavelength in air.

Next, if $n' > n$ [$v' < v$] there is π phase change for both E_1 and E_2 so condition for maximum is

$$2nt = M\lambda_0 \quad M = 0, \pm 1, \pm 2 \dots$$

However if $n' < n$ [$v' > v$]. Only E_1 has a phase change while E_2 has none so condition for maximum becomes

$$\left(2nt - \frac{\lambda_0}{2} \right) = M\lambda_0$$

Notice a phase change of π is like a path difference of $\frac{\lambda_0}{2}$.

Colors of thin films of oil on water, or the surface of soap bubbles, arise because of thin film interference. Non-reflecting glass is produced by depositing a thin layer of transparent material and ensuring destructive interference for $\lambda_0 \sim 600nm$ [Green Light].

28.5 Multiple Source Interference – All Sources Coherent

of sources Amplitudes

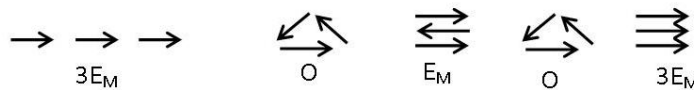
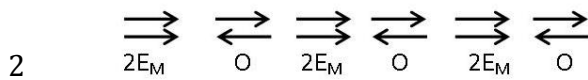

3

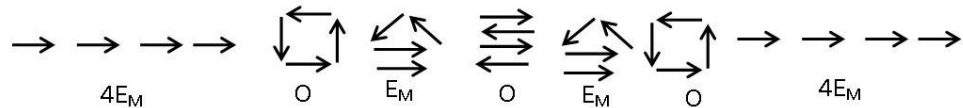

29 Diffraction – Single Slit

Diffraction arises because of superposition of a very large number of waves. Experimentally, it manifests itself by the spreading of a wave when it passes through an opening whose size is comparable to the wavelength that is why sound exhibits diffraction when it goes through doors and windows while diffraction of light is observable only when light goes through narrow slits. Here we discuss only Fraunhofer Diffraction: Parallel Light.

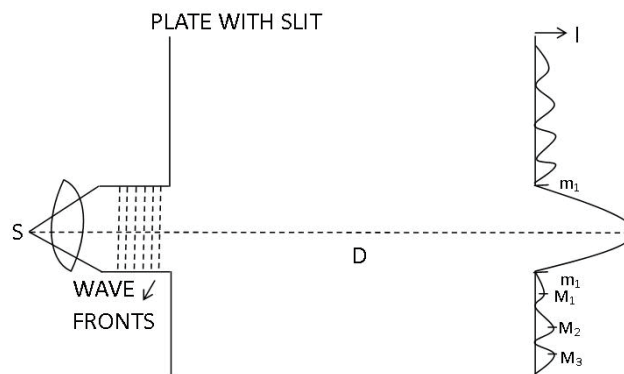

I joined MITAS because
I wanted **real responsibility**

The Graduate Programme
for Engineers and Geoscientists
www.discovermitas.com



Month 16

I was a construction
supervisor in
the North Sea
advising and
helping foremen
solve problems

Real work
International opportunities
Three work placements



 **MAERSK**

EXPT: S is a point source of light of wavelength λ . It is placed at the focal point of a lens so after passing through the lens we get a parallel beam which is pictured as a plane wave front travelling to the right. We place a plate with a narrow slit of width w and let the light fall on a screen a distance D away. What you observe is a series of maxima M_0, M_1, M_2, \dots where the central one (M_0) is brightest and the intensity reduces rapidly as you go from $M_0 \rightarrow M_1 \rightarrow M_2 \rightarrow M_3 \rightarrow \dots$. Alternately m_1, m_2, m_3 locate the “dark” spots in between.

Alternately, one can use a laser as a light source as that produces a parallel beam and hence plane wave fronts.

Our challenge is to construct a simple model which will allow us to understand the observations. We begin by recalling Huygen’s Construct that every point of a wave /u front is a source. Thus, it is quite reasonable to claim that the part of the wave front exposed by the slit gives rise to a large number (say $N \gg 1$) of waves all of which start in step (in phase) from the wave front. So now we must try to explain how N waves arriving at the screen conspire to produce the intensity pattern observed by us.

CENTRAL MAXIMUM (M_0): All of the waves arrive at the screen in phase because maximum path difference is $\frac{w^2}{4D}$ which is much smaller than λ for $w = 10^{-4} m$ and $D = 1m$. So if each one contributes the amplitude E_m , total amplitude at M_0 would be given by vector addition.

$$\begin{matrix} \rightarrow & \rightarrow & \rightarrow & \rightarrow & \dots & \rightarrow \\ E_m & & & & & \end{matrix} = NE_m$$

So intensity of M_0

$$I_0 \propto N^2 E_m^2 \quad \text{[Again constants } \frac{1}{2} \epsilon_0 C \text{ omitted]}$$

FIRST MINIMUM (m_1): Here total intensity is zero. So we want all N waves to add together to produce a zero:

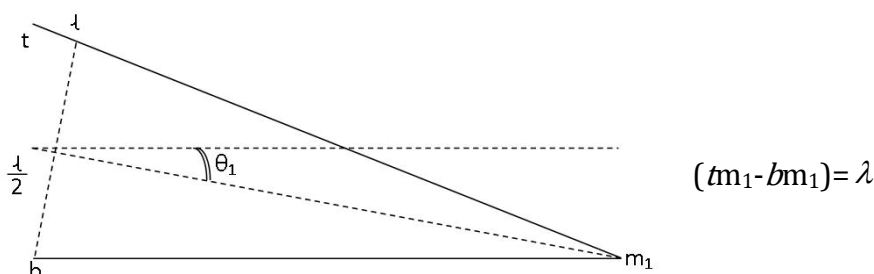

This will happen if the path difference between the wave coming from t and that coming from b is exactly λ . Then the slit can be split into two parts: for every wave coming from the lower half there will be one coming from the upper half which is $\frac{\lambda}{2}$ behind and hence they cancel each other.

The angle θ_1 which locates m_1 is therefore given by

$$\sin \theta_1 = \lambda/w$$

Thus the central maximum, which is bounded by m_1 and m'_1 will have a width of $2\theta_1$. The smaller the w the larger the spread due to diffraction.

In terms of the E_m vectors θ_1 happens because:

The string of length NE_m has been wound $\sum E_m = 0$ around so it closes on itself.

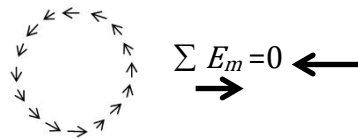

FIRST MAXIMUM M_1

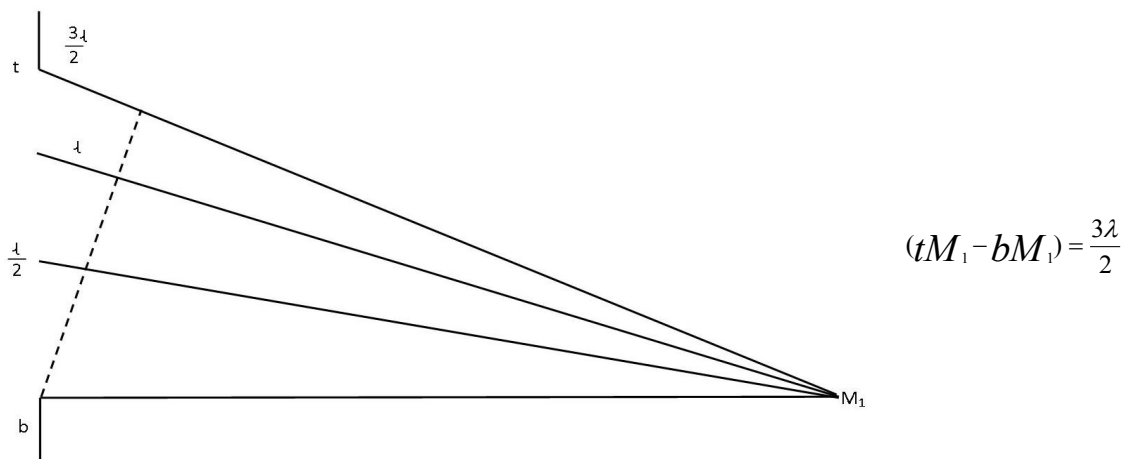

Now the waves arrange themselves so that the path difference between the wave from t and that from b is $\frac{3\lambda}{2}$. Effectively the slit splits into 3 equal parts, two of which cancel one another so that only $\frac{1}{3}rd$ of the sources contribute $\frac{1}{3}rd$ to the amplitude at M_1 .

To calculate the amplitude at M_1 let us wind our string of length NE_m some more until it looks like.

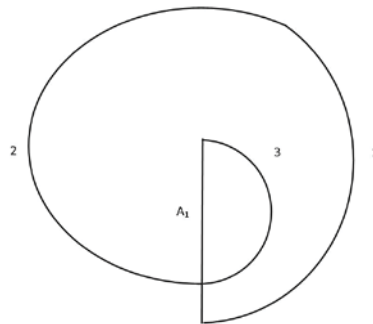

The sum of all the vectors is A_1 and $\frac{3\pi}{2} A_1 = N E_m$

Hence amplitude at M_1

$$A_1 = \frac{2}{3\pi} N E_m$$

$$I_1 \propto \frac{4}{9\pi^2} N^2 E_m^2$$

$$I_1/I_0 = \frac{4}{9\pi^2}$$

M_1 is barely $1/20^{\text{th}}$ as intense as M_0 .

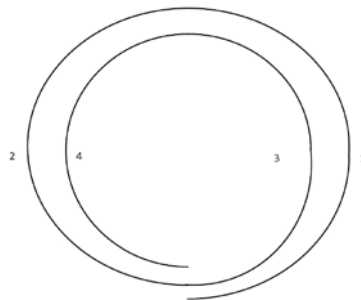

SECOND MINIMUM (m_2): This requires us to wind the string even more so it looks like

$$\sum E_m = 0$$

We need $t m_2 - b m_2 = 2\lambda$

The slit splits into 4 equal parts each quarter cancels its neighbor.

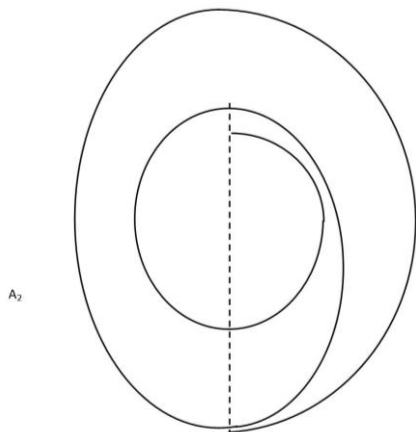

SECOND MAXIMUM M_2 :
Continue winding further

$$\frac{5\pi}{2} A_2 = NE_m$$

$$A_2 = \frac{2}{5\pi} NE_m$$

$$\frac{I_2}{I_0} = \frac{4}{25\pi^2}$$

I_2 is nearly 62 times smaller than I_0 . Subsequent minima/maxima follow from the above discussion.

29.1 Two-Slit Expt: Interference + Diffraction

In discussing the two slit interference previously we assumed that $w \ll d$ so that the central maximum for diffraction became much broader than the width of the interference fringes and that allowed us to discuss the interference effect alone. In practice w and d can be quite comparable and what you observe is a diffraction-cum- interference pattern: diffraction maxima with interference fringes inside them. Shown below are intensity patterns for the case $d = 3w$

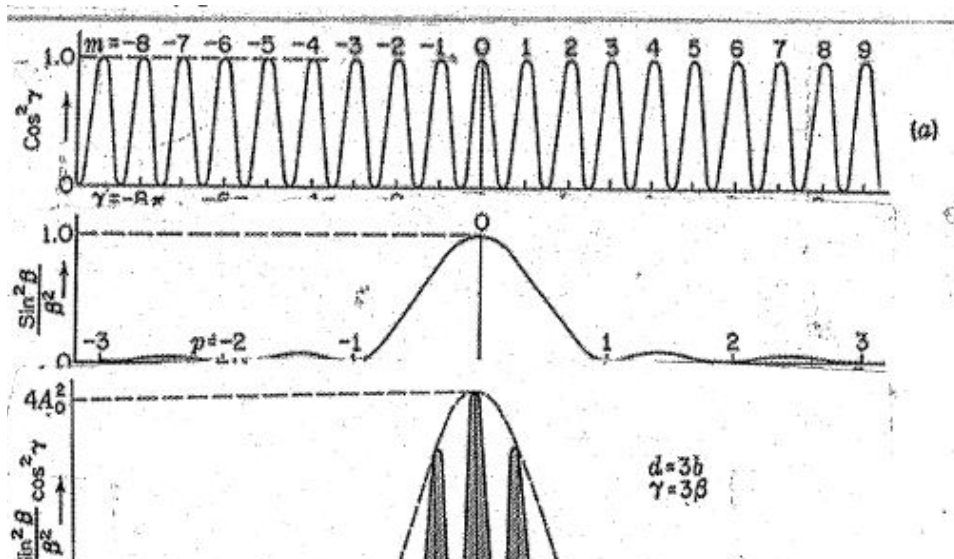

30 Problems in Elementary Physics

30.1 Problems: Week 1

- 1-1. You drop a ball from a height of $y = 1\text{m}$, on bouncing from the floor, if the collision is totally elastic, it will again rise to 1m and in principle this up and down excursion can last forever. Do you think this is a case of harmonic vibration? Justify your answer.
- 1-2. For the Earth-Mass system the potential energy of the mass M at a height h above the Earth is $P_g = Mgh$ ($h \ll R_E$) while for a spring of spring constant k the potential energy for change of length x is $P_{sp} = \frac{1}{2} kx^2$. So which is larger P_g for $M = 0.1\text{kg}$ and $h = 1\text{m}$ or P_{sp} for $k = 1.9 \times 10^4\text{N/m}$ and $x = 0.01\text{m}$? Justify your answer. [$R_E = \text{radius of Earth}$, $g = 9.8\text{m/sec}^2$]
- 1-3. $P_g = Mgh$ is good only if $h \ll R_E$, otherwise $P_G = \frac{-GM_E M}{r}$, where $M_E = \text{mass of Earth} = 6 \times 10^{24}\text{kg}$, $G = 6.7 \times 10^{-11} \frac{\text{N} \cdot \text{m}^2}{(\text{kg})^2}$ and r is distance of M from center of Earth. How would you reconcile these two formulas?

ie business school

#1 EUROPEAN BUSINESS SCHOOL
FINANCIAL TIMES 2013

#gobeyond

MASTER IN MANAGEMENT

Because achieving your dreams is your greatest challenge. IE Business School's Master in Management taught in English, Spanish or bilingually, trains young high performance professionals at the beginning of their career through an innovative and stimulating program that will help them reach their full potential.

- Choose your area of specialization.
- Customize your master through the different options offered.
- Global Immersion Weeks in locations such as London, Silicon Valley or Shanghai.

Because you change, we change with you.

www.ie.edu/master-management | mim.admissions@ie.edu |

1-4. The spring force is written as:

$$\vec{F}_{sp} = -k\Delta x\hat{x}$$

Where k is the spring constant. Discuss why it is necessary to have the negative sign on the right in order to cause mechanical vibrations.

1-5. Given two springs of spring constants $k_1 = 100\text{N/m}$ and $k_2 = 50\text{N/m}$, what will be the effective spring constant if the springs are connected in parallel? Why?

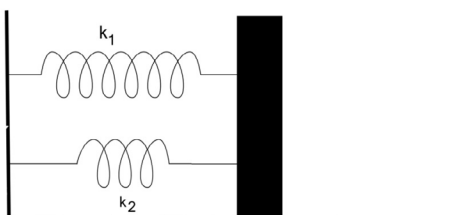

1-6. What will be the effective spring constant if the springs of problem 1-5 are connected in series?

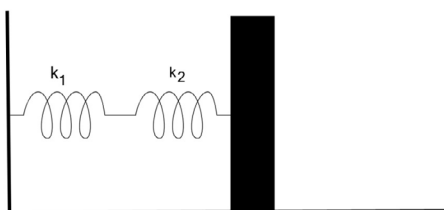

1-7. If your heart rate is 75 beats per minute what is the period and frequency of this “oscillation” ?

1-8. For a spring-mass (m) oscillator the angular frequency $\omega = \sqrt{\frac{k}{m}}$ where k is the spring constant and the period is $T_0 = \frac{2\pi}{\omega}$. For a fixed m by what factor would you change k to double (i) ω (ii) T_0 ? Why?

1-9. In problem 1-8 fix k and change m . Now what factors are needed to double (i) ω (ii) T_0 ? Why?

1-10. A spring-mass oscillator is represented by

$$x = 0.01 \sin\left(12.56t + \frac{\pi}{6}\right)m$$

Where lengths are in meters and times in seconds. Calculate its

(i) amplitude (ii) frequency (iii) phase (iv) maximum velocity (v) maximum acceleration

1-11. At room temperature in a solid, atoms oscillate typically at a frequency of 10^{13} Hz. Consider the case of copper (1 mol is 0.064 kg and has 6.02×10^{23} atoms). Suppose that while all the other atoms are at rest one atom has this frequency and estimate the effective spring constant of the “atomic spring”?

1-12. An oscillator is represented by the equation

$$x = 0.05 \sin(62.8t + \Theta)m$$

where t is in seconds.

Plot x as a function of t and calculate the times for the first zero and the first maximum if

(i) $\Theta = \frac{\pi}{3}$ (ii) $\Theta = -\frac{\pi}{3}$?

1-13. Repeat problem 1-12 with

$$x = 0.05 \cos(6.28t + \Theta)m$$

1-14. You inherit a grand father clock. Unfortunately, it loses 1 min every hour. By what fraction must you change the length of the “pendulum” to make it run true? Why?



STUDY AT A TOP RANKED INTERNATIONAL BUSINESS SCHOOL

Reach your full potential at the Stockholm School of Economics, in one of the most innovative cities in the world. The School is ranked by the Financial Times as the number one business school in the Nordic and Baltic countries.

Visit us at www.hhs.se





30.2 Problems: Week 2

2-1. A pendulum on Earth ($g_E = 9.8 \text{ m/s}^2$) has a period of 1 sec. What is its length? If you take it to the moon what will its period be there if $g_M = \frac{g_E}{6}$? If you want the period to be 1 sec on the moon by what factor must you change the length?

2-2. A spring-mass system is oscillating on a horizontal frictionless surface and its position is given by $x = 0.05 \text{ m} \cos \omega t$. For what values of x will (i) its kinetic energy be maximum, (ii) its potential energy be maximum (iii) its kinetic energy equal its potential energy.

2-3. If the system of problem S-2 is hung from a ceiling, what will be the change in its frequency? Why?

2-4. A wave on a stretched string is represented by

$$\underline{y} = 0.01 \sin(6.28x - 12.56t) \hat{y}$$

where distances are in meters and times in seconds.

(i) Is this longitudinal or transverse? (ii) What is its wavelength, frequency, velocity?

2-5. A sinusoidal wave of amplitude A and frequency ω , travelling on a stretched string carries

$$P = \frac{1}{2} A^2 \omega^2 \frac{T}{v}, \text{ where } v = \sqrt{\frac{T}{\mu}}$$

Joules of energy per second. Here T is the tension and v , the wave speed. Changing only one factor at a time how would P change if you

(i) double A (ii) halve ω or (iii) increase T by a factor of 3.

2-6. A sine wave $y_i = A_i \sin(kx + \omega t)$ is launched on one string with velocity $v = \frac{\omega}{k} \hat{x}$. At $x = 0$, it encounters a second string where velocity is v' and gives rise to a reflected wave $y_r = A_r \sin(kx - \omega t)$ and a transmitted wave $y_t = A_t \sin(k'x + \omega't)$. (i) What is the relation between ω' and ω ? Why? (ii) What determines k' ? (iii) Given that $\frac{A_r}{A_i} = \frac{v - v'}{v + v'}$ and $\frac{A_t}{A_i} = \frac{2v'}{v + v'}$ show that during reflection there is a phase change of Π if $v' < v$.

2-7. Using the result of problem 2-6 and the superposition principle, show that where the incident and reflected waves combine, nodes appear at $x = 0, n \frac{\lambda}{2} (n = 1, 2, \dots)$ and antinodes occur at $x = (2n + 1) \frac{\lambda}{4} (n = 1, 2, \dots)$.

- 2-8. A wire of length 1m and mass 0.001kg has a tension of 10^3N in it and is fixed at both ends. Calculate the frequencies of the 3rd and 5th harmonic modes.
- 2-9. In the standing wave experiment that you have performed (frequency is fixed) (a) why does the lowest ($n = 1$) mode require the largest tension (hanging mass)? (b) by what factor must you change the mass to get the $n = 3$ mode?

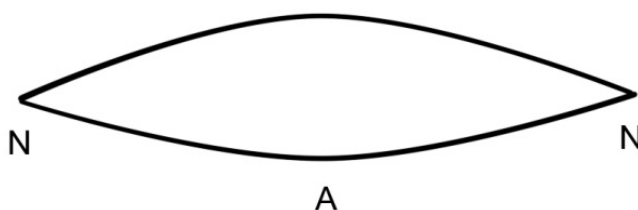

- 2-10. The intensity of a periodic sound wave of amplitude s_m and frequency ω in a gas at pressure P_o is

$$I = \frac{1}{2} s_m^2 \omega^2 \frac{\gamma P_o}{v_s}$$

where $\gamma = \frac{C_p}{C_v}$ and v_s is the speed of sound. Calculate s_m for air if $P_o = 10^5 \text{N/m}^2$, $\gamma = 1.4$, $v_s = 330 \text{m/s}$ and $I = I_o = 10^{-12} \text{Watt/m}^2$; the quietest sound that can be heard.

- 2-11. A periodic sound wave can be thought of as a displacement wave

$$s = s_m \sin(kx - \omega t)$$

or a pressure wave

$$P = P_o - \gamma P_o s_m \cos(kx - \omega t)$$

Why is the pressure wave always $\frac{\pi}{2}$ out of phase with the displacement, that is, why is pressure variation maximum where displacement is zero and vice versa?

- 2-12. In air the speed of sound at room temperature is about 330m/s . What must be the wavelengths of mechanical waves to be called sound?

2-13. The speed of sound in a gas is written as

$$V_s = \sqrt{\frac{\gamma k_B T}{5m}} \quad \text{where } \gamma = \frac{C_p}{C_v}$$

Why is there a “ γ ” in this equation?

2-14. Using the formula of 2-13 compare the speeds of sound in Helium [$\gamma = \frac{5}{3}, m = 4mp$] and air [$\gamma = \frac{7}{5}, m \cong 30mp$].

2-15. Compare the speed of sound in He ($\gamma = \frac{5}{3}$) with the r.m.s. speed $v_{rms} = \sqrt{\frac{3k_B T}{m}}$ of He atoms.



#1
in eco-friendly
attitude

**STUDY AT
LINKÖPING UNIVERSITY, SWEDEN**
RANKED AMONG TOP 50 UNIVERSITIES UNDER 50

Interested in Strategy and Management in International Organisations? Kick-start your career with a master's degree from Linköping University, Sweden.

→ **Click here!**

 **Linköping University**

30.3 Problems: Week 3

- 3-1. The human ear has a “drum” which is roughly circular with a diameter of 1cm. If a 60dB sound wave lands on your ear how much power (energy/sec) does it deliver? Why? What is the pressure amplitude of this wave if frequency is 440Hz?
- 3-2. You are standing on the platform when a train travelling at 30mph passes by. If the engineer blows a horn at 300Hz what is the change in the frequency of the sound perceived by you as the engine goes by. [assume that speed of sound is 330m/sec]
- 3-3. Suppose you are driving toward a hill at 60mph and you blow your horn at 500Hz. What is the frequency of the “echo” you will perceive as the reflected wave gets back to you? Why?
- 3-4. A piano tuner uses a tuning fork to set the wire tension for a chosen string. Initially, she tunes the “A” string by ear and sounding it along with her 440Hz fork perceives 4 beats. What are the frequencies of the sound from the string? She then tightens the string very slightly and now hears 6 beats. What was the frequency after the initial tuning? Why?
- 3-5. Consider the copper penny in your pocket. How many electrons must you remove from it so it will acquire a charge of $+10^{-9}\text{C}$?
- $$(e = -1.6 \times 10^{-19} \text{ C})$$
- 3-6. Cu has a molar mass of 64gm and a density of 8.95gm/cm^3 . We are told that it is a conductor because each Cu atom contributes one electron which is free to move. How many mobile electrons would you estimate in one m^3 of Cu?
- 3-7. In the Bohr model of the hydrogen atom the electron is in uniform circular motion around the proton, the centripetal force being due to the Coulomb force. If so, what must be the speed of the electron if the orbit radius is $0.5 \times 10^{-10} \text{ m}$.
- $$(e = -1.6 \times 10^{-19} \text{ C})$$
- 3-8. The picture shows two equal positive charges q . One of them is fixed at $x = 0$ and the other is attached to a spring and free to slide on a smooth frictionless surface. At equilibrium the separation between the charges is 2mm, the spring length is changed by 1mm and the spring constant is 10^3N/m .

(i) Is the spring squeezed or stretched? Why? (ii) Calculate q .

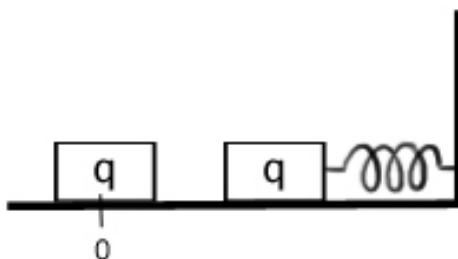

3-9. Two equal negative charges are suspended by two $l = 1\text{m}$ long strings. At equilibrium the angle Θ is 5° . If their masses are 10^{-3}kg , what is q ?

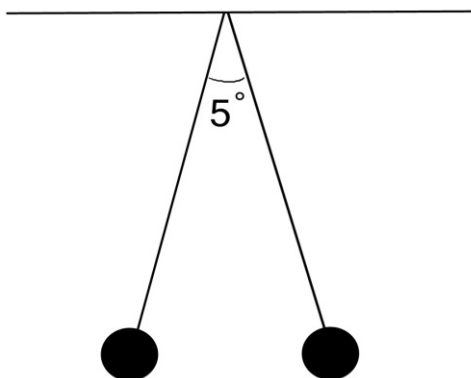

3-10. Two equal positive charges of $5\mu\text{C}$ each of mass 0.05kg , are lying on a smooth frictionless inclined plane, $\Theta = 30^\circ$. The lower charge is fixed. What must be their separation l if the upper charge is to be at equilibrium?

3-11. Two charges, $1\mu\text{C}$ and $16\mu\text{C}$ are fixed at $x = 0$ and $x = 5\text{m}$. Where would you place a charge of $-5\mu\text{C}$ so that it experiences no force? Why?

3-12. A dipole consists of two equal and opposite charges $\pm 1\mu\text{C}$ located at $x = m0.01\text{m}$. Calculate the force, magnitude and direction experienced by a charge located at (i) $x = 1\text{m}$, (ii) $y = 1\text{m}$. [Express your result in terms of the dipole moment vector $\underline{p} = q\underline{l}$ where magnitude of \underline{l} is the charge separation, and the direction of \underline{l} is from negative to positive q .]

3-13. Two equal charges q are located at $x = -a$ and $x = +a$. Show that if you place a charge $-q$ on the y -axis at $y \ll a$ it will experience a force

$$\underline{F}_E = \frac{-2k_e q^2 y}{a^3} \hat{y}$$

If you let the negative charge go it will exhibit linear harmonic motion

- (i) Calculate the frequency of this motion $q = 1\mu C$ if, $a = 1m$ and $mass = 10^{-4}kg$ ($k_e = 9 \times 10^9 \frac{N \cdot m^2}{C^2}$). (ii) Calculate the length of a simple pendulum which will have the same period.

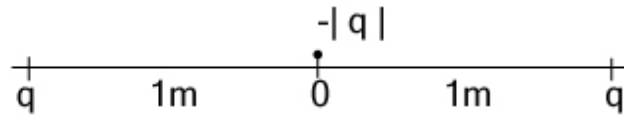

- 3-14. Three equal charges are symmetrically located on the circumference of a circle, as shown. What is the force experienced by a charge placed at the center? Why?

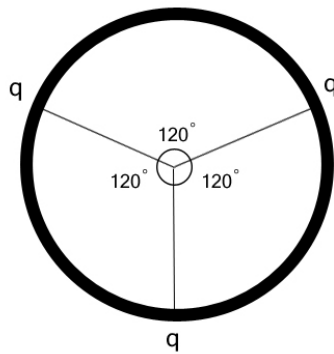

- 3-15. Sketch the \underline{E} -field lines for charges of $+1\mu C$ and $-2\mu C$ placed at $x = 0$ and $x = 1m$ respectively.

30.4 Problems: Week 4

- 4-1. You are given a charge q and a device to measure force. How would you discover presence of an \underline{E} - field.
- 4-2. A point charge is located at $r = 0$ and produces an \underline{E} - field. of $-100N/C\hat{r}$ at $\underline{r} = 2m\hat{x}$.
(i) What is the charge? (ii) What is the magnitude and direction of \underline{E} at $\underline{r} = 4m\hat{x}$?
- 4-3. A dipole is located on the x -axis as shown. Charges of $\mp/10\mu C$ fixed at $\mp 0.01m$. Show that at y very large ($y \gg 0.1m$) the \underline{E} field is

Where $\underline{p} = 2 \times 10^{-7} C - m\hat{x}$



"I studied English for 16 years but...
...I finally learned to speak it in just six lessons"
Jane, Chinese architect

ENGLISH OUT THERE

Click to hear me talking before and after my unique course download

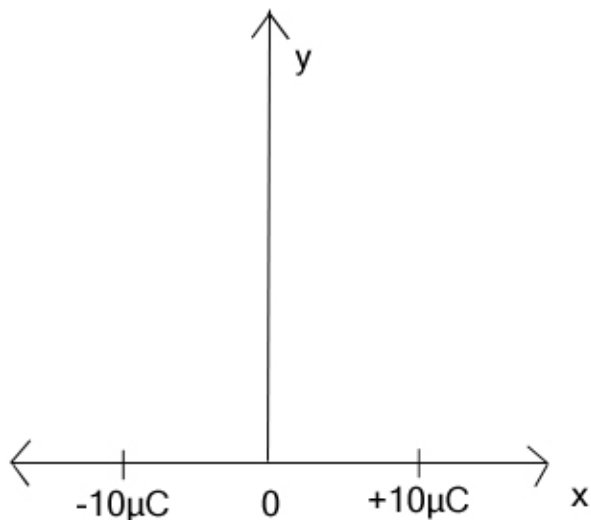

- 4-4. A small sphere of mass 0.001kg and charge q is hanging at an angle of 10° with respect to the vertical in a constant \underline{E} field of $-100\text{N}/\text{C}\hat{x}$.
- (i) Is q positive or negative? Why? (ii) What is the magnitude of q ?

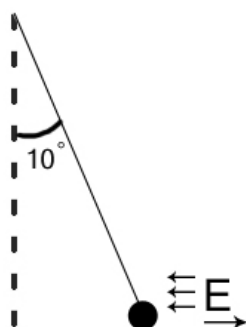

- 4-5. Shown are two parallel plates which produce a constant $\underline{E} = -50\text{N}/\text{C}\hat{y}$ for $0 \leq x \leq 0.15\text{m}$. At $x = 0, y = 0$ an electron with velocity $\underline{v} = 10^7\text{m}/\text{sec}\hat{x}$ is introduced between the plates.
- (i) What is the acceleration of the electron? (ii) What is the velocity when $x = l$? (iii) What is its position when $x = l$? (iv) Where will it go and hit a screen which is located at $L = 1\text{m}$? (incidentally, this device is used to move electrons across the screen of an oscilloscope/TV) *Neglect gravity*

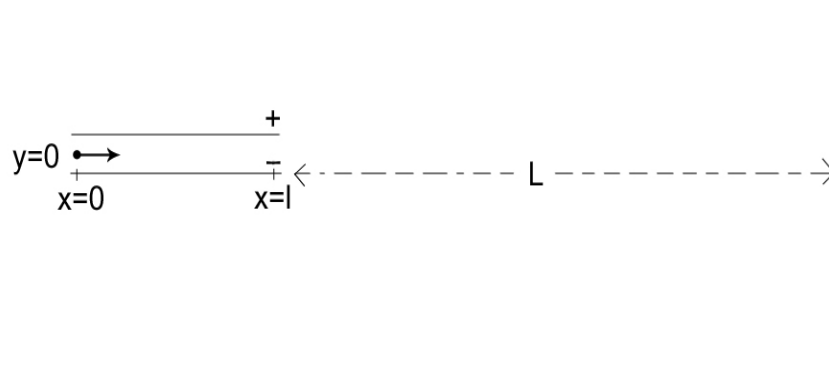

- 4-6. A flat disk of radius 1m is rotated about the y-axis in a region where a constant $\underline{E} = 60N/C \hat{x}$ is present. Calculate the maximum and minimum flux of \underline{E} through the disk.

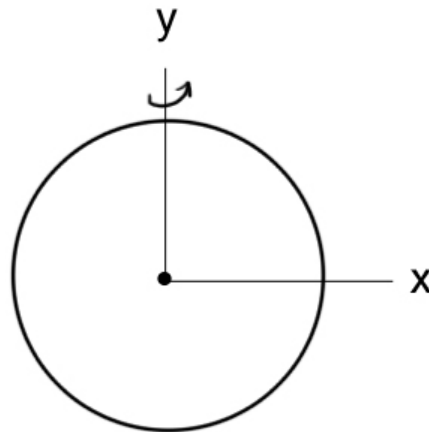

- 4-7. A point charge Q is located at the origin ($r = 0$). Knowing that \underline{E} - field lines can only stop/start at a charge, show that the total flux of \underline{E} through any closed surface enclosing Q is

$$\Sigma_c \underline{E} \cdot \underline{\Delta A} \equiv \frac{Q}{\epsilon_0}$$

- 4-8. Shown is a cone lying in a uniform \underline{E} field of magnitude 30N/C directed at an angle of 30° with respect to the cone axis (y-axis).
 (i) Are there any sources/sinks of \underline{E} inside the cone? Why? (ii) What is the flux of \underline{E} through the curved surface of the cone?

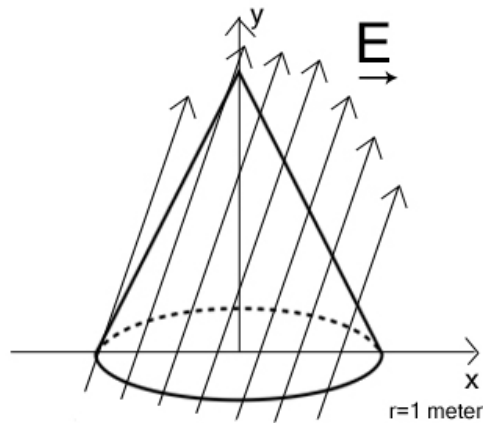

4-9. Inside a closed shell S the following charges are located

$$Q_1 = 10\mu\text{C}, \quad Q_2 = 20\mu\text{C}$$

$$Q_3 = 30\mu\text{C}, \quad Q_4 = -60\mu\text{C}$$

(i) What is the totally flux of \underline{E} through S ? Why? (ii) What is the \underline{E} - field at any point on S ? Why?

Excellent Economics and Business programmes at:



university of
 groningen



**“The perfect start
 of a successful,
 international career.”**

CLICK HERE
 to discover why both socially
 and academically the University
 of Groningen is one of the best
 places for a student to be

www.rug.nl/feb/education



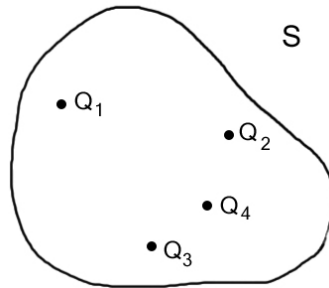

- 4-10. Shown is a conducting sphere with internal radius 1m and external radius 2m. If there is a charge of $10\mu\text{C}$ located at the center of the sphere ($r = 0$) what charges will appear on its surfaces and what are the \underline{E} fields at $r < 1\text{m}$ and $r > 2\text{m}$?

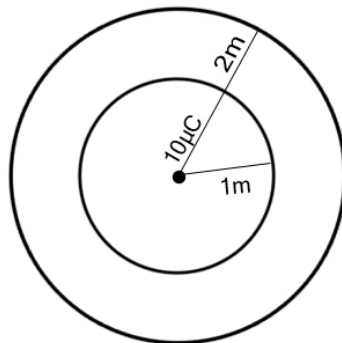

- 4-11. A conducting sphere of diameter 1m carries a charge of $100\mu\text{C}$. Under stationary conditions, where would this charge be located? Why?
- 4-12. In problem 4-11, what would be the force experienced by a point charge of $1\mu\text{C}$ if it was located at
 (i) 0.49m (ii) 0.51m from the center of the conducting sphere? Why?
- 4-13. A conductor of thickness d is placed in a uniform \underline{E} -field, $\underline{E} = 100\text{N/C } \hat{x}$ as shown. Under stationary conditions what are the charge densities that appear on its surface? Why?

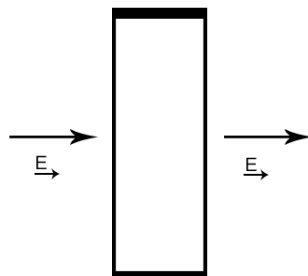

- 4-14. An insulating sphere of radius 1m has a small diametric hole in it as shown. It carries a charge of $50 \mu\text{C}$ uniformly distributed over its volume. If we release a charge $q = -1 \mu\text{C}$ at the point P what will be the motion of q ? Why?

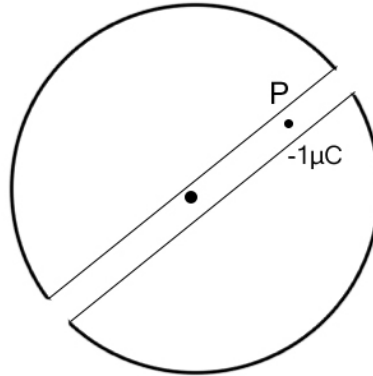

- 4-15. What is a conservative force? Give one example.

In the past four years we have drilled

89,000 km

That's more than **twice** around the world.

Who are we?
We are the world's largest oilfield services company¹. Working globally—often in remote and challenging locations—we invent, design, engineer, and apply technology to help our customers find and produce oil and gas safely.

Who are we looking for?
Every year, we need thousands of graduates to begin dynamic careers in the following domains:

- Engineering, Research and Operations
- Geoscience and Petrotechnical
- Commercial and Business

What will you be?

careers.slb.com

Schlumberger

¹Based on Fortune 500 ranking 2011. Copyright © 2015 Schlumberger. All rights reserved.



30.6 Problems: Week 6

- 6-1. What is EMF (electromotive force)? [Hint: It is not a force]
- 6-2. In order to place a charge Q on a capacitor C_0 the battery must do $\frac{Q^2}{2C_0}$ joules of work. Where does all this energy go? Why?
- 6-3. Use the result of 6-2 for a parallel plate capacitor with air or vacuum between the plates to show that 1m^3 of an \underline{E} -field stores $\frac{1}{2}\epsilon_0 E^2$ joules of energy.
- 6-4. A current of 1amp exists in a resistor for 4 min. How many (a) coulombs and (b) electrons pass through any cross-section?
- 6-5. If the resistor of problem 6-4 is a cylinder of radius 0.001m, what is the current density?
- 6-6. Two conductors A and B are made of the same material and have the same length. However, A is solid and has a diameter of 1m, B is hollow with an outer diameter of 2mm and an inner diameter of 1mm. Calculate the resistance ratio R_A / R_B .
- 6-7. A wire with resistance 6Ω is drawn out so that its length is tripled. If neither density nor the resistivity change, what will be the resistance of the longer wire?
- 6-8. Using the result of 3-6, if there is a current of 1amp in a Cu wire of diameter 1mm, what will be the drift speed (V_D) of the electrons? [$|e| = 1.6 \times 10^{-19} \text{C}$]? Why?
- 6-9. If in 6-8 the diameter is doubled by what factor will V_D change? Why?
- 6-10. When the resistance(R) is independent of the current one writes the so-called Ohm's Law

$$V=IR \quad \text{-- (1)}$$
 Now $I = \underline{J} \cdot \underline{A}$ where \underline{J} is the current density and A the area of the conductor, $R = \frac{l}{\sigma A}$ where l is the length and σ the electrical conductivity. Show that Eq. (1) implies the fundamental relationship $\underline{J} = \sigma \underline{E}$ where \underline{E} is the field driving the current.
- 6-11. The conductivity of copper is $5.9 \times 10^7 (\Omega - m)^{-1}$. Use the result of problem 3-6 (for n) to estimate the time τ between collisions in Cu if

$$\sigma = \frac{ne^2\tau}{m}$$

$$e = 1.0 \times 10^{-19} \text{C}; m = 9 \times 10^{-31} \text{kg}$$

- 6-12. At room temperature the resistivities of Copper and Iron are $1.7 \times 10^{-8} \Omega - m$ and $10 \times 10^{-8} \Omega - m$. A composite wire is made up of 1m each of Cu and Fe connected as shown. The diameters are 1mm. (i) What is the total resistance? (ii) What is the current if there is a voltage difference of 10V between A and B? (iii) What is the potential at C?

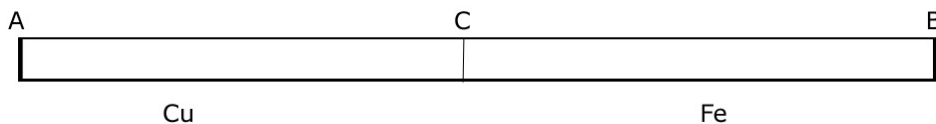

- 6-13. How much thermal energy per hour is generated by the current in problem 6-12? Why?
- 6-14. In the circuit shown, what is the equivalent resistance across AB? Next, close the switch and calculate (i) the currents in the resistors and (ii) the potential drop across each resistor.

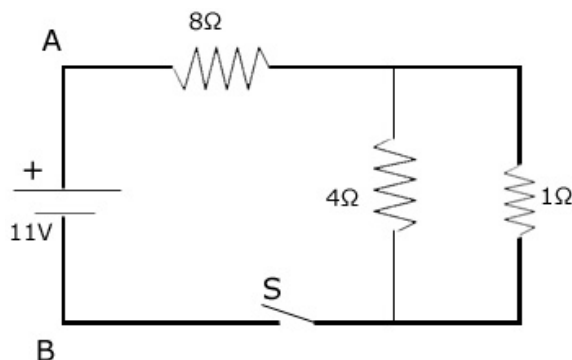

- 6-15. In the circuit shown “ r ” is the internal resistance of the battery. Calculate the power dissipated in the load R and show that the power becomes very small when $R \ll r$ or $R \gg r$.



- 6-16. In problem 6-12 if the wires are connected as shown here, now what is the resistance AB and the current in each if $V_{AB} = 10V$?

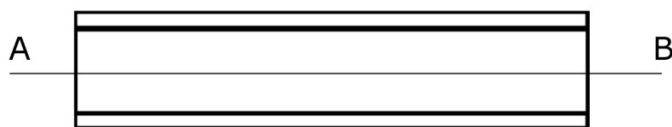

30.7 Problems: Week 7

- 7-1. Write down the physical bases of Kirchhoff's rules for electrical circuits.
- 7-2. Calculate the currents in the resistors and the potential drops across them.

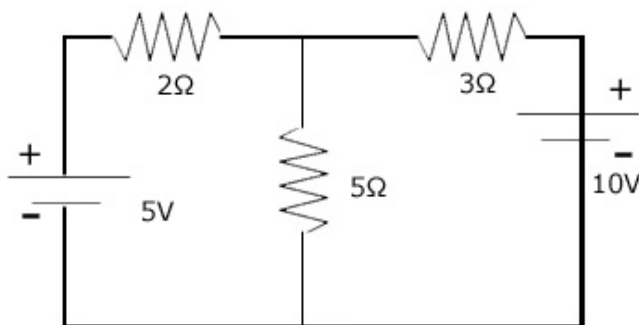

American online LIGS University

is currently enrolling in the
Interactive Online **BBA, MBA, MSc,**
DBA and PhD programs:

- ▶ enroll **by September 30th, 2014** and
- ▶ **save up to 16%** on the tuition!
- ▶ pay in 10 installments / 2 years
- ▶ Interactive **Online** education
- ▶ visit www.ligsuniversity.com to find out more!

Note: LIGS University is not accredited by any nationally recognized accrediting agency listed by the US Secretary of Education. More info [here](#).



7-3. In the circuit shown, $I_1 = 3\text{amp}$ and ϵ and R are not given. Calculate I_2 and I_3 .

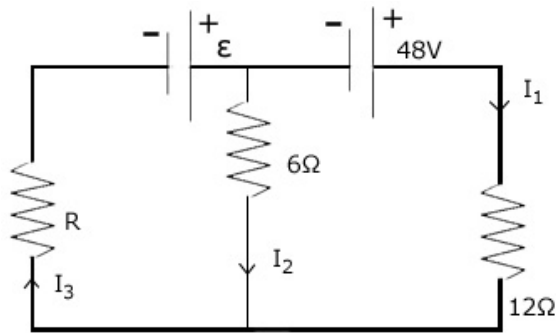

7-4. Calculate the equivalent resistance and the currents in all the resistors if

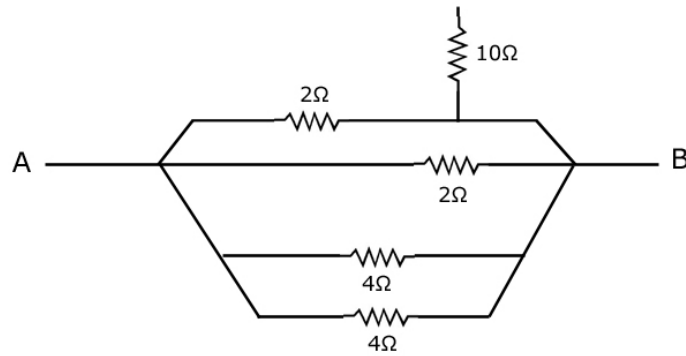

7-5. Show that RC has the dimensions of time.

7-6. Why does the characteristic time of an RC circuit depend on both R and C ?

7-7. $R = 10k\Omega$ and $C = 10\mu F$ at $t = 0$, S_2 is open and S_1 is closed. Calculate potential across C and the current in R at (i) 0.1sec (ii) 0.3sec (iii) $t = 1\text{sec}$.

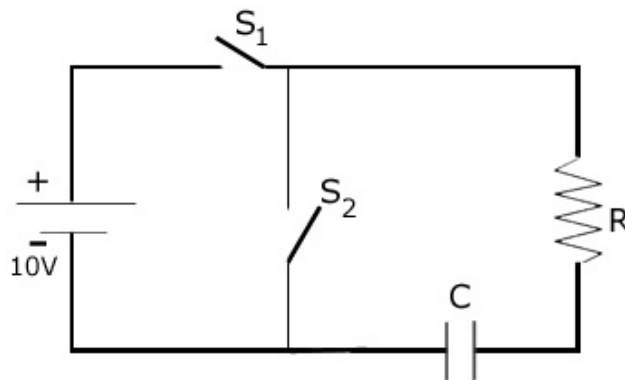

- 7-8. A long time later the switch S_1 in the circuit of problem 7-7 is opened and S_2 is closed, now calculate V_C and i at times (i) 0.1sec (ii) 0.3sec and (iii) 1sec after opening the switch. [Indicate direction of current].
- 7-9. Shown are two circuits

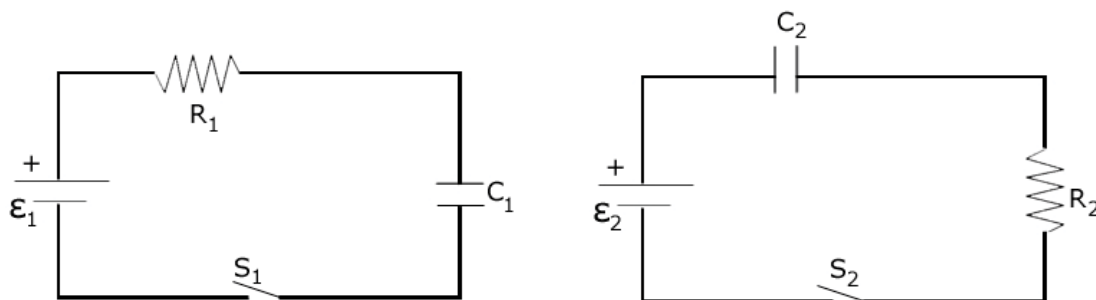

Given

$$R_1 = 100k\Omega$$

$$C_1 = 10\mu F$$

$$\varepsilon_1 = 9V$$

$$R_2 = 200k\Omega$$

$$\varepsilon_2 = 9V$$

If both switches are closed at $t = 0$, which capacitor voltage will reach 6V first? Why?

- 7-10. In the circuit shown, S is closed at $t = 0$. (i) What is the current in the circuit at $t = 0$? (ii) What is the potential across C a long time later? (iii) What is the current in the circuit a long time later? Justify your answers.

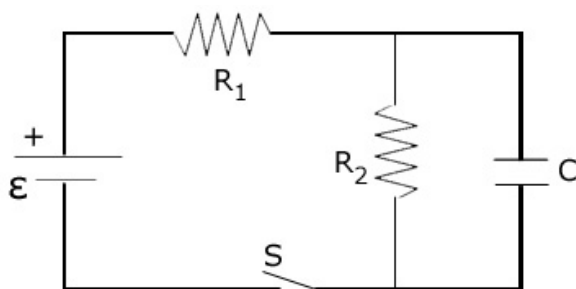

- 7-11. How many time constants must elapse before the capacitor in an RC circuit reaches a charge within 1% of its final (equilibrium) value?
- 7-12. A $1000\mu F$ capacitor is charged to 100V and then allowed to discharge through a heating coil immersed in 0.02kg of water at 20°C. What will be the rise in the temperature of water (sp ht of water is 1cal/gm). (neglect the heat capacity of the heater)

- 7-13. Often you see birds sitting on a high-voltage power line. Typically the Cu wire diameter is 1" and the separation of the bird's feet is about 1.5". If the current in the wire is about 40A, what is the voltage difference across the bird?
- 7-14. How do you distinguish between an \underline{E} field and a \underline{B} field?
- 7-15. In the presence of a $\underline{B} = -B\hat{z}$, a positively charged particle with velocity $\underline{v} = v\hat{x}$ at $t = 0$, will go around on a circle of radius $R = \frac{MV}{qB}$. How much work is done by \underline{B} as the particle goes half-way around the circle? Why?

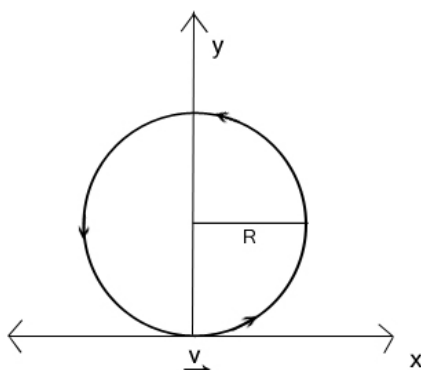

.....Alcatel-Lucent 

www.alcatel-lucent.com/careers

What if you could build your future and create the future?

One generation's transformation is the next's status quo. In the near future, people may soon think it's strange that devices ever had to be "plugged in." To obtain that status, there needs to be "The Shift".



30.8 Problems: Week 8

8-1. The curves show the paths (in xy -plane) of three particles in the presence of a constant \underline{B} field $\underline{B} = -B\hat{z}$

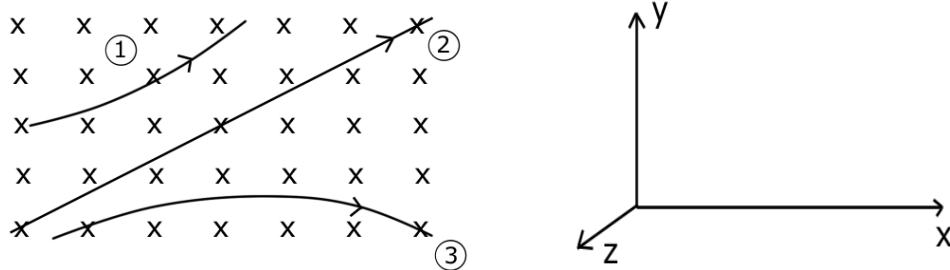

what can you say about the charge carried by each particle? Why?

8-2. What is the force experienced by a conductor aligned along the z -axis if it carries a current of 10amps and is located in a $\underline{B} = -0.1T\hat{z}$ field? Why?

8-3. A cyclotron has an oscillator frequency of 12MHz and a DEE radius of 53cm. What value of \underline{B} would you need to accelerate deuterons (positive charge $1.6 \times 10^{-19} C$).

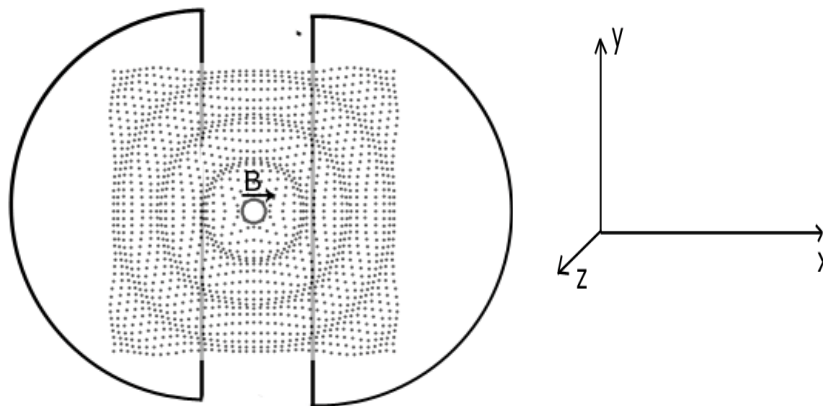

8-4. In a constant \underline{B} field a charge with velocity $\underline{V} \perp \underline{B}$ has a circular path of radius $r = \frac{MV}{qB}$. (i) If $\underline{B} \parallel \hat{z}$ what is the plane of the path. (ii) If you double V what happens to the angular velocity of the charge? Why?

- 8-5. A proton travelling at $10^5 \text{ m/s } \hat{x}$ is introduced between two parallel plates which have an $\underline{E} = 100 \text{ N/C } \hat{y}$. What \underline{B} field would you apply so that the proton goes through un-deflected? [This is the principle of the velocity selector].

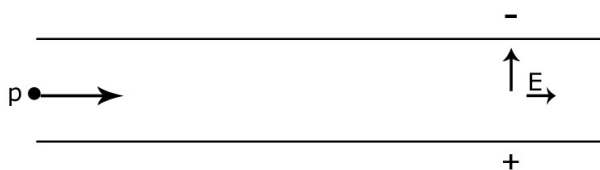

- 8-6. A 5-turn coil of radius 50cm is lying flat in the xz -plane. If it carries a current of 10amps flowing counter clockwise, what is the magnetic moment (magnitude and direction).

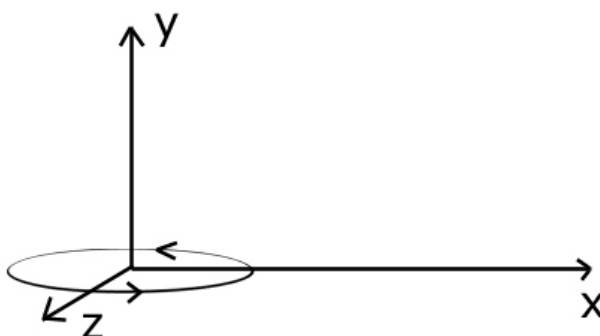

- 8-7. If you apply a \underline{B} field of 0.1T, at an angle of 30° with respect to the y -axis, to the coil of problem 8-6, what is the torque (magnitude and direction) on the coil?
- 8-8. The Biot-Savart law tells us that a current I flowing through a conducting wire of length $\underline{\Delta l}$, produces a \underline{B} -field at $r(\perp \underline{\Delta l})$ given by

$$\underline{\Delta B} = \frac{\mu_0}{4\pi} I \frac{\underline{\Delta l} \times \underline{r}}{r^3}$$

Show that the \underline{B} -field lines circulate around the current.

- 8-9. Since the \underline{B} -field due to a current swirls around it (like water circulates as it flows out of a bath tub) Ampere taught us that the circulation of the \underline{B} -field around a closed loop

$$\oint_C \underline{B} \cdot \underline{\Delta l}$$

is determined solely by the currents flowing through the surface on which the loop is drawn.

That is,

$$\oint_C \underline{B} \cdot \underline{\Delta l} = \mu_0 \Sigma I_i$$

where μ_0 is a fundamental constant

$$\mu_0 = 4\pi \times 10^{-7} \frac{T \cdot m}{A}$$

Supposing we have a single current I flowing along the y -axis. Please use ampere's law and the symmetry of the problem to show that the \underline{B} -field at a point P in the xz - plane is given by

$$\underline{B}(r) = \frac{\mu_0 I}{2\pi r} \hat{\Phi}$$

where r is distance between P and the y -axis?

- 8-10. A tightly wound long solenoid consists of a large number of closely spaced rings with a common axis (see figure). It produces a uniform field inside it. Use Ampere's law to show that for the case shown (ccw current in solenoid)

$$\underline{B} = -\mu_0 n I \hat{x}$$

where $n =$ No. of turns/meter of the solenoid. ($n = N/L$)

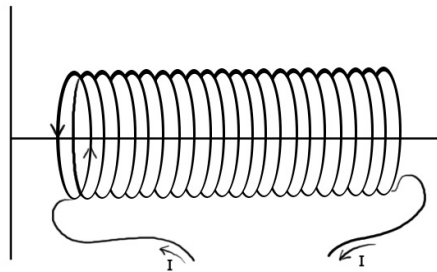

Join the best at
the Maastricht University
School of Business and
Economics!

Top master's programmes

- 33rd place Financial Times worldwide ranking: MSc International Business
- 1st place: MSc International Business
- 1st place: MSc Financial Economics
- 2nd place: MSc Management of Learning
- 2nd place: MSc Economics
- 2nd place: MSc Econometrics and Operations Research
- 2nd place: MSc Global Supply Chain Management and Change

Sources: Keuzegids Master ranking 2013; Elsevier 'Beste Studies' ranking 2012; Financial Times Global Masters in Management ranking 2012

Maastricht University is the best specialist university in the Netherlands (Elsevier)

Visit us and find out why we are the best!
Master's Open Day: 22 February 2014

www.mastersopenday.nl



- 8-11. In a mass spectrometer, the beam at 0 consists of two kinds of particles with same mass (M) but different charges q_1, q_2 entering with a velocity $\underline{v} = v\hat{y}$. For $\underline{B} = -B\hat{z}$ and the paths shown, what is the sign of the charge (+ive or -ive)? Where will the larger charge land, P_1 or P_2 ? Justify your answer.

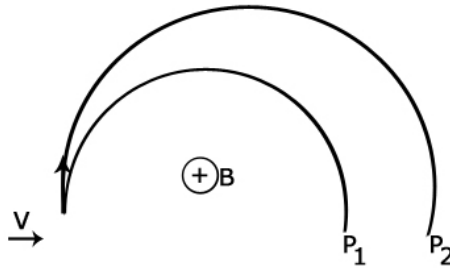

- 8-12. Why do two parallel currents attract one another?
- 8-13. Shown is a coil of width b and length ℓ suspended vertically in a \underline{B} -field. How would you make it work like a motor? The coil is free to rotate about its vertical axis.

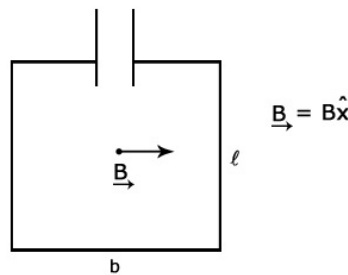

- 8-14. A coil of cross-section $\underline{A} = (2 \times 3)m^2 \hat{n}$ is being rotated about the vertical in the presence of a constant $\underline{B} = 0.2T\hat{z}$. What is the maximum and minimum flux of \underline{B} through the coil? Why?
- 8-15. Imagine that a cube of side 1m is located at a height of 10m above the Earth's surface. If the flux of \underline{B} through 3 of the faces is $90\mu T - m^2$ what must be the flux through the other three? Why?
- 8-16. Write an essay on
 "What is a Bar Magnet"
 Starting from the idea that a single electron is a "bar magnet" of magnetic moment $9.27 \times 10^{-24} A - m^2$.
- 8-17. Why does a bar magnet attract a piece of iron?

30.9 Problems: Week 9

- 9-1. We have learnt that the flux of \underline{B} through any closed surface is always equal to **ZERO**, what does it tell you about (i) the elementary generators of \underline{B} and (ii) the fundamental property of \underline{B} field lines (in contrast to the field lines of a Coulomb \underline{E}).
- 9-2. What is the difference between a Coulomb \underline{E} -field and a non-Coulomb \underline{E} -field?
- 9-3. What is the total flux of a non-Coulomb \underline{E} -field through a closed surface? Why?
- 9-4. A uniform $\underline{B} = -B\hat{z}$ is normal to a conducting ring of diameter 10cm. If the resistance is 1Ω and you want to induce a clockwise current of 10Amps in the ring, at what rate must you change \underline{B} ?

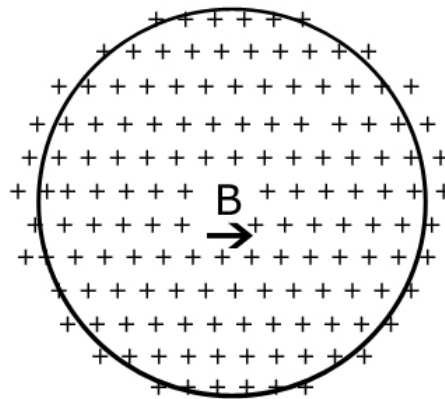

- 9-5. The figure shows a copper rod sliding on smooth conducting rails in the presence of a uniform $\underline{B} = 1T\hat{z}$. If $v = 5m/s$ and $a = 10cm$, what is the induced ϵ_{mf} in the rod and which end of it is positive? Incidentally, do you need to apply a force to move the rod?

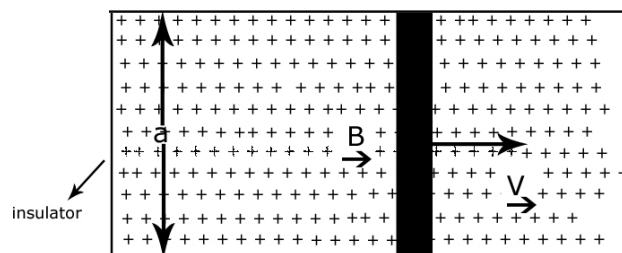

- 9-6. Same situation as in problem 9-5 but now there is a resistor $R = 2\Omega$ between the rails. (i) What is the current in the circuit? (ii) Now do you need a force to move the rod?

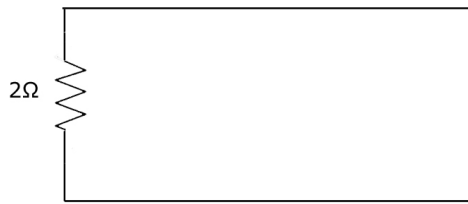

- 9-7. A circular coil of radius r and resistance R is lying in the xz -plane in a region where a uniform $\underline{B} = B\hat{y}$ is present. Show that if you flip the coil through 180° about the x -axis, a charge

$$Q = \frac{2B\Pi r^2}{R}$$

will flow around it.

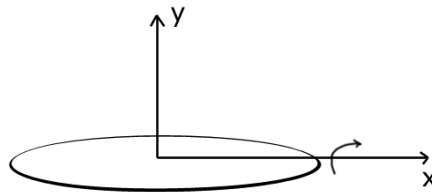

> Apply now

REDEFINE YOUR FUTURE
**AXA GLOBAL GRADUATE
 PROGRAM 2015**

redefining / standards 

agence.cdg. © Photonistop

- 9-8. The 0.1m long rod of problems 9-5 and 9-6 moves at $5\text{m/s } \hat{x}$ in a uniform field of $1T\hat{z}$. What emf appears across the rod? Why?

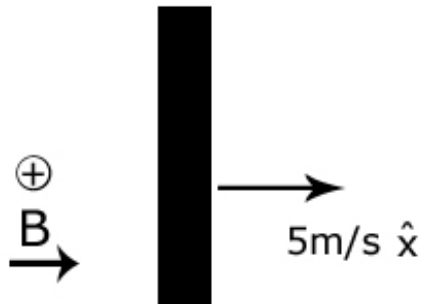

- 9-9. How would you make the coil shown in problem 8-13 work like an a.c. generator?
- 9-10. In problem 9-9 show that the generated emf is maximum (zero) when the flux of the \underline{B} -field through the coil is zero (maximum).
- 9-11. Show that $\frac{L}{R}$ has the dimensions of time.
- 9-12. Why does the time constant of an L-R circuit depend on both L and R?
- 9-13. In order to establish a current I in an inductor L the battery must do $U_B = \frac{1}{2}L I^2$ Joules of work. Where does all this energy go? Why?
- 9-14. Apply the formula of the previous problem to a solenoid to show that 1m^3 of a \underline{B} field stores

$$\eta_B = \frac{B^2}{2\mu_0}$$

Joules of energy.

9-15. For the circuit shown, (i) what is the time constant? (ii) How long after closing the switch will the current reach 90 percent of its final value?

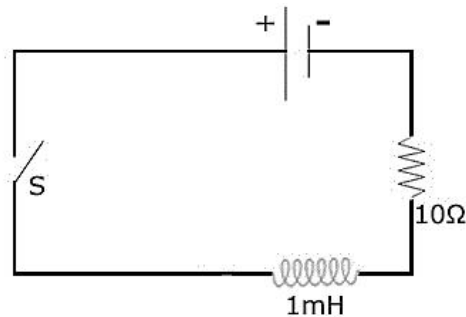

9-16. In the circuit shown, what is the current (i) immediately after S is closed, (ii) a long time later? Why?

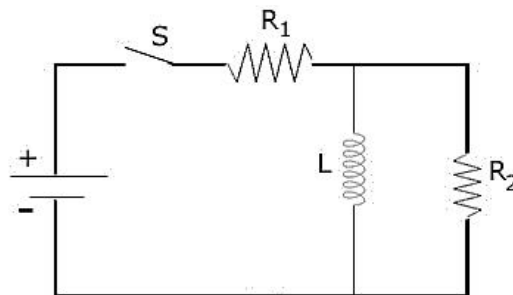

Empowering People. Improving Business.

BI Norwegian Business School is one of Europe's largest business schools welcoming more than 20,000 students. Our programmes provide a stimulating and multi-cultural learning environment with an international outlook ultimately providing students with professional skills to meet the increasing needs of businesses.

BI offers four different two-year, full-time Master of Science (MSc) programmes that are taught entirely in English and have been designed to provide professional skills to meet the increasing need of businesses. The MSc programmes provide a stimulating and multi-cultural learning environment to give you the best platform to launch into your career.

- MSc in Business
- MSc in Financial Economics
- MSc in Strategic Marketing Management
- MSc in Leadership and Organisational Psychology

www.bi.edu/master



30.10 Problems: Week 10

10-1. The pictures show two oscillators.

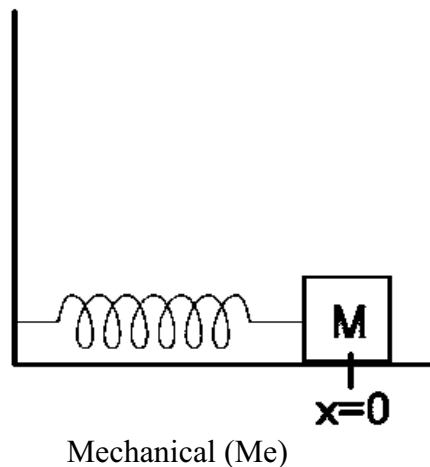
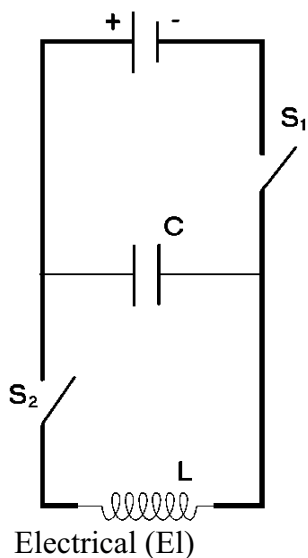

In Me the mass is at rest at $x = 0$ and the spring is relaxed. We pull M to $x = A$ and release it, thereby causing oscillations. In El, first S_1 is closed, capacitor is charged to Q , then S_1 is opened and S_2 is closed, again oscillations ensue. Write down the energy equations for the two systems and explain why the oscillations occur.

10-2. Shown are three circuits.

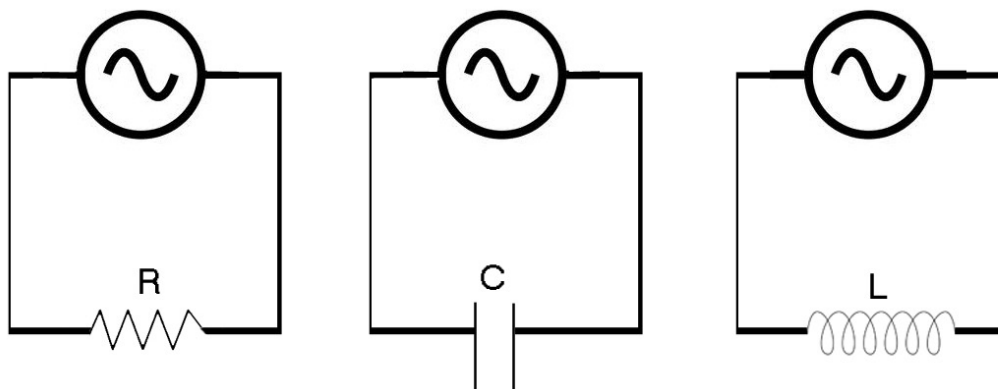

In each case the output of the ac generator is $\epsilon = \epsilon_m \sin \omega t$. We have learned that the currents are $i_R = \frac{\epsilon_m}{R} \sin \omega t$, $i_C = \epsilon_m C \omega \cos \omega t$, $i_L = \frac{-\epsilon_m}{\omega L} \cos \omega t$. Draw appropriate diagrams to show that (i) i_R is in phase with ϵ , (ii) i_C is $\frac{\pi}{2}$ ahead of ϵ and (iii) i_L is $\frac{\pi}{2}$ behind ϵ .

- 10-3. The output of the generator is $\varepsilon = \varepsilon_m \sin \omega t$, ε_m is fixed but the frequency can be set by you. X is an unknown element. Identify X if on doubling the frequency the current (i) increases by a factor of 2, (ii) reduces by a factor of 2, (iii) remains unaltered.

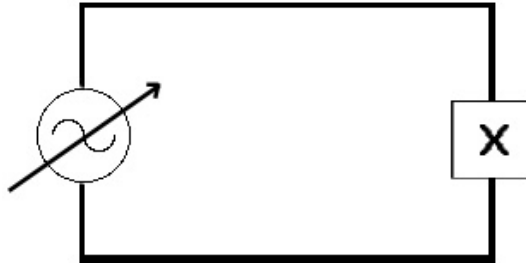

- 10-4. $\varepsilon = (150 \sin \omega t)$ Volts

$$R = 100\Omega$$

Calculate

1. Root-mean square (r.m.s) voltage
2. Root mean square current
3. Energy absorbed by R per second.

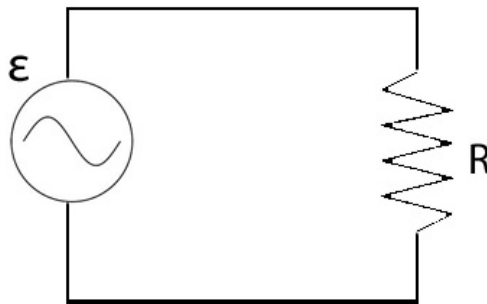

- 10-5. The ac in your house has an r.m.s. voltage of 110–115V. What is the peak (maximum) voltage?

- 10-6. If $\varepsilon = 5(\sin \omega t)$ Volts and $f = 600\text{Hz}$ and $i_m = 10^{-3}\text{amp}$ what is L? How much energy is absorbed by L in one cycle? Why?

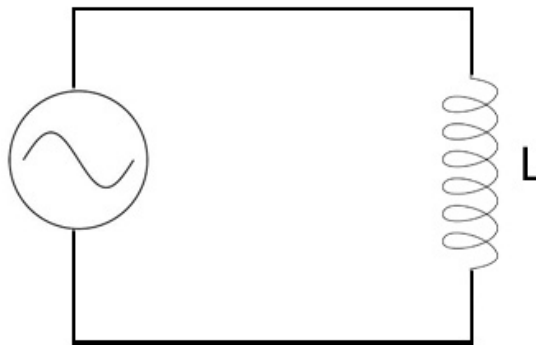

10-7. In the circuit of problem 10-6 replace L by C. If the current remains the same what is C?

10-8. In the circuit shown the current amplitude is

$$i_m = \frac{\varepsilon_m}{\sqrt{R^2 + \left(\omega L - \frac{1}{\omega C}\right)^2}}$$

If you vary ω , $i_m \rightarrow 0$ both when $\omega \rightarrow 0$ or $\omega \rightarrow \infty$. Why?

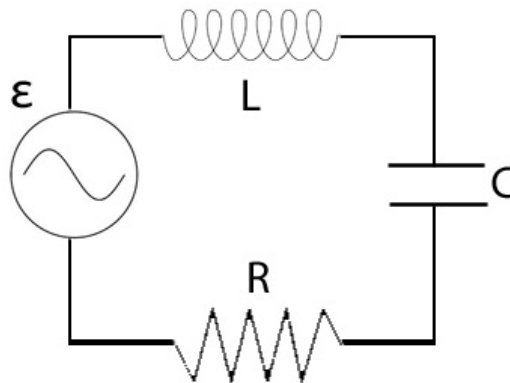

Need help with your dissertation?

Get in-depth feedback & advice from experts in your topic area. Find out what you can do to improve the quality of your dissertation!

Get Help Now



Go to www.helpmyassignment.co.uk for more info



Helpmyassignment

10-9. In the circuit of 10-8, the current is

$$i = i_m \sin \omega t$$

the potential is

$$v = \varepsilon_m \sin(\omega t + \Phi)$$

where

$$\tan \Phi = \frac{\omega L - \frac{1}{\omega C}}{R}$$

and

$$i_m = \frac{\varepsilon_m}{Z} \text{ with } Z = \sqrt{R^2 + \left(\omega L - \frac{1}{\omega C}\right)^2}$$

Show that the average power absorbed is

$$\langle P \rangle = \frac{\varepsilon_m^2}{2R} \cos^2 \Phi$$

Hints: Averages $\langle \sin^2 \omega t \rangle = \frac{1}{2}$, $\langle \sin \omega t \cos \omega t \rangle = 0$

10-10. When Maxwell looked at the field equations

$$\sum_C \underline{B} \cdot \underline{\Delta \ell} = \mu_0 \sum I_i \quad -(1)$$

and

$$\sum_C \underline{E}_{NC} \cdot \underline{\Delta \ell} = -\frac{\Delta \Phi_B}{\Delta t} \quad -(2)$$

where $\Phi_B = \underline{B} \cdot \underline{A}$ flux of \underline{B} through area \underline{A} and \underline{E}_{NC} is the non-coulomb \underline{E} surrounding \underline{A} ; he claimed that Eq (1) was “incomplete”. Do you notice the reason for his concern?

10-11. What is the difference between a conduction current and a displacement current?

30.11 Problems: Week 11

11-1. Show that $\frac{B}{\mu_0}$ has the same dimensions as $\frac{\text{Energy}}{\text{Area} \cdot \text{Time}}$.

11-2. The great Nebula in Andromeda is one of our closest galactic neighbors. It is 2×10^6 light years away. How far is that in kilometers?

- 11-3. The capacitor is charged to $\pm Q$ Coulombs. Show that when you close the switch S the conduction current in the wire is equal to the displacement current between the capacitor plates.

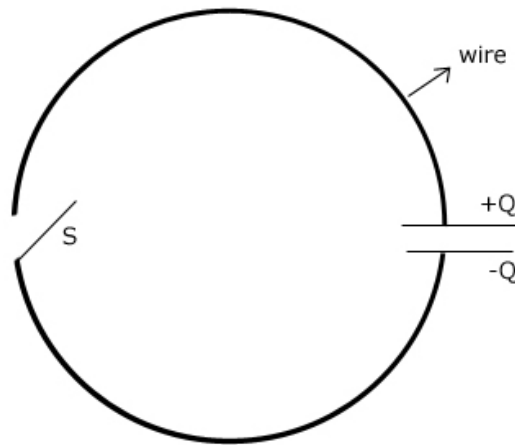

- 11-4. What is light?
- 11-5. Sound and light are both waves. List five (or more) notable differences between them.
- 11-6. What is radiation? How would you distinguish among: (i) heat radiation (ii) FM radio waves (iii) x-rays and (iv) γ (gamma)-rays?
- 11-7. The energy densities of \underline{E} and \underline{B} fields are given by

$$\eta_E = \frac{1}{2} \epsilon_0 E^2$$

$$\eta_B = \frac{B^2}{2\mu_0}, \text{ respectively}$$

What is the relationship between η_E and η_B if $E=cB$ where $c = \frac{1}{\sqrt{\mu_0 \epsilon_0}}$.

- 11-8. You are standing near a window and see a lightning flash and note that you hear the thunder 5sec later. If the speed of sound is 330m/s, how far was the flash? Why?
- 11-9. Show that $\frac{1}{\sqrt{\mu_0 \epsilon_0}}$ has the dimensions of velocity (LT^{-1}). $\epsilon_0 = 9 \times 10^{-12} \text{F/m}$, $\mu_0 = 4\pi \times 10^{-7} \text{H/m}$.
- 11-10. The intensity of em waves from the sun is $1.4 \text{ kilowatt} / \text{m}^2$ just above the Earth's atmosphere. What is the amplitude of the \underline{E} -field in these waves?

- 11-11. In a microwave oven electromagnetic waves of frequency 2.45GHz form standing waves with antinodes (burn marks on stationary food) which are about 6cm apart. What must be the velocity of the waves to produce such a pattern? Why?
- 11-12. The wavelength of red laser light is 632nm in air/vacuum. What is its frequency? If the light enters glass what happens to (i) the frequency (ii) the wavelength if the refractive index is $n = 1.457$.
- 11-13. Two perpendicular mirrors form a vessel filled with water (as shown). A light ray is incident perpendicular to the water surface. Locate the path of light after reflection from both the mirrors.

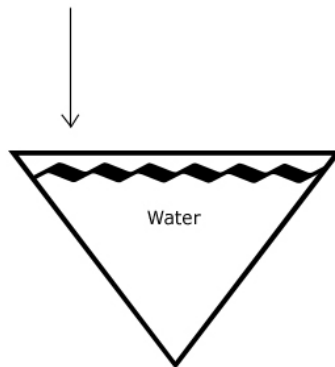

Brain power

By 2020, wind could provide one-tenth of our planet's electricity needs. Already today, SKF's innovative know-how is crucial to running a large proportion of the world's wind turbines.

Up to 25 % of the generating costs relate to maintenance. These can be reduced dramatically thanks to our systems for on-line condition monitoring and automatic lubrication. We help make it more economical to create cleaner, cheaper energy out of thin air.

By sharing our experience, expertise, and creativity, industries can boost performance beyond expectations. Therefore we need the best employees who can meet this challenge!

The Power of Knowledge Engineering

Plug into The Power of Knowledge Engineering.
Visit us at www.skf.com/knowledge



- 11-14. In the picture shown we are told that light is incident on the upper face at the critical angle.
 (i) What does it tell you about the relative values of n_1 and n_2 ? (ii) Locate the refracted ray.

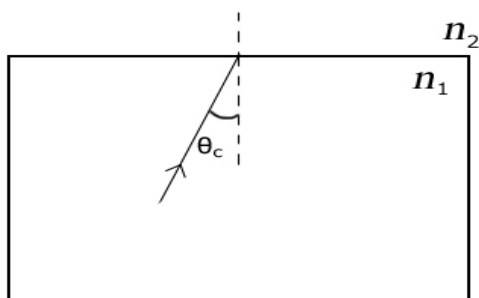

- 11-15. Show that for the picture shown, the critical angle satisfies the equation

$$\sin \Theta_c = \frac{1}{n}$$

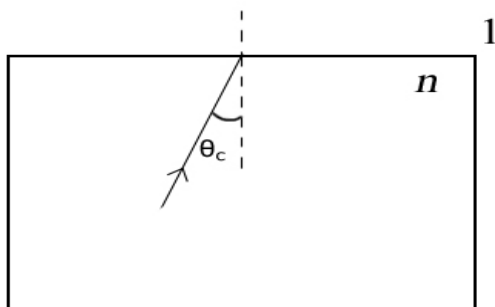

- 11-16. A point source is located 50cm below the surface of water. Calculate the diameter of the largest circle through which light can emerge from the surface. The refractive index of water is 1.33.

30.12 Problems: Week 12

Note: All solutions must be supported by ray diagrams.

- 12-1. As shown, laser light enters a room at a point 0.8m below the left top corner, reflects off the ceiling which is 2m wide and hits the opposite wall 0.3m below the top. At what point did it hit the ceiling?

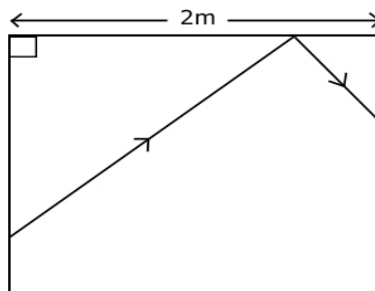

- 12-2. The object O is located as shown in “front” of two mirrors. Draw rays to locate the images that it will produce. [Hint: You need two rays to locate an image.]

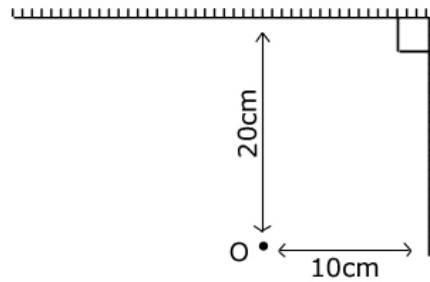

- 12-3. You drop a tiny ball from a height of 1m toward a plane mirror. How fast will its image move toward it? Why? (neglect air friction)



- 12-4. In Newton’s experiments, white light was incident on a glass prism but after passage through the prism it split into several colors. What properties of light did he learn from these experiments?

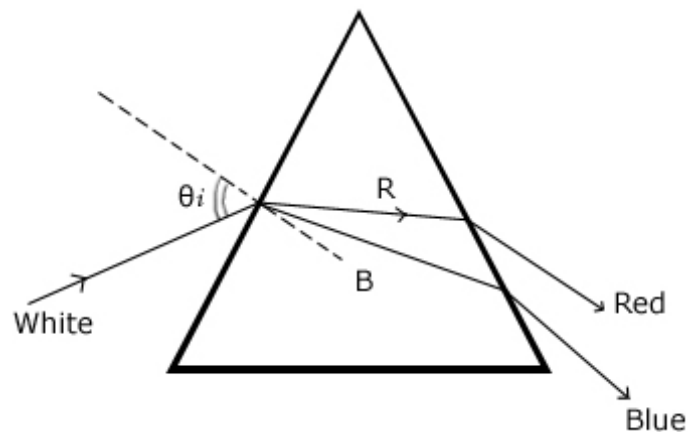

- 12-5. From the schematic shown in problem 12-4 which light (red or blue) has the larger refractive index in the prism? Why?

- 12-6. Light is incident on a parallel plate of glass of thickness t . The angle of incidence is Θ_i and the refracted ray makes the angle $\Theta_R < \Theta_i$ since $n > 1$. Eventually, it emerges parallel to its original direction. If $\Theta_i = 30^\circ$, $n = 1.5$, and $t = 10\text{cm}$ what is the “side jump” δ ?

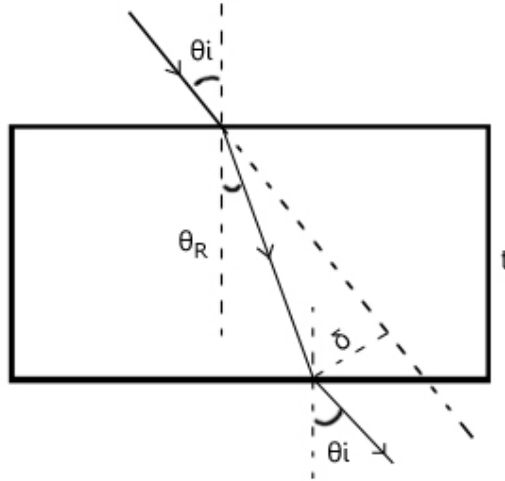

- 12-7. What is the difference between a real image and a virtual image?

What do you want to do?

No matter what you want out of your future career, an employer with a broad range of operations in a load of countries will always be the ticket. Working within the Volvo Group means more than 100,000 friends and colleagues in more than 185 countries all over the world. We offer graduates great career opportunities – check out the Career section at our web site www.volvogroup.com. We look forward to getting to know you!

VOLVO
AB Volvo (publ)
www.volvogroup.com

VOLVO TRUCKS | RENAULT TRUCKS | MACK TRUCKS | VOLVO BUSES | VOLVO CONSTRUCTION EQUIPMENT | VOLVO PENTA | VOLVO AERO | VOLVO IT
VOLVO FINANCIAL SERVICES | VOLVO 3P | VOLVO POWERTRAIN | VOLVO PARTS | VOLVO TECHNOLOGY | VOLVO LOGISTICS | BUSINESS AREA ASIA

12-8. Magnification is defined as $m = \frac{\text{image size}}{\text{object size}} = \frac{-q}{p}$ where q is the distance of the image from the optical device and p is the distance of the object. Why is there a negative sign on the right side of this equation?

12-9. For plane and spherical mirrors we have derived the equation

$$\frac{1}{p} + \frac{1}{q} = \frac{2}{r}$$

where r is the radius of curvature of the mirror. How do you distinguish among (i) a convex mirror (ii) a plane mirror and (iii) a concave mirror?

12-10. Why do you need to assume paraxial rays to prove the formula of problem 12-9 for spherical mirrors?

12-11. For a concave mirror show that a real image can never come closer to the mirror than its focal point.

12-12. (i) Can you use a convex mirror to produce a real image? (ii) Where would you locate an object to produce an image furthest from the mirror?

12-13. If you want a convergent mirror to produce an upright image where would you place the object? Why? Is the magnification greater or less than unity?

12-14. An object is placed 20cm in front of a convergent mirror and produces an inverted image one half the size of the object. What is the focal length of the mirror?

30.13 Problems: Week 13

Note: All solutions must have ray diagrams

13-1. A penny lies at the bottom of a swimming pool which is 4m deep. What is the apparent depth of the penny as viewed straight down if the refractive index of water is 1.33?

13-2. The lens maker's formula for a thin lens made of a material of refractive index n and having two spherical surfaces of radii R_F and R_B is written as

$$\frac{1}{f} = (n - 1) \left[\frac{1}{R_F} - \frac{1}{R_B} \right]$$

How do you distinguish between a convergent lens and a divergent lens? [Hint: Use the sign convention that distances measured along the path of light are positive and those against the path of light are negative]

- 13-3. Can you use a divergent lens to produce an image which is the same size as the object? Justify your answer.
- 13-4. A thin convergent lens ($f = 20\text{ cm}$) is placed on a plane mirror as shown. Where would you place the object O so that the image coincides with itself?

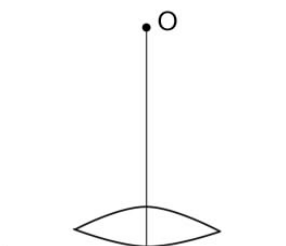

- 13-5. An object is placed a distance of 5cm from a thin convergent lens whose focal length is 10cm. Locate the image. (i) Is the image real or virtual? (ii) What is the magnification?
- 13-6. A double convex lens is made of glass ($n = 1.5$). The surfaces have radii in the ratio 1:2. If $f = 6\text{ cm}$, what are the radii? [Hint: Look at problem 13-2 again.]
- 13-7. Newton had an unusual method for writing the lens equation

$$\frac{1}{p} + \frac{1}{q} = \frac{1}{f}$$

He measured the object and image distances from the focal point and wrote

$$x = p \text{ and } x' = q - f$$

Show that this will lead to the lens equation

$$xx' = f^2$$

- 13-8. The picture shows the paths of two rays used to locate the image of a point object O. The rays are paraxial (in the picture angles are slightly exaggerated), $\alpha < 1$, $\beta < 1$. Show that $\delta = \frac{h}{f}$.

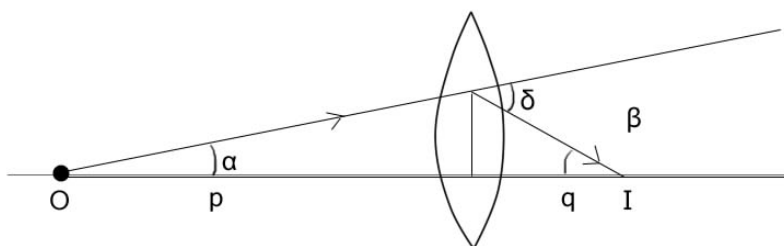

- 13-9. Considering that the emission of light involves the transition of one electron in one atom, explain why the phase of the light wave emitted by a simple lamp (not a laser) varies randomly in time?
- 13-10. When would you regard two sources of light to be incoherent?
- 13-11. If light waves from two identical but incoherent sources are superposed we observe twice the intensity due to one source. Why? [Hint: $(\sin A + \sin B) = 2 \cos\left(\frac{A-B}{2}\right) \sin\left(\frac{A+B}{2}\right)$]
- 13-12. What minimum path difference is needed to produce a phase shift of π radians in light of wavelength 600nm? What would be the phase shift of 700nm light over this distance?
- 13-13. Green light of wavelength 436nm is incident on a 580nm thick sheet of glass with refractive index 1.5. What will be the phase difference between the wave reflected from the top surface and that reflected from the bottom surface?
- 13-14. Two coherent sources of 340Hz sound are 5m apart. (i) You are standing in the middle (at 2.5m) and hear nothing (this is not a comment on your aural acuity). What does this tell you about the phase difference of the two waves at their starting points? (ii) If the speed of sound is 340m/s how many such “quiet spots” (minima) will you encounter as you walk from one source to the other?

30.14 Problems: Week 14

- 14-1. We can hear sound around a corner but no light will go around a corner. Why?
- 14-2. In a double-slit experiment using yellow light of wavelength 589nm the slits are 0.2mm, apart. What is the separation between any neighboring pair of dark fringes on a screen that is 1m away?
- 14-3. What is the difference between interference and diffraction?

- 14-4. In 2-slit interference the first minimum occurs when the path difference between the 2-waves is $\frac{\lambda}{2}$, in single slit diffraction for the first minimum the path difference between the extremal waves must be λ . Why this difference?
- 14-5. The wavelength range of visible light is from about 400nm to 700nm. If you perform a double slit experiment with a slit separation of 0.1mm, what is the range of angles separating the first maximum from the first minimum?
- 14-6. In the recent BP disaster a large quantity of oil ($n = 1.2$) spread out on the surface of water ($n = 1.33$). If you were inspecting this from a helicopter looking straight down where the slick thickness is 450nm, which wavelengths of visible light would have the greatest reflection?
- 14-7. You wish to make a non-reflecting slab of glass ($n = 1.5$) by coating it with a transparent material of ($n = 1.25$). Choosing $\lambda = 600$ nm to do so what minimum thickness of coating would you need? Why?
- 14-8. In a double-slit interference (neglect diffraction) pattern show that the intensity averaged over the entire pattern is exactly twice the intensity due to radiation from one slit.
- 14-9. In a single slit diffraction experiment using green light (436nm) the width of the first maximum on a screen 2m away is 1cm. What is the width of the slit?
- 14-10. Show that the intensities of the maxima in single-slit diffraction are in the ratio

$$1 : \frac{4}{9\pi^2} : \frac{4}{25\pi^2} : \frac{4}{49\pi^2} \dots$$